



S2770RT

S2770BE

S3370RT

S3370BE



OPERATOR'S MANUAL

Part Number 13184A
January 2011

Serial number 00000 and after

LIMITED WARRANTY

Snorkel warrants each new machine manufactured and sold by it to be free from defects in material and workmanship for a period of one (1) year from date of delivery to a Customer or for one year after the machine has been placed in first service in a Dealer rental fleet, whichever comes first. Any part or parts which, upon examination by the Snorkel Service Department, are found to be defective, will be replaced or repaired, at the sole discretion of Snorkel, through its local Authorized Dealer at no charge.

Snorkel further warrants the structural components; specifically, the mainframe chassis, turntable, booms and scissor arms, of each new machine manufactured by it to be free from defects in material and workmanship for an additional period of four (4) years. Any such part or parts which, upon examination by the Snorkel Service Department, are found to be defective will be replaced or repaired by Snorkel through its local Authorized Dealer at no charge; however, any labor charges incurred as a result of such replacement or repair will be the responsibility of the Customer or Dealer.

The Snorkel Service Department must be notified within forty-eight (48) hours of any possible warranty situation during the applicable warranty period. Personnel performing warranty repair or replacement must obtain specific approval by Snorkel Service Department prior to performing any warranty repair or replacement.

Customer and Dealer shall not be entitled to the benefits of this warranty and Snorkel shall have no obligations hereunder unless the "Pre-Delivery and Inspection Report" has been properly completed and returned to the Snorkel Service Department within ten (10) days after delivery of the Snorkel product to Customer or Dealer's rental fleet. Snorkel must be notified, in writing, within ten (10) days, of any machine sold to a Customer from a Dealer's rental fleet during the warranty period.

At the direction of the Snorkel Service Department, any component part(s) of Snorkel products to be replaced or repaired under this warranty program must be returned freight prepaid to the Snorkel Service Department for inspection. All warranty replacement parts will be shipped freight prepaid (standard ground) from the Snorkel Service Department or from Snorkel's Vendor to Dealer or Customer.

REPLACEMENT PARTS WARRANTY

Any replacement or service part made or sold by Snorkel is not subject to the preceding **Limited Warranty** beyond the normal warranty period of the machine upon which the part was installed.

THIS WARRANTY EXCLUDES AND SNORKEL DOES NOT WARRANT:

1. Engines, motors, tires and batteries which are manufactured by suppliers to Snorkel, who furnish their own warranty. Snorkel will, however, to the extent permitted, pass through any such warranty protection to the Customer or Dealer.
2. Any Snorkel product which has been modified or altered outside Snorkel's factory without Snorkel's written approval, if such modification or alteration, in the sole judgment of Snorkel's Engineering and/or Service Departments, adversely affects the stability, reliability or service life of the Snorkel product or any component thereof.
3. Any Snorkel product which has been subject to misuse, improper maintenance or accident. "Misuse" includes but is not limited to operation beyond the factory-rated load capacity and speeds. "Improper maintenance" includes but is not limited to failure to follow the recommendations contained in the Snorkel Operation, Maintenance, Repair Parts Manuals. Snorkel is not responsible for normal maintenance, service adjustments and replacements, including but not limited to hydraulic fluid, filters and lubrication.
4. Normal wear of any Snorkel component part(s). Normal wear of component parts may vary with the type application or type of environment in which the machine may be used; such as, but not limited to sandblasting applications.
5. Any Snorkel product that has come in direct contact with any chemical or abrasive material.
6. Incidental or consequential expenses, losses, or damages related to any part or equipment failure, including but not limited to freight cost to transport the machine to a repair facility, downtime of the machine, lost time for workers, lost orders, lost rental revenue, lost profits or increased cost.

This warranty is expressly in lieu of all other warranties, representations or liabilities of Snorkel, either expressed or implied, unless otherwise amended in writing by Snorkel's President, Vice President-Engineering, Vice President-Sales or Vice President-Marketing.

SNORKEL MAKES NO WARRANTIES WHICH EXTEND BEYOND THE DESCRIPTION OF THIS LIMITED WARRANTY. SNORKEL MAKES NO IMPLIED WARRANTY OF MERCHANTABILITY OR FITNESS FOR A PARTICULAR PURPOSE AND DISCLAIMS ALL LIABILITY FOR INCIDENTAL OR CONSEQUENTIAL DAMAGES, INCLUDING BUT NOT LIMITED TO INJURY TO PERSONS OR PROPERTY.

The Customer shall make all warranty claims through its local Authorized Dealer and should contact the Dealer from whom the Snorkel product was purchased for warranty service. Or, if unable to contact the Dealer, contact the Snorkel Service Department for further assistance.

■ Electrical Hazard Warning



DANGER

SR ELEVATING WORK PLATFORMS ARE NOT ELECTRICALLY INSULATED.

If the platform, scissors arm assembly, or any other conductive part of an SR contacts a high-voltage electrical conductor, the result can be **SERIOUS INJURY** or **DEATH** for persons on or near the machine.



**GO NO CLOSER THAN THE MINIMUM SAFE APPROACH DISTANCES
(M.S.A.D) - AS OUTLINED IN TABLE 1. AND FIGURE 3.,
ON THE NEXT PAGE.**

Be sure to allow for sag and sway in the wires and the work platform.

If an SR comes in contact with a live electrical conductor, the entire machine can be charged.

If that happens, you should remain on the machine and not contact any other structure or object within reach. That includes the ground, adjacent buildings, poles, and any object not a part of the SR.

Such contact could make your body a conductor to the other object creating an electrical shock hazard resulting in **SERIOUS INJURY** or **DEATH**.

DO NOT attempt to enter or leave the SR until you are sure the electricity has been turned off.

If an SR is in contact with a live conductor, the platform operator **MUST** warn others on the ground in the vicinity of the SR to **STAY AWAY** from the machine, since their bodies can also form a path for electricity to ground thus creating an electrical shock hazard with possible **ELECTROCUTION** and **DEATH**.

DO NOT attempt to operate SR ground controls when the platform, scissors arm assembly, or any other conducting part of the SR is in contact with electrical wires or if there is an immediate danger of such contact.

Regard all conductors as energized.

Personnel working on or near an SR must be continuously aware of electrical hazards, recognizing that **SERIOUS INJURY** or **DEATH** can result if contact with an electrical wire does occur.

Electrical Hazard

■ Minimum Safe Approach Distance

An SR is an all metal **NOT ELECTRICALLY INSULATED**, aerial work platform. **DO NOT** operate it near **ELECTRICAL** conductors. Regard all conductors as being energized. Use the table and illustration below to determine safe clearance from electrical conductors. (Table 1 and Figure 3, below, are from ANSI/SIA A92.6–1990 Standard, reprinted with permission of Scaffold Industry Association.)

□ Table 1 - (M.S.A.D.)

**Minimum Safe Approach Distance
to energized (exposed or insulated power lines)**

Voltage range (phase to phase)	Minimum safe approach distance	
	(Feet)	(Meters)
0 to 300V	Avoid contact	
over 300v to 50kv	10	3.05
over 50kv to 200kv	15	4.60
over 200kv to 350kv	20	6.10
over 350kv to 500kv	25	7.62
over 500kv to 750kv	35	10.67
over 750kv to 1000kv	45	13.72

□ Figure 3 - (M.S.A.D.)

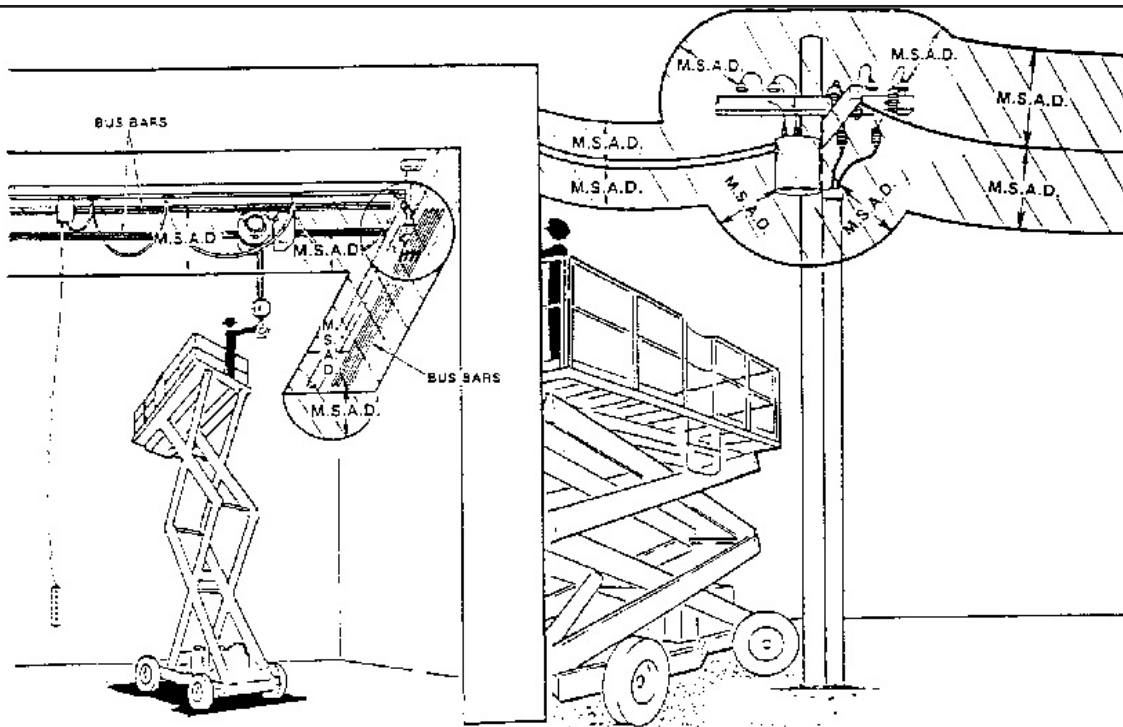

Denotes prohibited zone

- Danger:**
- Do not allow machine personnel or conductive materials inside prohibited zone.
 - Maintain M.S.A.D. From all energised lines and parts as well as those shown.
 - Assume all electrical parts and wires are energised unless known otherwise.
- Caution:**
- Diagrams shown are only for purposes of illustrating M.S.A.D. Work positions, not all work positions.

The most important chapter in this manual is the safety chapter - Chapter 1. Take time, now, to study it closely.

The information in Chapter 1, might save your life, prevent serious injury, or damage to property or the SR3370 / SR2770.

This introduction also contains important information concerning the responsibilities of the owner of the machine.

■ Standard SR3370 / SR2770 Version 2

The standard SR3370 / SR2770 includes the following features:

- Fully proportional one handed joy stick control
- Reliable diesel engine
- Large 1200mm multi position extension deck
- 35% gradeability
- 4 wheel drive
- Hour meter
- Temperature & ammeter gauges
- Easy access side trays for engine & hydraulics
- Lockable hinged covers
- Independently operated hydraulic stabilisers with auto level
- Swinging gate
- Independent articulating rear axles
- Forklift pockets
- Lifting lugs and tie down rings
- Flashing light

■ Options

The following options are available for the SR3370 / SR2770:

- No stabilisers
- Non-marking tyres
- 110/240V power to platform
- RCD/ELCB Outlet
- Alternative power options
 - Gasoline engine
 - LPG engine
 - Combination LPG/Gasoline engine
 - Bi-Energy 24V DC / Diesel engine

■ Operation Manual

This manual provides information for safe and proper operation of the aerial platform. Read and understand the information in this Operator's manual before operating this machine on a job site.

Additional copies of this manual may be ordered from Snorkel. Supply the model and manual part number from the front cover to assure that the correct manual will be supplied.

All information in this manual is based on the latest product information at the time of publication. Snorkel reserves the right to make product changes at any time without obligation.

■ Photographs

Photographs are taken to represent the machine and its component parts as clearly as possible. However, there may be minor differences between the photographs and your machine. This represents individual customer preferences and Snorkel's on-going commitment to product development.

■ Safety Alerts

A safety alert symbol is used throughout this manual to indicate danger, warning and caution instructions. Follow these instructions to reduce the likelihood of personal injury, property damage or damage to the machine.

The terms danger, warning, and caution indicate varying degrees of personal injury or property damage that can result if the instruction is not followed.

▲ DANGER

Denotes an imminently hazardous situation which, if not avoided, will result in death or serious injury.

▲ WARNING

Denotes a potentially hazardous situation which, if not avoided, could result in death or serious injury.

▲ CAUTION

Denotes a potentially hazardous situation which, if not avoided, may result in minor or moderate injury.

It may also be used to alert against unsafe practices or action which may result in damage to the SR.

▲ IMPORTANT

Denotes important information pertaining to settings, capacities, conditions, which could, if ignored lead to machine damage or future hazardous situations.

Introduction

It is also used to alert the reader to pay careful attention to a particular passage of text in the manual.

Notes

Notes are used to provide special information or helpful hints to assist in aerial platform operation, but do not indicate a hazardous situation.

■ Operation

The SR aerial platform has built in safety features and has been factory tested for compliance with Snorkel specifications and industry standards. However, any personnel lifting device can be potentially dangerous in the hands of untrained or careless operators.

Training is vitally important and must be performed under the direction of a QUALIFIED person. You must display proficiency in knowledge and actual operation of the SR before using it on a job site.

Before operation of the SR you must read and understand the operating instructions in this manual as well as the decals, warnings, and instructions on the machine itself.

Before operating the SR you must be AUTHORIZED by the person in charge to do so and the operation of the SR must be within the scope of the machine specifications.

▲ WARNING

The potential for an accident increases when the aerial platform is operated by personnel who are not trained and authorised. Death or serious injury can result from such accidents.

Read and understand the information in this manual and on the placards and decals on the machine before operating the SR on the job site.

■ Maintenance

Every person who maintains, inspects, tests, or repairs these machines, and every person supervising any of these functions, must be properly trained and qualified to do so.

This Operators Manual provides a daily inspection procedure that will help you keep your SR in good operating condition.

Do not perform other maintenance unless you are a trained mechanic, qualified to work on the SR. Call qualified maintenance personnel if you find problems or malfunctions.

Do not modify this machine without written approval from the Engineering Department of Snorkel. Modification may void the warranty, adversely affect stability, or affect the operational characteristics of the SR.

■ Responsibilities of parties

It is imperative that all owners and users of the SR read, understand, and conform to all applicable regulations. Ultimate compliance to OSHA regulations is the responsibility of the user and their employer.

▲ IMPORTANT

It is imperative that all owners and users of the SR read, understand, and conform to all applicable regulations.

Ultimate compliance to OSHA regulations is the responsibility of the user and their employer.

▲ IMPORTANT

ANSI Standard A92.6 clearly identifies requirements of all parties who might be involved with Self-Propelled Elevating Work Platforms.

AUSTRALIAN / NZ STANDARD 2550-10 also identifies the requirements of all parties who might be involved with Boom-Supported Elevating Work Platforms.

Note - Standards

It is the responsibility of the owner to ensure that the person operating the SR3370 / SR2770 is provided with all the relevant information relating to standards and codes of practice applicable in their region.

□ In summary

- Only trained and authorised operators should be permitted to operate the equipment.
- All manufacturers operating instructions and safety rules and all employers safety rules and all OSHA and other government safety rules should be strictly adhered to.
- Repairs and adjustments should be made only by qualified and trained maintenance personnel.
- No modification should be made to the equipment without prior written consent of the Snorkel Engineering Department.
- Make a pre-start inspection of the SR at the beginning of each shift. A malfunctioning machine must not be used.

- Make an inspection of the work place to locate possible hazards before operating the SR.

■ Additional information

For additional information, contact your local dealer or Snorkel at:

Snorkel New Zealand,
PO Box 1041
Levin 5510
New Zealand

Electrical Hazard

Electrical Hazard Warning	i
Minimum Safe Approach Distance	ii
Table 1 - (M.S.A.D.)	ii
Figure 3 - (M.S.A.D.)	ii

Introduction

Standard SR3370 / SR2770 Version 2	iii
Options	iii
Operation Manual	iii
Photographs	iii
Safety Alerts	iii
Operation	iv
Maintenance	iv
Responsibilities of parties	iv
Additional information	v

1. Safety

Safe Operation	1-1
Electrocution Hazards	1-1
Minimum safe approach distance	1-1
Pre-start Inspection	1-2
Work Place Inspection and Practices	1-2
Operation	1-3
Tipover and Falling Hazards	1-3
General Safety Precautions	1-3
Hydraulic System Precautions	1-3
Fire Prevention	1-4
Engine and Fuel Handling Precautions	1-4
Batteries	1-4
Safety Decals and Placards	1-4
Safety Placards and Decals Location	1-5

2. Safety Devices

Safety Device Information	2-1
Emergency Stop Switches	2-1
At platform control box	2-1
At ground control box	2-1
Alarms	2-1
Level sensor	2-2
Lowering	2-2
High temperature	2-2
Low oil pressure	2-2
Drive (reverse)	2-2
Drive (forward)	2-2
Guardrails	2-2
Safety Prop	2-2
Swinging Gate	2-2
Safety Control	2-3
Bubble Level	2-3
Operator Horn	2-3
Stabilisers (Option)	2-3
RCD/ELCB AC Outlet (option)	2-3

Flashing Light (option)	2-4
Lanyard Anchor Points (option)	2-4

3. Specifications

Specifications	3-1
General Specifications, Standard Machine SR3370	3-1
Recommended Hydraulic Oil	3-1
General Specifications, Standard Machine SR2770	3-2
Engine Oil Charts	3-3
Engine Data	3-3
DF752	3-3
D902	3-3
Machine Component Identification	3-4

4. Gauges

Water	4-1
Amps	4-1
Engine Oil	4-1
Hydraulic Oil Level	4-1
Hours	4-2
Fuel Level (option)	4-2
Bubble Level	4-2

5. Automatic Shut-offs and Circuit Breakers

Automatic Shut-offs	5-1
Level sensor	5-1
Engine temperature	5-1
Engine oil pressure	5-1
Platform height vs. drive speed	5-1
Dynamic brakes	5-1
Alternator not charging	5-1
Stabilisers	5-1
Circuit Breakers	5-2
Main breaker	5-2
RCD / ELCB outlet (option)	5-2

6. Controls

Controls	6-1
Hydraulic Compartment	6-1
Ground Control Box	6-1
Platform Control Box	6-2

7. Daily Inspection and Maintenance

Daily Inspection and Maintenance Table	7-1
Fuel Level	7-2
(LPG - Option)	7-2
Fuel Filter (diesel engines only)	7-2
Fuel Leaks	7-2
Engine Oil	7-3
Engine Coolant	7-3
Radiator Cap	7-3

Table of Contents

Swinging Gate	7-3
Wiring Harnesses and Connectors	7-3
Battery Terminals	7-4
Battery Fluid Level	7-4
Hydraulic Oil Tank	7-4
Hydraulic tank cap	7-4
Hydraulic oil level	7-4
Hydraulic Oil Leaks	7-4
Tires and Wheels	7-5
Bolts and Fasteners	7-5
Structural Damage & Welds	7-6
Guardrails	7-6
Bubble Level	7-6
Guides, rollers, and slides	7-6
Charging System	7-7
Ground Controls	7-7
Flashing Light	7-7
Platform Controls	7-7
Emergency Lowering	7-8
RCD / ELCB (Option)	7-8
Safety prop	7-8
Lanyard Anchorages (Option)	7-8
Non-Slip Tread Grip	7-8
Wrist Support	7-9
Operator Manual	7-9
Placards and Decals	7-10
Standard placards and decals	7-10
Inspection drawing	7-11

8. Operation

Operating Procedures	8-1
Control Stations	8-1
Emergency Stopping	8-1
Operation Considerations	8-1
Fuel type	8-2
Operating From The Ground Control Box	8-2
Raising the platform	8-3
Operating From The Platform Control Box	8-4
Driving	8-6
Raising the Platform	8-7
Stabilisers	8-7
Operating The Stabilisers Manually	8-8
To set the stabilisers	8-8
To raise the stabilisers:	8-8
Operating The Auto Level System	8-9
Setting the stabilisers automatically	8-9
Raising the stabilisers automatically	8-9
Extending The Multi-Position Platform	8-9

9. Emergency Operation

Emergency Operation Procedures	9-1
Emergency Stop	9-1
Emergency Bleed-Down	9-1

Pushing / Towing	9-2
------------------	-----

10. Stowing and Transporting

Stowing	10-1
Transporting	10-2
Trailing	10-2
Securing to a Transport Vehicle	10-2
Towing	10-3
Lifting / Lashing Down	10-3
Pushing	10-3
Winching Procedure	10-3

11. Options

Bi-Energy Option	11-1
DC motor	11-1
DC motor operation	11-1
Master battery isolater switches	11-1
Steering in DC motor mode	11-2
Batteries	11-2
Battery charger	11-2
Batteries - General maintenance	11-3
Batteries - Charging	11-3
RCD / ELCB Outlet	11-3
Flashing Light	11-3
Lanyard Anchor Points	11-4
Electrical Outlet	11-4
Non-Marking Tyres	11-4
Alternative Power Options	11-4
Stabilisers	11-4

12. Fire Fighting and Chemical Containment

Hazardous Components	12-1
Antifreeze (UN 1993)	12-1
Battery, Lead/Acid (UN 2794)	12-1
Diesel Fuel (NA 1993)	12-1
Foam In Tires	12-2
Gasoline (UN 1203)	12-2
Hydraulic Oil (UN 1270)	12-3
Liquefied Petroleum Gas (UN 1075)	12-3
Motor Oil (UN 1270)	12-3

13. Operator's Troubleshooting

Troubleshooting	13-1
Operator Troubleshooting Chart	13-1

Appendix A. Glossary

■ Safe Operation

Knowledge of the information in this manual, and proper training, provide a basis for safely operating the SR3370 / SR2770. Know the location of all the controls and how they operate to act quickly and responsibly in an emergency.

Safety devices reduce the likelihood of an accident. Never disable, modify, or ignore any safety device. Safety alerts in this manual indicate situations where accidents may occur.

If any malfunction, hazard or potentially unsafe condition relating to capacity, intended use, or safe operation is suspected, stop the operation of the SR and seek assistance.

The operator bears ultimate responsibility for following all manufacturers instructions and warnings, regulations and safety rules of their employer and/or any country or regional law.

■ Electrocution Hazards

The SR is an all metal aerial work platform and is not electrically insulated. Do not operate it near electrical conductors. Regard all conductors as being energized. Do not operate outside during a thunderstorm.

□ Minimum safe approach distance

Minimum safe approach distances to energized power lines and their associated parts must be observed while operating the SR.

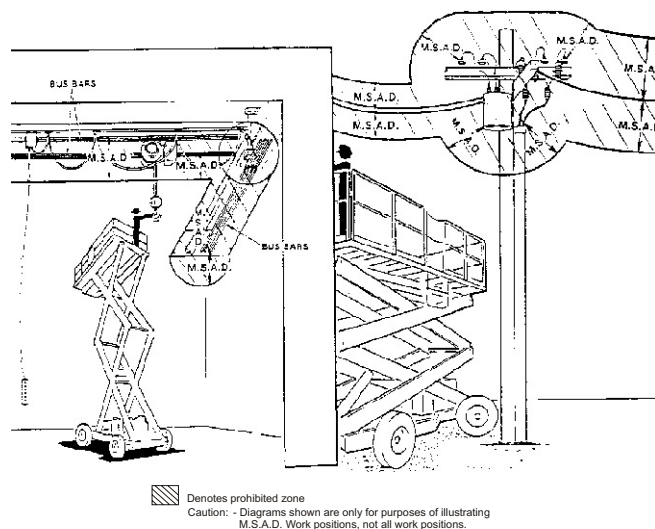

Figure 1. - Minimum Safe Approach Distance

▲ DANGER

The SR is not electrically insulated. Death or serious injury can result from contact with, or inadequate clearance from, an energised conductor. Do not go closer than the minimum safe approach distance as defined by ANSI.

ANSI publications define minimum distances that must be observed when working near bus bars and energised power lines. Figure 1 and Table 1 are reprinted courtesy of the Scaffold industry Association, ANSI/SIA A92.5.

Voltage Range (Phase to Phase)	Minimum Safe Approach Distance	
	Feet	Metres
0 to 300V	Avoid Contact	
Over 300V to 50kV	10	3.05
Over 50kV to 200kV	15	4.60
Over 200kV to 350kV	20	6.10
Over 350kV to 500kV	25	7.62
Over 500kV to 750kV	35	10.7
Over 750kV to 1000kV	45	13.72

Table 1. - Minimum Safe Approach Distance

Australian Standard AS 2550.10 defines minimum distances that must be observed when working near live aerial conductors up to and including 133kV (see Figure 2).

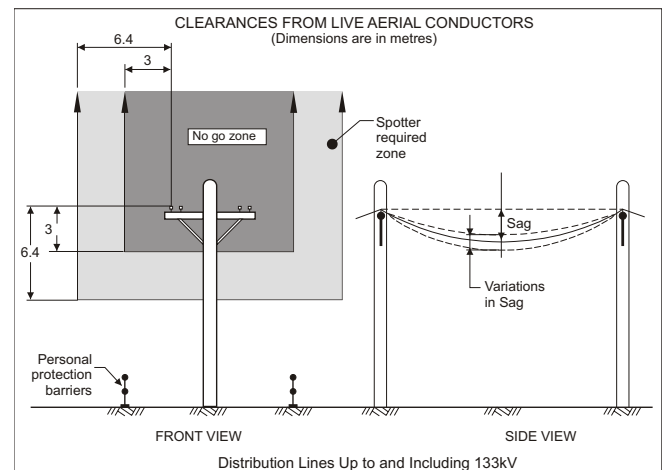

Figure 2 - Minimum Safe Approach Distance AS 2550.10

1. Safety

■ Pre-start Inspection

At the start of each work shift, the SR3370 / SR2770 shall be given a visual inspection and function test. See the Daily Inspection and Maintenance chapter , in this manual for a list of items to inspect and test.

▲ WARNING

DO NOT operate the SR3370 / SR2770 unless you are trained and authorized, understand the operation characteristics of the SR3370 / SR2770, and have inspected and tested all functions to be sure they are in proper working order.

■ Work Place Inspection and Practices

Do not use the SR3370 / SR2770 as a ground for welding. Ground to the work piece.

Before the SR3370 / SR2770 is used, and during use, check the area in which the SR3370 / SR2770 is to be used for possible hazards such as, but not limited to:

- Drop-offs or holes.
- Side slopes.
- Bumps and floor obstructions.
- Debris.
- Overhead obstructions and electrical conductors.
- Hazardous locations.
- Inadequate surface and support to withstand all load forces imposed by the aerial platform in all operating configurations.
- Wind and weather conditions.
- Presence of unauthorized persons.
- Other possible unsafe conditions.

Before the SR3370 / SR2770 is used, determine the hazard classification of any particular atmosphere or location according to ANSI/NFPA 505-1987.

Any SR3370 / SR2770 operated in a hazardous location must be approved and of the type required by ANSI/NFPA 505-1987.

While operating the SR a recommended safety practice is to have trained and qualified personnel in the immediate work area of the SR3370 / SR2770 to:

- Help in case of an emergency.
- Operate emergency controls as required.

- Watch for loss of control by platform operator.
- Warn the operator of any obstructions or hazards that may not be obvious to them.
- Watch for soft terrain, sloping surfaces, drop-offs, etc., where stability could be jeopardized.
- Watch for bystanders and never allow anyone to be under, or to reach through the booms while operating the aerial platform.

▲ DANGER

Pinch points may exist between moving components. Death or serious injury can result from becoming trapped between components, buildings, structures, or other obstacles. Make sure there is sufficient clearance around the machine before moving the chassis, booms, or platform. Allow sufficient room and time to stop movement to avoid contact with structures or other hazards.

Keep ground personnel from under the platform when the platform is raised.

Secure all accessories, containers, tools, and other materials in the platform to prevent them from accidentally falling or being kicked off the platform.

Always look in the direction of travel. Drive with care and at speeds compatible with the work-place conditions. Use caution when driving over rough ground, on slopes, and when turning.

Do not engage in any form of horseplay or stunt driving while operating the SR3370 / SR2770.

Do not permit riders on the machine anyplace other than on the platform.

Remove all loose objects stored in or on the machine, particularly in the platform. Remove all objects which do not belong in or on the machine.

Never steady the platform by positioning it against another platform.

Do not operate an SR3370 / SR2770 that is damaged or not functioning properly. Do not use the SR until the machine has been repaired by a qualified maintenance person.

Do not operate a SR3370 / SR2770 that does not have all its decals and placards attached and legible.

Watch for bystanders and never allow anyone to be under, or to reach through, the machine and its equipment while operating.

Use the recommended transport device when loading the machine.

■ Operation

If you encounter any suspected malfunction of the aerial platform, or any hazard or potentially unsafe condition relating to capacity, intended use, or safe operation, cease operation immediately and seek assistance from management.

Use three points of support when getting on or off the platform (two hands and one foot or a similar set of points). Keep the platform clean.

Maintain a firm footing on the platform floor. Operate the controls slowly and deliberately to avoid jerky and erratic operation. Always stop the controls in neutral before going in the opposite direction.

Do not dismount while the platform is in motion or jump off the machine.

Do not start until all personnel are clearly away from the machine.

Never cover the floor grating or otherwise obstruct your view below. Make sure the area below the platform is free of personnel before lowering.

■ Tipover and Falling Hazards

Operate the SR only on a firm, flat, level surface capable of withstanding all load forces imposed by the SR3370 / SR2770 in all operating conditions.

▲ DANGER

The SR can tip over if it becomes unstable. Death or serious injury can result from a tip-over accident. Do not drive or position the SR platform for elevated use near any drop-off, hole, slope, soft or uneven ground, or other tip-over hazard.

Do not operate the SR3370 / SR2770 from a position on trucks, trailers, railway cars, floating vessels, scaffolds, or similar equipment unless the application is approved in writing by Snorkel.

Care shall be taken to prevent rope, electric cords, and hoses, etc., from becoming entangled in the aerial platform. If the platform or elevating assembly becomes caught, snagged, or otherwise prevented from normal motion by an adjacent structure or other obstacle such that control reversal does not free the platform, remove all personnel from the platform before attempts are made to free the platform using ground controls.

Under normal working conditions it is best not to transfer from the platform to another structure or

vice versa, unless that is the safest way to do the job. Each situation must be judged separately taking the work environment into account. The following guidelines apply:

1. Where possible, place the work platform over a roof or walking structure to do the transfer.
2. Transfer your anchorage from one structure to another before you step across.
3. Remember, you might be departing the work platform to a structure where fall arrest is required.
4. Do not climb over or through the guardrails. Use the platform entrance.

All platform occupants **MUST** wear and use fall restraint. Attach fall restraints to the platform lanyard anchor points.

Do not exceed the unrestricted platform capacity as indicated on the capacity placard at the entrance to the platform. Do not carry loads from any point outside of the platform.

Make sure that all protective guards, cowlings, and doors are in place and secure. Be sure the guard-rail system, including the gate, is in place and secure.

Do not climb on the guardrails or use ladders, planks, or other devices to extend or increase your work position from the platform.

Do not use the SR as a crane, hoist, or jack, or for any other purpose other than to position personnel, their tools, and materials.

Do not operate the SR3370 / SR2770 in winds, or wind gusts, of 28 mph, 45kph 12.5 m/s) or more.

▲ DANGER

Do not add banners, flags, screens or shelters etc., to areas of the SR that are exposed to wind forces as this will increase the wind loading and effect stability.

■ General Safety Precautions

Do not modify the SR3370 / SR2770 in any way.

When parts or components are replaced, they shall be identical or equivalent to original Snorkel parts or components.

Do not override any of the safety features of the SR3370 / SR2770.

■ Hydraulic System Precautions

The hydraulic system contains hoses with hydraulic fluid under pressure.

1. Safety

▲ DANGER

Hydraulic fluid escaping under pressure can have enough force to inject fluid into the flesh. Serious infection or reaction can result if medical treatment is not given immediately. In case of injury by escaping hydraulic fluid, seek medical attention at once.

DO NOT place your hand or any part of your body in front of escaping hydraulic fluid. Use a piece of cardboard or wood to search for hydraulic leaks.

Do not attempt repairs to hydraulic systems unless you are trained. Refer to experienced repair personnel for help.

■ Fire Prevention

Never operate your SR near a flame or spark. Hydraulic oil and gasoline are flammable and can explode.

■ Engine and Fuel Handling Precautions

▲ DANGER

Engine exhaust contains carbon monoxide, a poisonous gas that is invisible and odorless. Breathing engine exhaust fumes can cause death or serious illness. Do not run the engine in an enclosed area or indoors without adequate ventilation.

Only refuel your SR outdoors in a clear area void of gas fumes or spilled gas. Never remove the fuel cap or refuel a gasoline engine while the engine is running or hot. ALWAYS allow the engine to cool before refueling. Never allow fuel to spill on hot machine components.

▲ CAUTION

DO NOT smoke or permit open flames while fueling or near fueling operations.

Maintain control of the fuel filler nozzle when filling the tank.

▲ WARNING

ENSURE you use an approved fuel container with appropriate fuel filler nozzle

Do not fill the fuel tank to capacity. Allow room for expansion.

If gasoline is spilled, clean up spilled fuel immediately, push/tow the SR away from the area of the spill and avoid creating any source of ignition until the spilled fuel has evaporated.

Tighten the fuel tank cap securely. If the fuel cap is lost, replace it with an approved cap from Snorkel. Use of a non-approved cap without proper venting may result in pressurization of the tank.

Never use fuel for cleaning purposes.

For diesel engines, use the correct fuel grade for the operating season.

■ Batteries

Charge batteries in a well ventilated area free of flame, sparks, or other hazards that might cause fire or explosion.

▲ WARNING

Batteries give off hydrogen and oxygen that can combine explosively. Death or serious injury can result from a chemical explosion. Do not smoke or permit open flames or sparks when checking batteries.

Battery acid can damage the skin and eyes. Serious infection or reaction can result if medical treatment is not given immediately. Wear face and eye protection when working near batteries.

Batteries contain sulfuric acid that can damage your eyes or skin on contact. Wear a face shield, rubber gloves, and protective clothing when working around batteries. If acid contacts your eyes, flush immediately with clear water and get medical attention. If acid contacts your skin, wash off immediately with clear water.

■ Safety Decals and Placards

There are several safety decals and placards on the SR3370 / SR2770. Their locations and descriptions are shown in this section. Take time to study them.

▲ CAUTION

Be sure that all the safety decals and placards on the SR3370 / SR2770 are legible. Clean or replace them if you cannot read the words or see the pictures. Clean with soap & water and a soft cloth. Do not use solvents.

You MUST replace a decal or placard if it is damaged, missing, or cannot be read. If it is on a part that is replaced, make sure a new decal or placard is installed on the replaced part. See your Snorkel dealer for new decals and placards.

■ Safety Placards and Decals Location

LEFT HAND SIDE OF THE SR

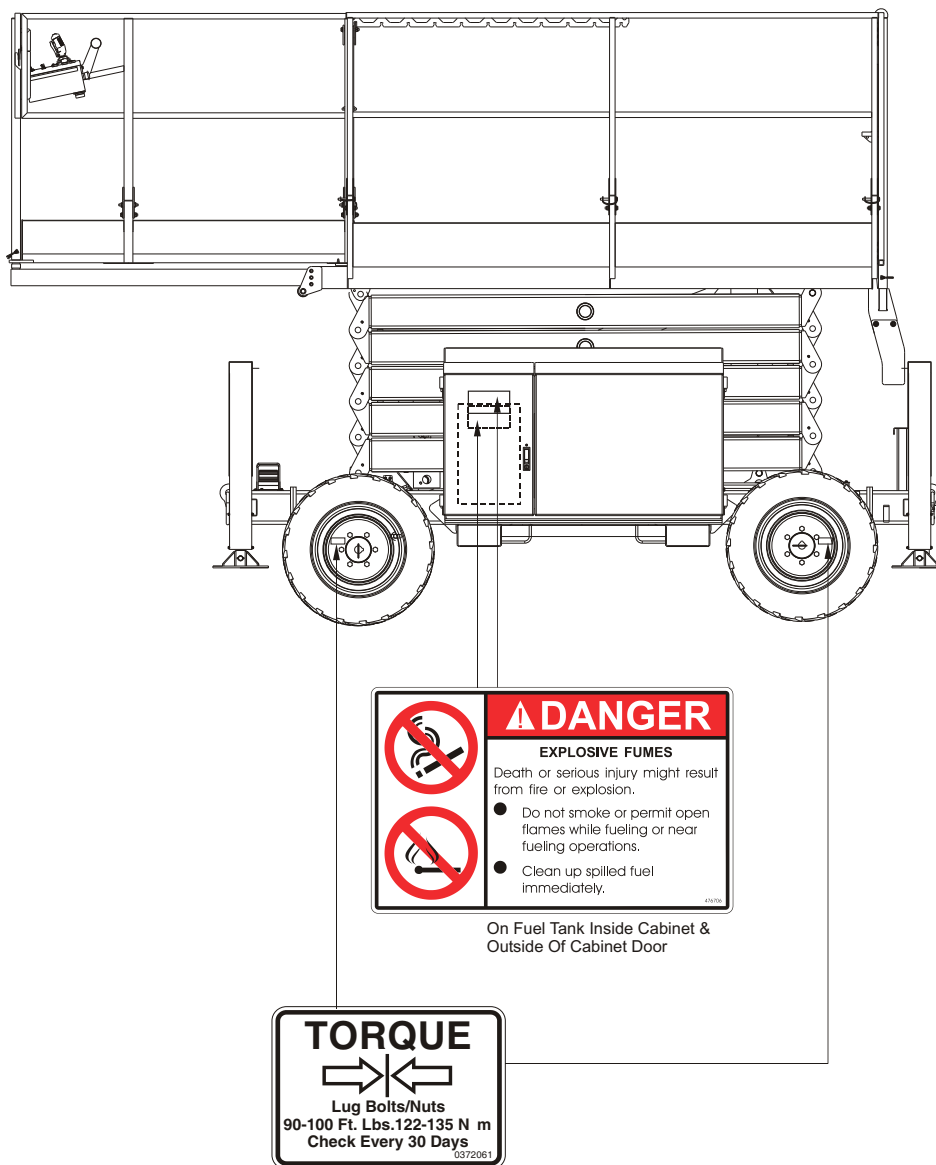

1. Safety

RIGHT-HAND SIDE OF SR



⚠ DANGER
SHEARING HAZARD/CRUSHING HAZARD
 Death or serious injury might result from having body parts sheared or crushed as the platform descends. Keep away from closing scissor arms and keep out from under the platform as the platform comes down.

300700

EMERGENCY OPERATION

1. EMERGENCY LOWERING
 In the event of total power failure pull the emergency lowering handle mounted at the front of the chassis until the platform starts to descend. Once the platform is lowered the handle can be released.

2. TOWING OR PUSHING THE SR

⚠ DANGER
 A runaway SR can cause Death or serious injury. Do not proceed unless the SR is on a level surface or is attached to an object that can hold the SR on a slope.

⚠ CAUTION
 The SR Drive motors will be ruined if the SR is pushed or towed faster than 3.2 kph (2 mph).

In order to push or tow the SR the following steps MUST be taken.

Freewheel the Drive Motors
 Turn the FREEWHEEL knob [A] Counterclockwise fully.

Release the Brakes
 Pump the hand pump [B] 5 to 10 times or until the Brakes are released.

After the SR has been pushed or towed the Brakes and the Drive Motors MUST be re-set.
 To re-set the Brakes pull knob [C] until it is fully open.

To re-set the Drive Motors turn the FREEWHEEL knob [A] clockwise until it is fully closed.

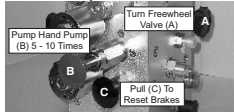

13370

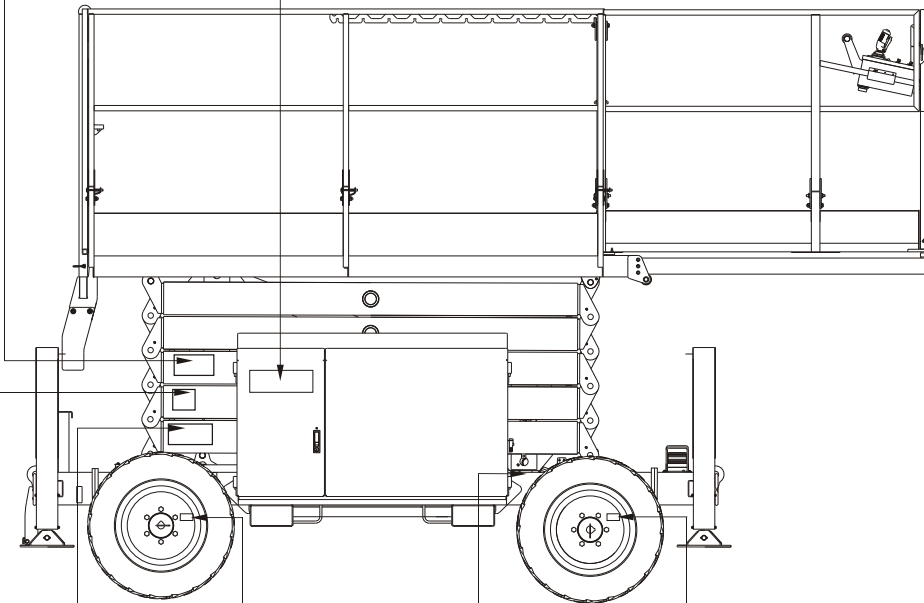

⚠ DANGER

YOU MUST NOT OPERATE THIS DEVICE UNLESS:

1. YOU HAVE BEEN TRAINED IN THE SAFE OPERATION OF THIS DEVICE AND
2. YOU KNOW AND FOLLOW THE SAFETY AND OPERATING RECOMMENDATIONS CONTAINED IN THE MANUFACTURER'S MANUALS, YOUR EMPLOYER'S WORK RULES, AND APPLICABLE GOVERNMENTAL REGULATIONS.

AN UNTRAINED OPERATOR SUBJECTS HIMSELF AND OTHERS TO DEATH OR SERIOUS INJURY.

0323897

TORQUE



Lug Bolts/Nuts
 90-100 Ft. Lbs. 122-135 N m
 Check Every 30 Days

0372061

⚠ DANGER

DO NOT ALTER OR DISABLE LIMIT SWITCHES, SAFETY SWITCHES, OR INTERLOCKS.

⚠ DANGER

DEATH OR SERIOUS INJURY MAY RESULT IF SAFETY BAR IS NOT USED AND OR PROPERLY POSITIONED. USE SAFETY BAR AT ALL TIMES WHEN SERVICING MACHINE WITH PLATFORM RAISED.

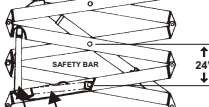

STORAGE POSITION
 PROPER POSITION FOR USE

24"

PROPER USE OF SAFETY BAR

- * REMOVE ALL MATERIAL FROM PLATFORM
- * RAISE PLATFORM UNTIL THE OPEN HEIGHT BETWEEN CENTER PINS IS APPROXIMATELY 24 INCHES.
- * SWING SAFETY BAR UP FROM STORAGE POSITION.
- * REMOVE HANDS AND ARMS FROM SCISSORS AREA.
- * LOWER PLATFORM UNTIL SCISSORS ARE SUPPORTED BY SAFETY BAR.

TO STORE SAFETY BAR

- * RAISE PLATFORM UNTIL THE OPEN HEIGHT BETWEEN CENTER PINS IS APPROXIMATELY 24 INCHES.
- * SWING BAR DOWN TO STORAGE POSITION.

TORQUE



Lug Bolts/Nuts
 90-100 Ft. Lbs. 122-135 N m
 Check Every 30 Days

0372061

FRONT END OF SR

DANGER

BEWARE OF ELECTRICAL HAZARDS

REGULATION 133A OF THE
CONSTRUCTION SAFETY ACT 1912 REQUIRES

<p>(a) Minimum approach of an appliance to live electrical apparatus.</p> <p>(b) Inspection of the work site for electrical hazards before commencing to use the appliance.</p> <p>(c) Constant vigilance and an observer required whilst working or travelling the appliance in the vicinity of live electrical apparatus.</p>	<p>3m. for voltages up to 132,000 6m. for voltages above 132,000 and up to 330,000 8m. for voltages above 330,000</p>
---	---

Australia Only

WARNING

KEEP CLEAR OF POWER LINES

Unless the Electrical Supply Authority has advised in writing otherwise;

the clearance between any live overhead power line and any part of this machine or load carried is required by law to be

AT LEAST 4 METRES

This is a requirement of regulation 93 of the Electrical Supply Regulations 1984 in the interests of safe working.

New Zealand Only

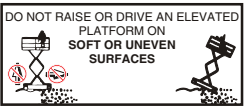
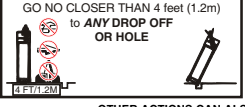
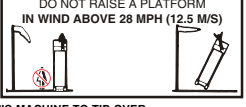

DANGER

DEATH OR SERIOUS INJURY CAN RESULT FROM TIPPING OVER.
TO KEEP FROM TIPPING THIS MACHINE OVER FOLLOW THESE RULES.

<p style="font-size: 8px; text-align: center;">DO NOT RAISE OR DRIVE AN ELEVATED PLATFORM ON A SLOPE</p> 	<p style="font-size: 8px; text-align: center;">DO NOT RAISE OR DRIVE AN ELEVATED PLATFORM ON SOFT OR UNEVEN SURFACES</p> 
<p style="font-size: 8px; text-align: center;">GO NO CLOSER THAN 4 feet (1.2m) to ANY DROP OFF OR HOLE</p> 	<p style="font-size: 8px; text-align: center;">DO NOT RAISE A PLATFORM IN WIND ABOVE 28 MPH (12.5 M/S)</p> 

OTHER ACTIONS CAN ALSO CAUSE THIS MACHINE TO TIP OVER

<p>DO NOT override safety devices.</p> <p>DO NOT overload the machine.</p> <p>DO NOT stand or sit on guardrails.</p> <p>DO NOT attach ropes or chains to guardrails.</p> <p>DO NOT carry loads outside the railing or use as a crane.</p>	<p>DO NOT ride platform while machine is on a truck, fork lift or other device.</p> <p>DO NOT use ladder, scaffold, or other means to increase size or platform height.</p> <p>DO NOT use with improperly inflated or damaged tires or wheels.</p>
--	---

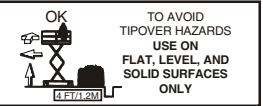
<p style="font-size: 8px; text-align: center;">TWO-TONE ALARM MEANS TIPOVER DANGER! LOWER PLATFORM IMMEDIATELY</p> <ol style="list-style-type: none"> 1.  2.  3.  	<p style="font-size: 8px; text-align: center;">TO AVOID TIPOVER HAZARDS USE ON FLAT, LEVEL AND SOLID SURFACES ONLY</p> 
--	--

DO NOT use this machine without the railings and the entry gate in place. You could fall out and hurt or kill yourself.

DO NOT let an untrained or unauthorized person use this machine. When you leave the machine unattended, remove the key, or turn off the battery switch on the base of the machine and lock the battery switch in the off position.

DO NOT use this machine if it is not operating correctly, or if any part of it is damaged, worn, or missing. An accident could cause injury or death.

DO NOT replace components critical to machine stability, such as batteries and wheel equipment, with lighter

NOTE: STUDY THE OPERATOR'S MANUAL BEFORE OPERATING THIS MACHINE.

12574

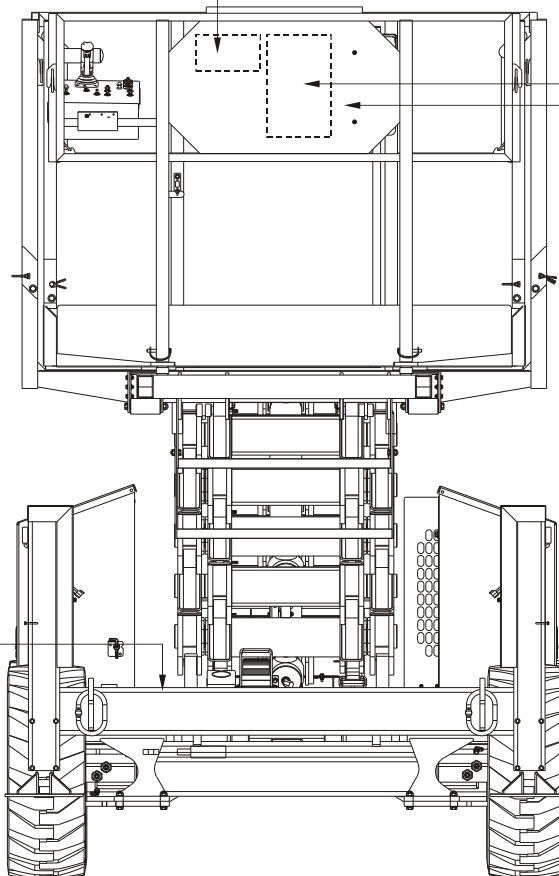

ALL DECALS ON REVERSE SIDE

On Top Of Chassis Member

←

EMERGENCY BLEED DOWN VALVE

1. Safety

REAR END OF SR

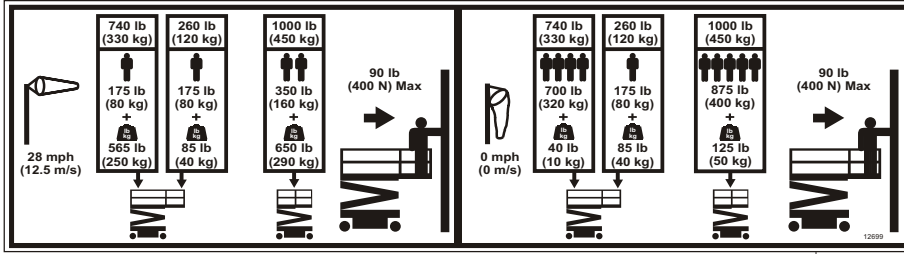

(LATER VERSION RATED LOAD DECAL)

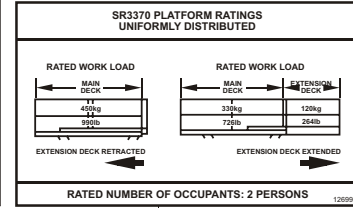

SR3370

⚠ DANGER

- THIS UNIT IS EQUIPPED WITH FOAM FILLED TIRES, WHEEL WEIGHT IS CRITICAL FOR UNIT STABILITY.
- REPLACE WITH FACTORY APPROVED FOAM FILLED TIRES ONLY.
- DO NOT ATTEMPT TO INFLATE.

⚠ DANGER

DO NOT ALTER OR DISABLE LIMIT SWITCHES, SAFETY SWITCHES, OR INTERLOCKS.

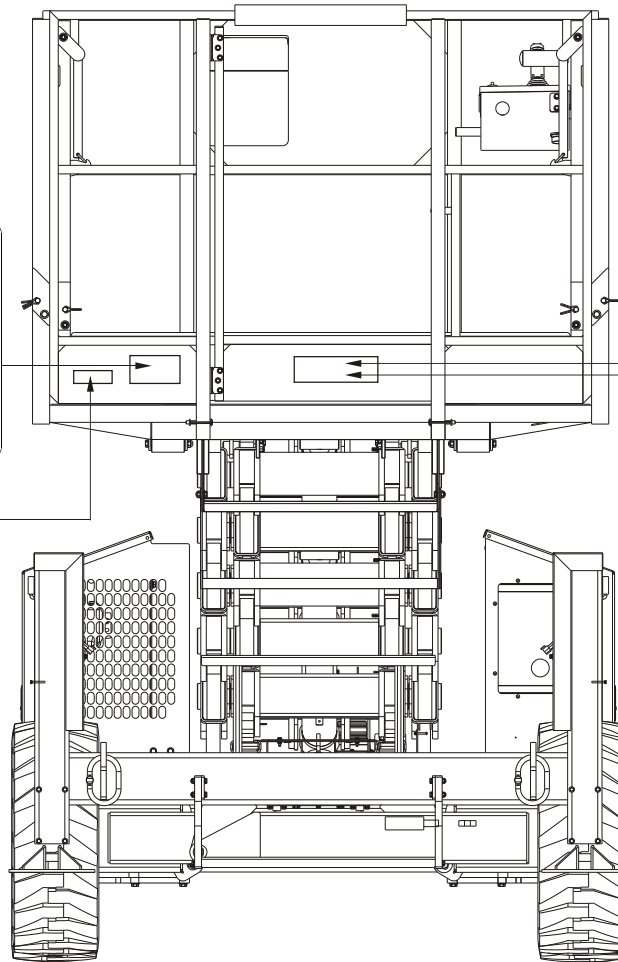

(LATER VERSION RATED LOAD DECAL)

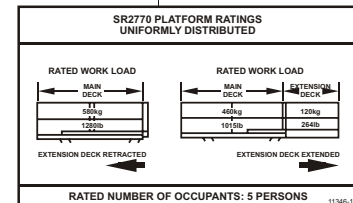
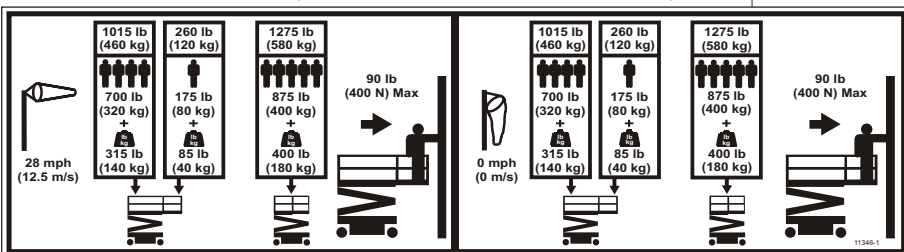

SR2770

■ Safety Device Information

For emergency operation controls and procedures see the Emergency Operation chapter 9, in this manual.

The devices listed in this chapter are safety devices.

They are on an SR to increase safety in the work place for both the operator and other people near the machine.

▲ WARNING

Do not by-pass, disable, modify, or ignore any of these devices. Check them carefully at the start of each work shift to see that they are in working order (see Daily Inspection & Maintenance chapter 7). If any is found to be defective, remove the SR from service immediately until a qualified service technician can make repairs.

■ Emergency Stop Switches

□ At platform control box

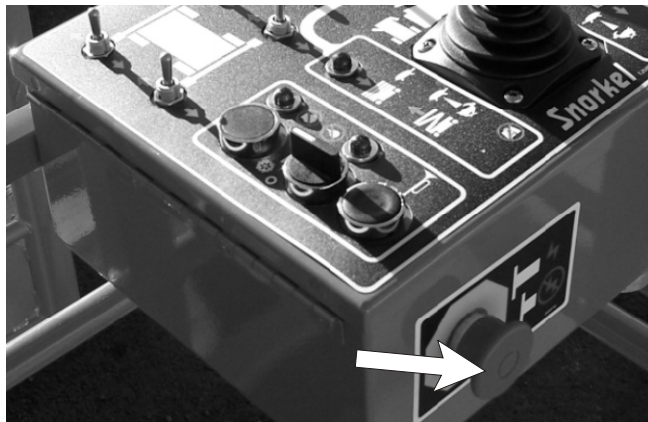

Figure 2.1 - Platform Control Box Emergency Stop Switch

Press the large red **EMERGENCY STOP** button in and the entire machine stops, the engine turns off, and nothing moves. This switch must be out (on) to control the SR from the platform (pull the switch and it will pop out).

□ At ground control box



Figure 2.2 - Ground Control Box Emergency Stop Switch

Press the red **EMERGENCY STOP** switch cover down, at any time, under any conditions, and the entire machine stops, the engine turns off, and nothing moves. the **EMERGENCY STOP** switch must be up for anything on the SR to work.

■ Alarms

There are two alarms on an SR. One is located in the platform control box, the other is located in the ground control box.

The alarms are connected in parallel, they both emit the same pattern of sound at the same time. The different alarm sound patterns are shown in the table immediately below and discussed below the table.

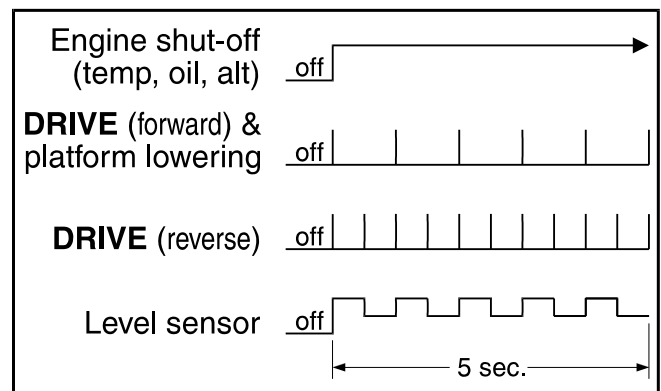

Figure 2.3 - Alarm Sound Patterns

The high-temperature, low oil-pressure, and alternator not-charging alarms are each a continuous tone.

2. Safety Devices

The DRIVE (forward) and the platform-lowering alarms beep at one beep per second. DRIVE (reverse) beeps at two beeps per second. The level sensor alarm is a high-low warbling sound.

Level sensor

The level sensor alarm warns the SR operator that the SR is not level. When you hear this alarm, immediately lower the platform completely down. When the platform is completely down, determine and correct the cause of the tilt before raising the platform again.

NOTE

While the alarm is sounding it is not possible to drive the SR nor raise the platform

Lowering

The lowering alarm warns people near an SR that the platform is coming down and the scissor arm assembly is closing.

High temperature

The high-temperature alarm warns you that the engine is overheating. When the alarm sounds you should immediately lower the platform completely down then turn the engine off until the condition that caused the overheating has been corrected. (See Automatic Shut-Offs & Circuit Breakers chapter 5 for more information.)

Low oil pressure

The low pressure alarm warns you that the engine oil pressure is near the lower limit for safe operation of the engine. When the alarm sounds you should immediately lower the platform completely down then turn the engine off until the condition that caused the low oil pressure has been corrected. (See Automatic Shut-Offs & Circuit Breakers chapter 5 for more information.)

Drive (reverse)

The DRIVE (reverse) alarm alerts people that the SR is traveling backward along the ground. This alarm beeps twice as fast as the DRIVE (forward) alarm.

Drive (forward)

The DRIVE (forward) alarm alerts people that the SR is traveling forward along the ground. This alarm beeps half as fast as the DRIVE (reverse) alarm.

■ Guardrails



Figure 2.4 - Guardrails

The guardrails help protect you from falling off the platform. Be sure the guardrails are properly installed and that the gate is in place.

■ Safety Prop



Figure 2.5 - Safety Prop

Always raise the safety prop then lower the scissor-arm assembly onto the safety prop before reaching into the scissor-arm assembly for any reason.

■ Swinging Gate

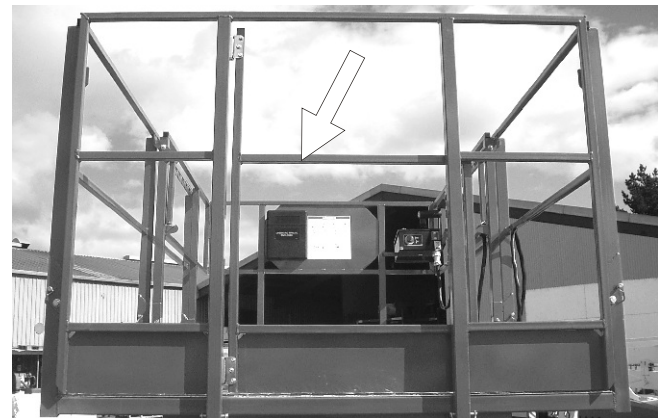

Figure 2.6 - Swinging Gate

The swinging gate should be closed at all times except when someone is entering or leaving the platform.

■ Safety Control

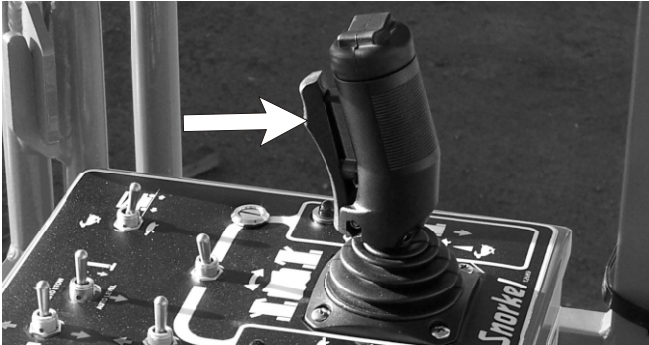

Figure 2.7 - Joystick Safety Control

The safety control must be squeezed and held to activate the joystick. The safety control prevents the joystick from moving the platform if something accidentally pushes the joystick. Do not disable the safety control in any way.

■ Bubble Level

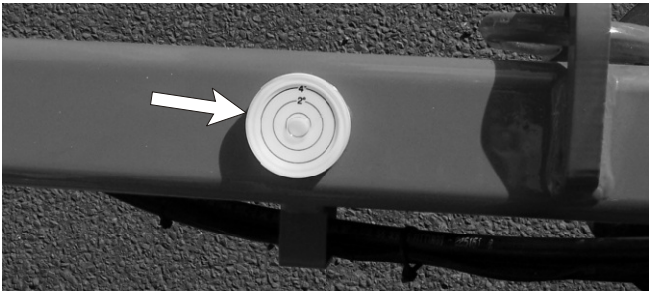

Figure 2.8 - Bubble Level

See the Gauges chapter 4 for a discussion of the bubble level.

■ Operator Horn



Figure 2.9 - Operator Horn

The operator horn is used primarily to get the attention of people on the ground when you are working aloft. For the horn to work the following switches, on the ground control box, must be set as indicated:

- MAIN POWER.....ON
- EMERGENCY STOP.....ON (up)
- SELECTOR.....PLATFORM

■ Stabilisers (Option)



Figure 2.10 - Stabilisers

The stabiliser controls are on the upper left side of the platform control box. The stabilisers are used to level the SR (for complete stabiliser operating procedures see the Operation chapter 8).

NOTE

The SR must be on a firm surface capable of withstanding all load forces imposed by the aerial platform in all operation conditions before the stabilisers are used.

■ RCD/ELCB AC Outlet (option)

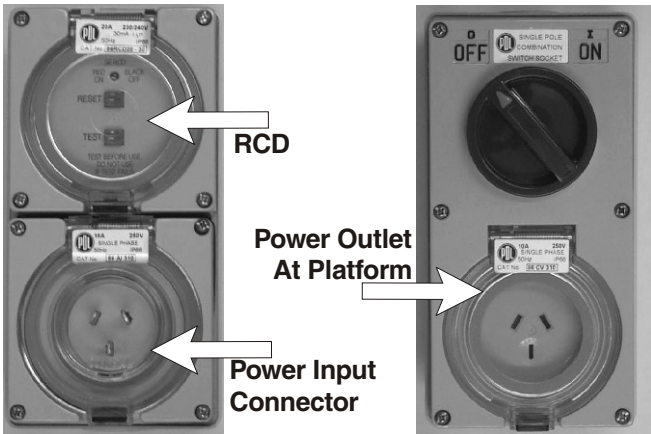

Figure 2.11 - RCD/ELCB AC Outlet

2. Safety Devices

The RCD (Residual Current Device) is located at the ground and will protect against short circuits to earth. When there is a short circuit the RCD will shut down the 230v AC power to the platform outlet. To reset the outlet disconnect the power tool lead from the platform box and reset the RCD at the ground. If the problem persists call a trained service technician.

■ Flashing Light (option)

The flashing light alerts people that the SR is present and that the SR is moving. The light flashes at about one flash per second any time the SR engine is running. There is no ON/OFF switch for the flashing light, it cannot be turned off while the SR is running.

■ Lanyard Anchor Points (option)

There are four anchors on the floor of the platform, one at the front of the roll-out deck, one at the back of the platform, and one on each side of the platform.

NOTE

These anchors are not for lifting or tying down the machine.

You should attach your fall protection to the anchors if work rules require it.

■ Specifications

The SR3370 / SR2770 series machines are scissor-supported elevating work platforms built to conform to the following standards.

OSHA Paragraph 1910.67 Title 29, C.F.R., Vehicle-Mounted Elevating and Rotating Work Platforms - Labour. OSHA Paragraph 1926.556 Title 29, C.F.R., Aerial Lifts - Construction. Australian Standard AS1418-10(Int) 2004 Elevating Work Platforms.

NOTE:

For further details regarding lubricants, maintenance schedules and service please refer to the Maintenance and Repair Parts Manual for this machine.

■ General Specifications, Standard Machine SR3370

SPECIFICATIONS	SR3370	
Nominal working height	12.12m	39' 2"
Roll out deck size	1200mm	48"
Drive speed (below 2.4m)	0 to 4.5kph	0 to 2.8mph
Drive speed (above 2.4m)	0 to 0.35kph	0 to 0.22mph
Safe working load - Main deck (Roll out deck not extended)	450kg	990lbs
Safe working load - Main deck Roll out deck extended - Roll out deck	330kg 120kg	726lbs 264lbs
Platform size	2.73 x 1.65m	8' 11" x 5' 5"
Stowed height	2.7m	8' 10"
Stowed height (hand rails folded down)	2.0m	6' 6"
Overall length	3.36m	11' 0"
Overall width	1.77m	5' 9"
Gradeability	35%	
Lift time	50 seconds	
Turning radius (inner)	2.38m	7' 8"
Turning radius (outer)	4.75m	15' 6"
Maximum wind speed (12.5m/s)	45km/h	28mph
Insulation rating	Nil	
Tyres - Poly filled loader lug	27" x 10.5" x 15"	
Overall weight	3620kg	7964lbs
Ground clearance	350mm	13.8"
Maximum sound level at platform	86db	

■ Recommended Hydraulic Oil

Shell Tellus 32 or Castrol AWS 32 or similar.

3. Specifications

■ General Specifications, Standard Machine SR2770

SPECIFICATIONS	SR2770	
Nominal working height	10.28m	33' 9"
Roll out deck size	1200mm	48"
Drive speed (below 2.4m)	0 to 4.5kph	0 to 2.8mph
Drive speed (above 2.4m)	0 to 0.9kph	0 to 0.6mph
Safe working load - Main deck (Roll out deck not extended)	580kg	1280lbs
Safe working load - Main deck Roll out deck extended - Roll out deck	460kg 120kg	1015lbs 265lbs
Platform size	2.73 x 1.65m	8' 11" x 5' 5"
Stowed height	2.5m	8' 2"
Stowed height (hand rails folded down)	1.7m	5' 8"
Overall length	3.36m	11' 0"
Overall width	1.7m	5' 8"
Gradeability	35%	
Lift time	26 seconds	
Turning radius (inner)	2.83m	9' 3"
Turning radius (outer)	4.6m	15' 1"
Maximum wind speed (12.5m/s)	45km/h	28mph
Insulation rating	Nil	
Tyres - Poly filled loader lug	27" x 10.5" x 15"	
Overall weight	2800kg	6272lbs
Ground clearance	350mm	13.8"
Maximum sound level at platform	86db	

■ Engine Data

Engine Make	Kubota		
Model	DF752		D902
Fuel	gasoline	LPG	Diesel
Fuel grade	Unleaded 85 octane (motor method) Do not use gasoline blended with methyl alcohol.	HD5 Gas Processors Association Standard 2140 Category: special duty propane	ASTM Grade 2-D S5000 Tier 4 Compliance: Low Sulpher ASTM Grade 2-D S500 Centane number >44 (For operating temp. Below 32°F (0°C) use “winterized” number 2-D.)
Coolant	50% water + 50% ethylene glycol		
Maximum temperature	110°C		
Oil Capacity	3.7L		
Oil grade	API: Quality better than CD		
Oil weight	See chart below		

■ Engine Oil Charts

□ DF752

Ambient temperature	Engine oil weight
Above 77°F (25°C)	SAE30 or 10W30
32°F to 77°F (0°C) to (25°C)	SAE20 or 10W30
0°F to 32°F (-17°C) to (0°C)	SAE10W or 10W30

□ D902

Ambient temperature	Engine oil weight
Above 77°F (25°C)	SAE30 or 10W30 10W40
32°F to 77°F (0°C) to (25°C)	SAE20 or 10W30 10W40
Below 32°F (0°C)	SAE10W or 10W30 10W40

3. Specifications

■ Machine Component Identification

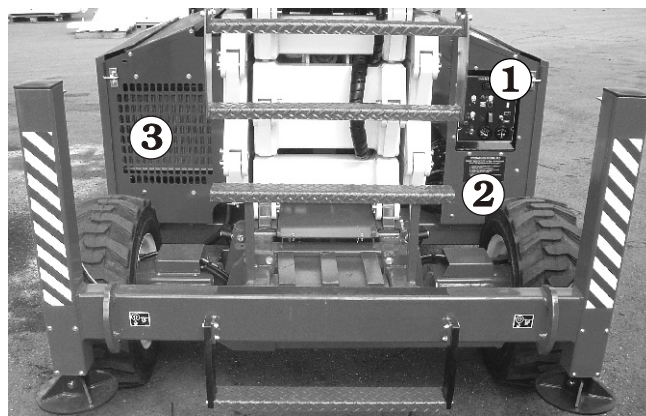
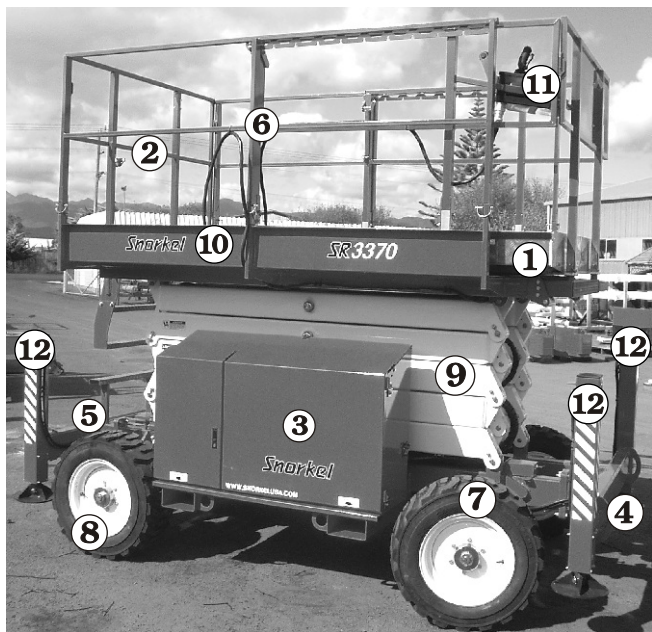

1. Base control panel
2. Serial number plate
3. Engine & fuel compartments

1. Extendable platform
2. Entry gate
3. Hydraulic compartment
4. Front end
5. Rear end
6. Guard rails
7. Steering (front) wheels
8. Rear Wheels
9. Scissor arms
10. Platform
11. Platform control box
12. Stabilisers / outriggers (Option)

■ Water



Figure 4.1 - Water Temperature Gauge

The water gauge is located on the ground control box. It shows the temperature of the water-anti-freeze mixture in the engine block. The typical operating-temperature range for Kubota engines is 180°F to 205°F (82°C to 96°C), both diesel and gasoline. (See the Automatic Shut-Offs & Circuit Breakers chapter 5 for more information.)

■ Amps



Figure 4.2 - Ammeter Gauge

The AMPS gauge shows the electric current from the alternator to the battery. When the engine is running, the needle in the AMPS gauge should not be to the left of 0. Under normal operating conditions, after the engine has been running for a few minutes, the AMPS gauge should read 0.

■ Engine Oil

Engine oil level is measured with a dipstick. Oil capacities given in the Specifications chapter 3 are approximate. True values will vary from machine to machine due to slight variations or modifications during production.

- The oil dipstick is the only way to accurately gauge if the engine oil level is correct.
- Engine oil level should always be between the lines on the dipstick - never above the top line or below the bottom line.

Gasoline

Diesel

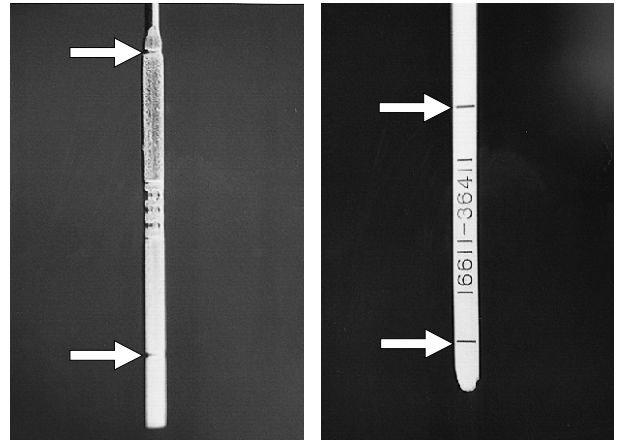

Figure 4.3 - Oil Dipstick Levels for Gasoline and Diesel Engines

■ Hydraulic Oil Level



Figure 4.4 - Hydraulic Oil Level

The hydraulic-oil level gauge is on the side of the hydraulic oil tank. It shows the actual level of oil inside the tank. Read it only when the platform is completely down. Otherwise, the lift cylinders become large reservoirs for hydraulic oil and the oil level in the tank will be low. The oil level should be within (0.25 inches, 6.4 mm) of the line.

4. Gauges

■ Hours



Figure 4.5 - Hour Gauge

The HOURS gauge is basically an electric clock. It accumulates time only when the engine is running. The HOURS gauge cannot be reset. An SR-qualified service technician uses it to tell when it is time for the periodic maintenance listed in the Maintenance Manual.

■ Fuel Level (option)

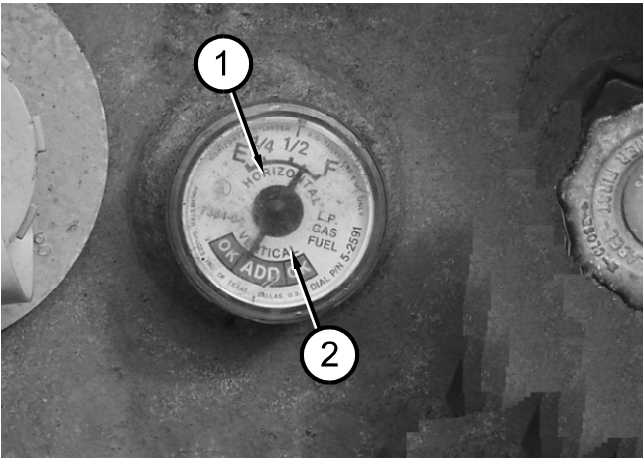

Figure 4.6 - Fuel Level Gauge

LPG tanks have two fuel gauges on top. One measures correctly when the tank is standing on end (VERTICAL) & the other measures correctly when the tank is laying down (HORIZONTAL) . Both read in fractions-of-a-full-tank. (see Figure 4.6).

NOTE:

LPG fuel installations are usually fitted post production and may vary from machine to machine. It is the operator's responsibility therefore, to be aware of how the system is installed on their individual machine and know which gauge, (horizontal or vertical) to read.

■ Bubble Level

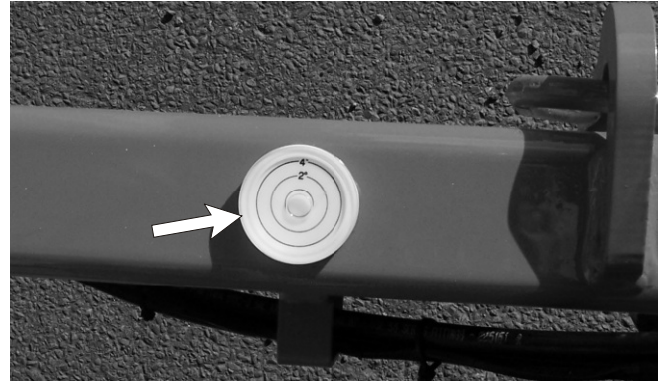

Figure 4.7 - Bubble Level

A bubble level is located on the platform side rail, below the platform control box. Watch the bubble level while you set the stabilisers manually. Lower the stabilisers, one at a time, just enough to center the bubble in the circle on top of the gauge. When the bubble is centered the platform is level and can safely be raised.

5. Automatic Shut-offs and Circuit Breakers

■ Automatic Shut-offs

□ Level sensor

When the level sensor alarm sounds, automatic interlocks make it impossible to drive the SR or raise the platform. For more complete information see the Level Sensor subsection of the Safety Devices 2 chapter.

□ Engine temperature

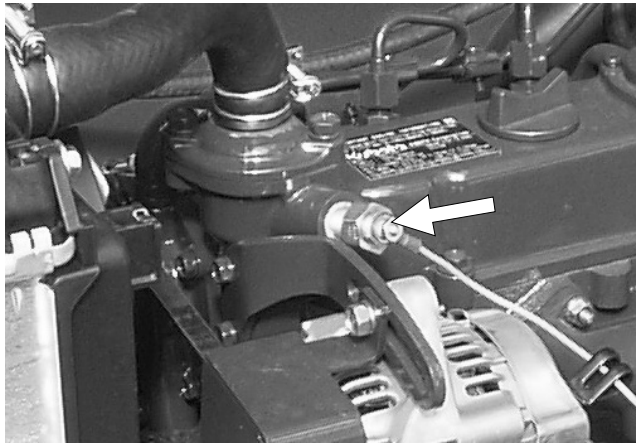

Figure 5.1 - Engine Temperature Sensor

There is a temperature sensor in the engine. It measures the temperature of the antifreeze-water mixture as the mixture leaves the top of the radiator and enters the top of the engine. If the temperature reaches 210(F (99(C) an alarm sounds. If the temperature continues to rise, the engine shuts off when the temperature reaches 230(F (110(C). The engine will not restart until the temperature drops below 210(F (99(C).

□ Engine oil pressure

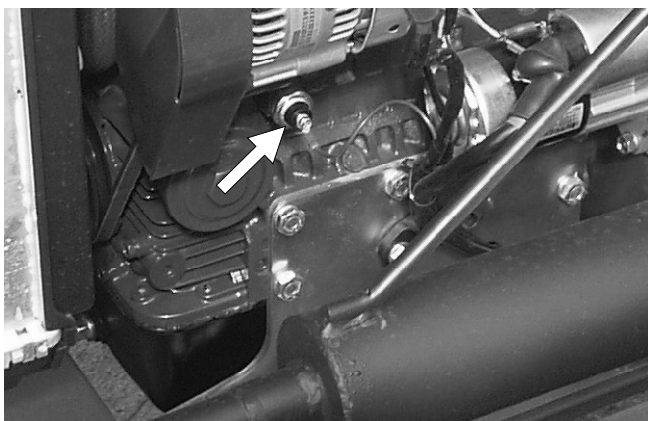

Figure 5.2 - Engine Oil Pressure Sensor

There is an oil pressure sensor in the engine. It measures the engine oil pressure at the oil filter. If the pressure falls below a safe operating value the

engine shuts off. The engine will restart with low pressure but it will only run a few seconds before it automatically shuts off again.

□ Platform height vs. drive speed

When the platform is over 1.7m (5 6") above the ground the drive speed is limited to its slowest speed and the engine revs are also automatically lowered.

□ Dynamic brakes

When you drive an SR down a slope, if the SR begins to coast (outrun the drive motors) the hydraulic system senses the coasting condition. The hydraulic drive motors then become hydraulic brakes and the SR is slowed. This action prevents SRs from speeding down grades.

□ Alternator not charging

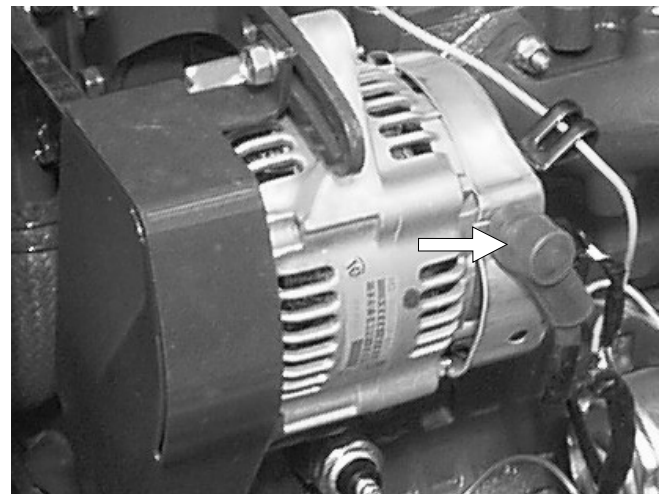

Figure 5.3 - Alternator Output Shutdown

When the fan belt breaks, or the alternator output falls below a safe level for other reasons, the engine automatically shuts off and an alarm sounds. As long as the SR battery is charged you can lower the platform, in the usual way, from the platform control box or the ground control box without the engine running.

□ Stabilisers

The SR cannot be driven unless the stabilisers are completely up. If you have just raised the stabilisers but the SR will not drive, double check to be sure all four stabilisers are completely up.

5. Automatic Shut-offs and Circuit Breakers

■ Circuit Breakers

□ Main breaker



Figure 5.4 - Main Circuit Breaker

There is only one circuit breaker, on a standard SR, that is accessible to the operator. Its purpose is to protect the electrical circuits from electrical overloads. When the circuit breaker trips (pops out) push it back in then attempt to use the SR.

If the circuit breaker trips a second time, take the SR out of service and refer the problem to a qualified trained service technician for repair.

□ RCD / ELCB outlet (option)

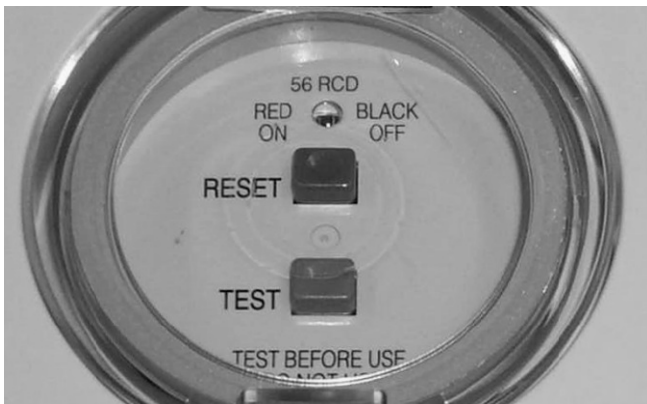

Figure 5.5 - RCD/ELCB Outlet

The RCD (Residual Current Device) is located at the ground and will protect against short circuits to earth. When there is a short circuit the RCD will shut down the 230v AC power to the platform outlet.

To reset the outlet disconnect the power tool lead from the platform box and reset the RCD at the ground.

If the problem persists call a trained service technician.

■ Controls

This chapter explains what each control does.

This chapter does not explain how to use the controls to produce useful work, refer to the Operation chapter 8 for that, after you have read this chapter.

For optional-equipment controls, see the Options chapter 11 .

See the Emergency Operation chapter 9 for the location of the emergency bleed down control and for correct emergency bleed down procedures.

The main operating functions of an SR can be controlled from the ground control box (1) or the platform control box (2).



Figure 6.1.1 - Control Box Location, Ground Position



Figure 6.1.2 - Control Box Location, Platform Position

■ Hydraulic Compartment

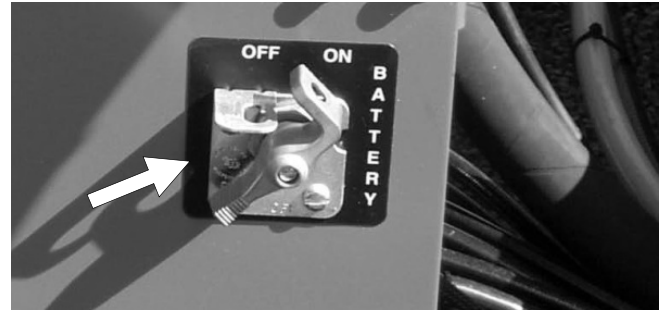

Figure 6.2 - Battery Switch

1. **Battery Switch:** This must be ON for the engine to start. When the battery switch is OFF the positive side of the SR battery is disconnected from the electrical system. Lock this switch OFF when the SR is left unattended.

■ Ground Control Box

Controls for operating an SR from the ground are located on the right side of the machine on the rear of the hydraulic compartment.

NOTE 1

The number of each control corresponds to Figure 6.3.

NOTE 2

Some switches and indicators are either not used, or may serve a different purpose depending on the configuration of your machine.

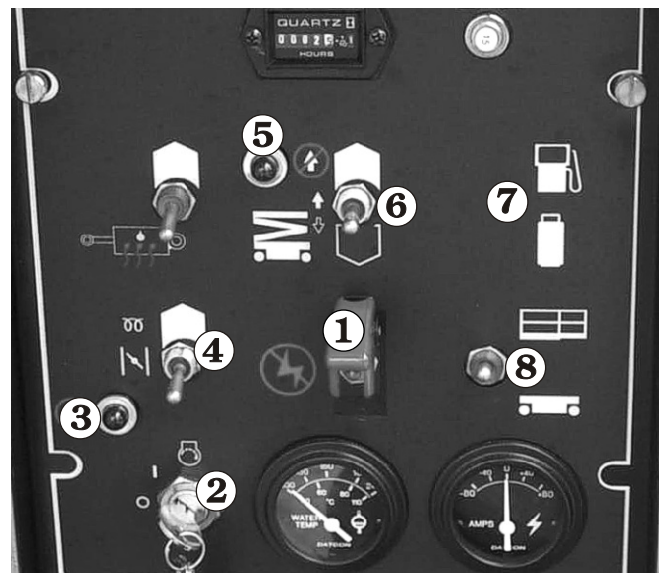

Figure 6.3 - Ground Control Box Controls

6. Controls

1. **Emergency Stop:** Press the red switch-cover down, at any time, under any conditions, and the entire machine stops - the engine turns off and nothing moves. This switch must be up for anything on the machine to work.
2. **Key Switch:** This switch works like an automobile ignition switch. Hold the key at the start symbol (extreme clockwise position) until the engine starts then release it to the on position (bar symbol). Turn the key to off (O) if the platform is to stay in one position for a long time. That will turn the engine off and save fuel.
3. **Choke Indicator Light:** (gasoline engines only): This light will be lit while you choke the engine (see CHOKE below).
3. **Glow-Plug Indicator Light:** (diesel engines only): This light will be on while the glow plugs are on. Wait, about 30 seconds for the light to go out before you try to start a diesel.
4. **Choke:** (gasoline engines only): Hold the choke switch up anytime you start a gasoline engine that is at ambient air temperature (a cold engine).
4. **Glow Plug:** (diesel engines only): This is a momentary contact switch. Press it up then release it just before you start a diesel engine that is at ambient air temperature (a cold engine). This action automatically causes glow plugs to come on for 30 seconds to warm the inside top of each cylinder, thus aiding combustion.
5. **Lift Indicator Light:** The platform can be raised only when this light is lit. When this light is not lit the platform will not rise because: the platform is not level, or the stabilisers are not properly set.
6. **Platform Lift/Lower:** Holding this switch up causes the platform to rise. Pushing this switch down causes the platform to lower.
7. **Fuel (option):** Before starting a dual-fuel engine set the FUEL switch to gasoline (up) or LP gas (down) depending on which you want to use. If you select LP gas, be sure to open the valve on top the LP gas tank.
8. **Ground/Platform Selector:** Must be down for the ground control box to work. Must be up for the platform control box to work.

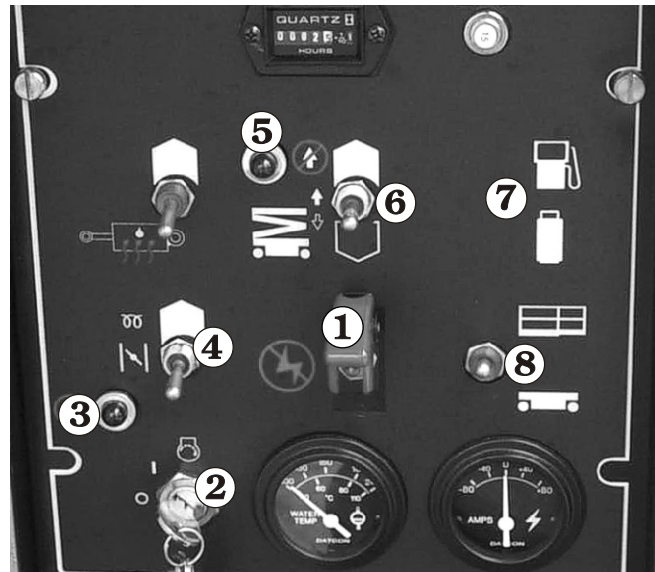

Figure 6.3 Ground Control Box Controls

■ Platform Control Box

Controls for operating an SR from the platform are located on the platform control box.

NOTE

The number of each control corresponds to Figure 6.4.

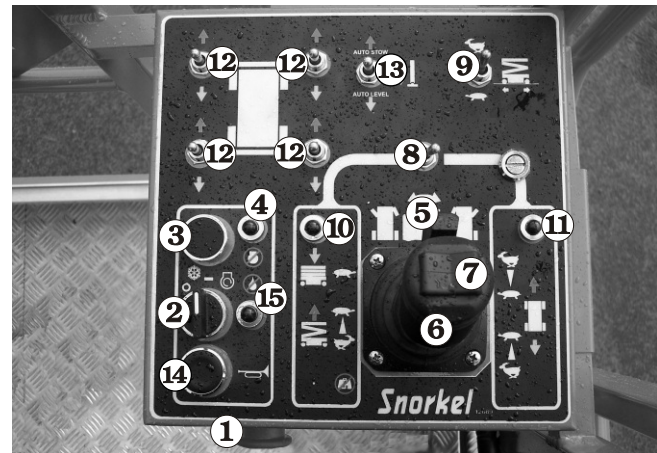

Figure 6.4 - Platform Control Box Controls

1. **Emergency Stop:** Press the red button in at any time, under any conditions, and the entire machine stops - the engine turns off and nothing moves. This switch must be out (on) to start and run the SR from the platform control box, pull the switch and it will pop out (on). Press the switch in (off) if the platform is to stay in one position for a long time. That will turn the engine off and save fuel.

NOTE

The EMERGENCY STOP switch on the ground control box overrides the one on the platform control box. If the one on the ground control box is off the SR will not start or run, it does not make any difference whether the one on the platform control box is on or off.

2. **Start:** Turn and hold the switch to the right to start the engine. As soon as the engine starts, release the switch.
3. **Choke:** (gasoline engines only): Press and hold the switch in anytime you start a gasoline engine that is at ambient air temperature (a cold engine).
3. **Glow-Plug:** (diesel engines only): This is a momentary contact switch. Press it up then release it just before you start a diesel engine that is at ambient air temperature (a cold engine). This action automatically causes glow plugs to come on for 30 seconds to warm the inside top of each cylinder, thus aiding combustion.
4. **Choke Indicator Light:** (gasoline engines only): This light will be lit while you choke the engine.
4. **Glow-Plug Indicator Light:** (diesel engines only): This light will be on while the glow plugs are on. Wait for the light to go out before you try to start a diesel.
5. **Safety Control:** The SAFETY CONTROL must be squeezed against the JOYSTICK CONTROLLER to activate the joystick controller. If the safety control is not squeezed the joystick controller is inoperative.
6. **Joystick Controller:** If the LIFT/DRIVE SELECTOR is set to the left (lift function), pulling the joystick controller backward causes the platform to rise, pushing the joystick controller forward causes the platform to lower. If the LIFT/DRIVE SELECTOR is set to the right (drive function), pushing the joystick controller forward causes the SR to move forward, pulling the joystick controller backward causes the SR to move backward. The further you push or pull the controller the faster the motion (except lowering-it occurs at one speed only).

NOTE

Squeeze the SAFETY CONTROL anytime you use the JOYSTICK CONTROLLER.

7. **Steering:** The rocker switch on top of the JOYSTICK CONTROLLER turns the front wheels left or right depending upon which side of the switch you press.

NOTE

The wheels do not return to straight ahead, after a turn, the way automobile wheels do. You must use the STEERING switch to straighten the wheels after a turn.

8. **Lift/Drive Selector:** When this switch is set to the left the JOYSTICK CONTROLLER becomes a lift/lower controller to raise or lower the platform. When this switch is set to the right the JOYSTICK CONTROLLER becomes a drive controller to drive the SR forward or backward. The SR will not drive and lift at the same time.
9. **Speed:** Set the switch to turtle (slow) when you are working in close quarters or if you are new to the machine. Setting the switch to rabbit (fast) doubles the top speed of the SR.
10. **Lift Indicator Light:** The platform can be raised only when this light is lit. When this light is not lit the platform will not rise because: the platform is not level, or the stabilisers are not properly set.
11. **Drive Indicator Light:** The platform can be driven when this light is lit. When it is not lit the platform will not drive because with the platform raised the base is not level or with the platform raised the axle switches are not set.
12. **Stabiliser Manual Switches:** Each switch corresponds to one of the stabilisers (if stabilisers are fitted). Pull a switch backward to lower a stabiliser, push it forward to raise the stabiliser.
13. **Auto Level / Stow Switch:** Select either auto level or auto stow, to raise or lower the stabilisers automatically (if stabilisers are fitted).
14. **Horn Switch:** Press this switch to operate the horn.
15. **Oil Pressure Warning Light:** This indicator light should go off when the engine is started. Stop the engine immediately if this light comes on when the engine is running.

7. Daily Inspection and Maintenance

At the start of each work day (or 8 hour shift), an SR qualified operator must perform the Daily Inspection and maintenance (or Pre-Operation Inspection as it is sometimes referred to), as listed in the table below.

The purpose of the Daily Inspection and Maintenance is to keep the SR in proper working condition and to detect signs of malfunction at the earliest possible time.

Set the Key Switch to OFF before you begin this inspection.

Defective parts and/or equipment malfunctions jeopardize the safety of the operator and other personnel, and can cause damage to the machine.

▲ DANGER

DO NOT operate an SR that is known to be damaged or malfunctioning.

Repair all equipment damage or malfunctions, before placing the SR into service

■ Daily Inspection and Maintenance Table

Item	Service Required
Fuel level	Visually inspect
Fuel filter (diesel engines only)	Visually inspect (condition)
Fuel leaks	Visually inspect (hoses and connections etc)
Engine oil	Check oil level (between dipstick lines)
Engine coolant	Check fluid level and radiator hoses
Radiator cap	Visually inspect installation)
Swinging gate	Visually inspect (installation, operation)
Wiring harnesses and connectors	Visually inspect (installation, operation)
Battery terminals	Visually inspect (no corrosion)
Battery fluid level	Visually inspect (covers plates)
Hydraulic tank cap	Visually inspect installation)
Hydraulic oil level	Check fluid level (at line on side of tank)
Hydraulic oil leaks	Visually inspect (hoses,tubes)
Tires and wheels	Visually inspect (condition)
Bolts and fasteners	Visually inspect (looseness)
Structural damage and welds	Visually inspect (welds, cracks, dents)
Guardrails	Visually inspect (condition)
Lanyard anchorages (option)	Visually inspect (condition)
Bubble level on platform	Visually inspect (condition)
Guides, rollers and slides	Visually inspect (condition)
Non slip tread grip	Visually inspect (condition)
Wrist support	Visually inspect (condition)
Operator manual	Visually inspect (that the manual is in the holder)
Placards, decals, and Operators Manual	Visually inspect (installation and condition)
START THE ENGINE FROM THE GROUND CONTROL BOX	
Charging system	Check condition (gauge)
Ground controls	Actuate and visually inspect for operation
Emergency lowering	Check operation (causes correct motion)
Platform controls	Actuate and visually inspect for operation
Flashing light	Visually check (operation)
RCD / ELCB (option)	Check operation
Air filter	Check condition
Safety prop	Check operation
Parking brakes	Check operation

7. Daily Inspection and Maintenance

The rest of this chapter shows how to perform the inspection and maintenance required for each item in the daily inspection and maintenance table.

■ Fuel Level



Figure 7.1 - Fuel Level

Remove the fuel tank cap. Visually Check to see that the gasoline or diesel tank is full. Replace the tank cap and tighten.

□ (LPG - Option)

To check the fuel read the fuel meter ④, on top (see Figure 7.2).

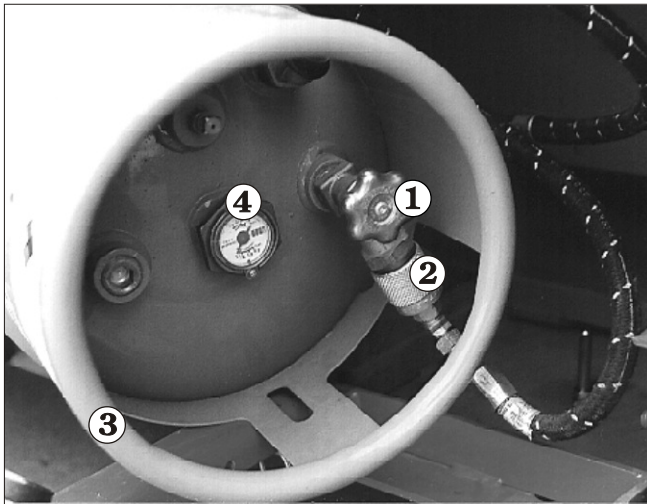

Figure 7.2 - LPG Fuel Tank Replacement

To replace an LPG tank: Close the valve ① (see Figure 7.2). Manually disconnect the fuel hose at the knurled ring ②. Manually lift the tank ③ out.

NOTE:

LPG fuel tank installations are usually fitted post production and may vary from machine to machine.

■ Fuel Filter (diesel engines only)

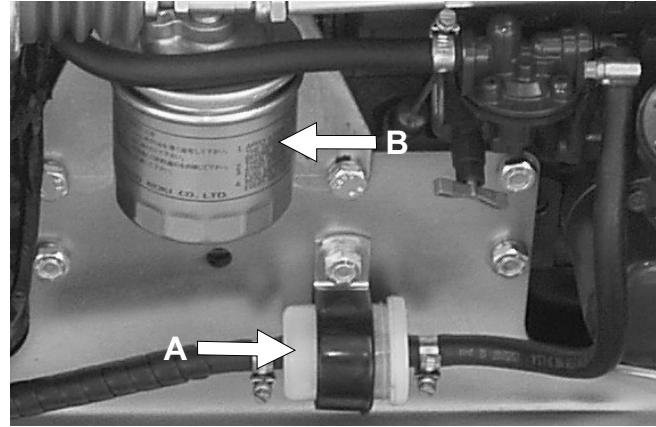

Figure 7.3 - Fuel Filter

The D902 has, in addition to the filter (B), a pre-filter unit (A). Visually check to see that the pre-filter is not full of contaminants and that there is no water in the bottom of the main filter (B).

■ Fuel Leaks

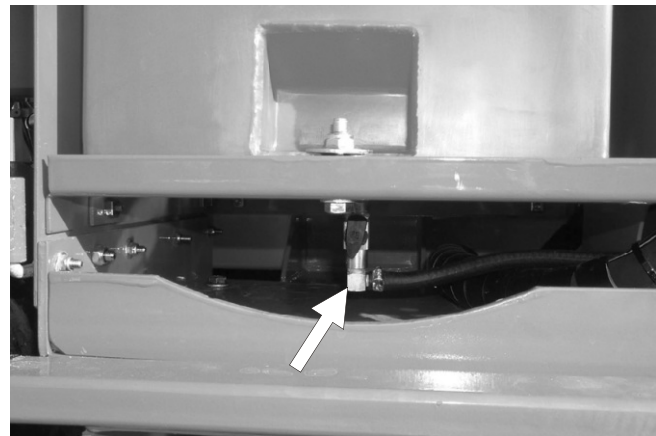

Figure 7.4 - Fuel Leaks at Tank

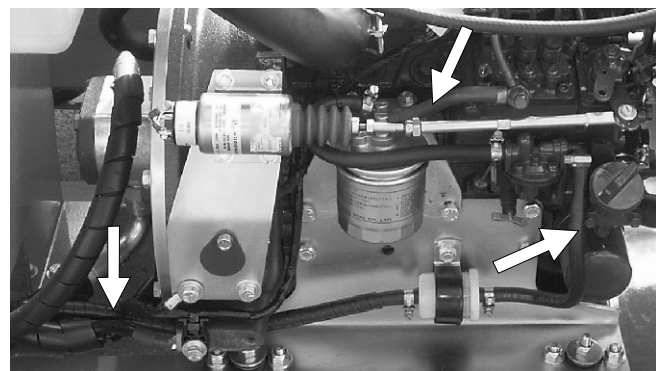

Figure 7.5 - Fuel Leaks in Hoses & Joints

Visually inspect the entire length of the fuel line, from the engine to the fuel tank, for leaks.

■ Engine Oil

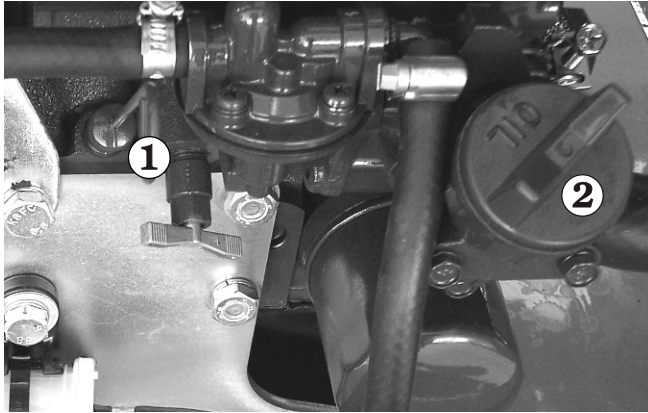

Figure 7.6 - Engine Oil Level

Keep the oil level between the marks on the dipstick **1** (see Figure 7.6).

The distance between the top and bottom dipstick marks corresponds to about 1 qt. (one liter). Add oil, if needed at the cap **2** (see Figure 7.6), there is an alternative filler cap on top of the engine.

See the Specifications chapter for the correct engine oil grade and weight.

■ Engine Coolant

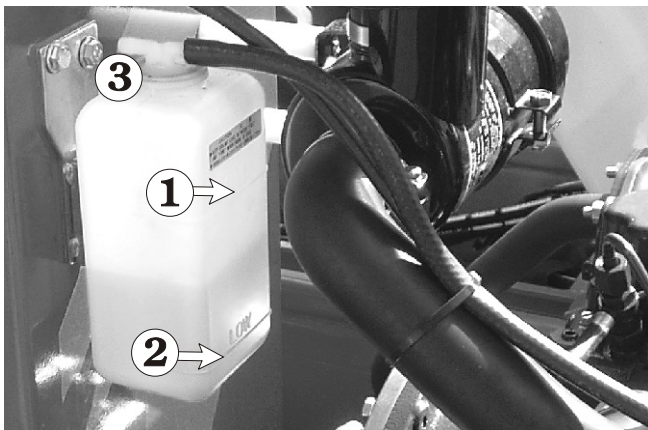

Figure 7.7 - Engine Coolant Level

The Kubota engine is liquid cooled. The coolant should be between the FULL level **1** and the LOW level **2** (see Figure 7.7).

The coolant is half water and half ethylene glycol.

To add coolant:

Turn the engine OFF at the ground control box KEY SWITCH. Remove the cap **3** (see Figure 7.7) from the coolant reservoir. Add coolant and replace cap.

■ Radiator Cap



Figure 7.8 - Radiator Cap

Visually check to see that the cap is in place and tight.

■ Swinging Gate



Figure 7.9 - Swinging Gate

Inspect the gate to see that it swings freely, latches securely, and is not deformed in any way.

■ Wiring Harnesses and Connectors

Inspect all the wiring harnesses, on the machine, for loose connections, broken wires, and frayed insulation.

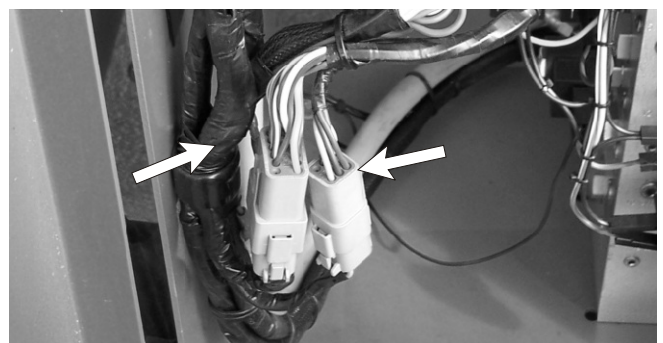

Figure 7.10 - Wiring Harnesses and Connectors

7. Daily Inspection and Maintenance



Figure 7.11 - Wiring Harness in the Scissor Stack

Pay particular attention to the wiring harnesses that are attached to the scissor stack. Note that the wire harness runs with the main hose bundle.

■ Battery Terminals



Figure 7.12 - Battery Terminals

Battery terminals should be clean and free of corrosion and the battery leads firmly attached.

□ Battery Fluid Level

▲ DANGER

Batteries emit hydrogen and oxygen, elements that can combine explosively. Death or serious injury can result from a chemical explosion.

DO NOT smoke or permit open flames or sparks when checking batteries.

Note

Units manufactured in New Zealand are typically fitted with a "maintenance free" battery.

If your unit is not fitted with such a battery you will need to do the following.

Remove the caps from the battery and visually check to see that the battery fluid is 1/4 (6 mm) below the bottom of the filler neck inside each hole

■ Hydraulic Oil Tank

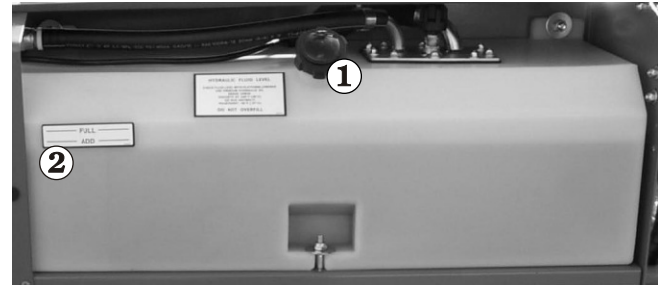

Figure 7.13 - Hydraulic Oil Tank

□ Hydraulic tank cap

Check to see that the cap ① is in place and is tight (see Figure 7.13).

□ Hydraulic oil level

To check the hydraulic oil level:

Completely lower the platform. The hydraulic oil level should be at the full level according to the gauge ② (see Figure 7.13). If necessary, add hydraulic oil at the Hydraulic oil tank cap. See the Specifications chapter for type and grade of hydraulic oil.

■ Hydraulic Oil Leaks

▲ DANGER

Leaking hydraulic oil can cause burns, fires, falls (slipping), cuts, and puncture wounds (if under high pressure). Do not tolerate hydraulic oil leaks. They are dangerous.

Do not search for leaks with your hand, use a piece of cardboard or wood. Hydraulic oil leaks are easily visible and can show up anywhere. Visually inspect the entire machine for hydraulic oil. Check the ground under the machine for leaked oil.

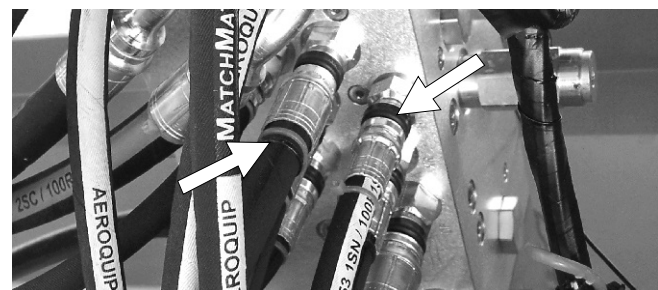

Figure 7.14 - Check Fittings at Valve

7. Daily Inspection and Maintenance

Check all fittings and hoses for leaks. Inspect hoses for signs of damage from chaffing or rubbing against protrusions on the chassis or scissor stack.



Figure 7.15 - Check Hydraulic Cylinders

Pay particular attention to the cylinders, check to see that there is no oil leaking from the seal, also check all hoses that run to the cylinders.

Have a qualified trained maintenance person repair all hydraulic fluid leaks before you operate an SR.

■ Tires and Wheels

SR tires are foam filled. Punctures of the type caused by bolts, screws, or nails are not a problem.

Look for large holes or long cuts completely through the tire body: holes or cuts where foam is being forced or eroded out of the tire.

Also look for large imbedded objects, such as angle iron, that can rip a tire body open under some conditions.

■ Bolts and Fasteners

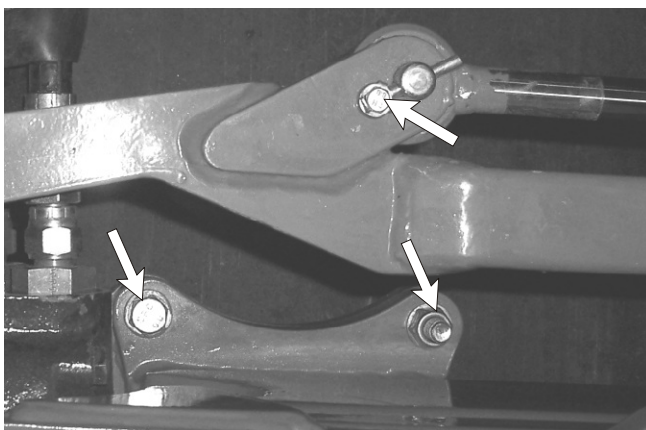

Figure 7.16 - Bolts and Fasteners

Visually inspect all fasteners to see that none are missing or obviously loose.

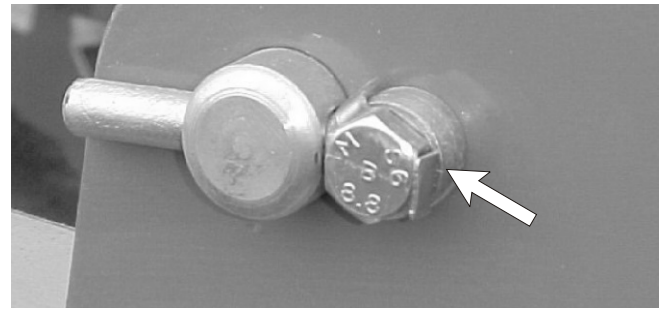

Figure 7.17 - Critical Pin Retainer Bolts

Critical pin retainer bolts have lock tab washers fitted, they should all be present and not damaged in any way.

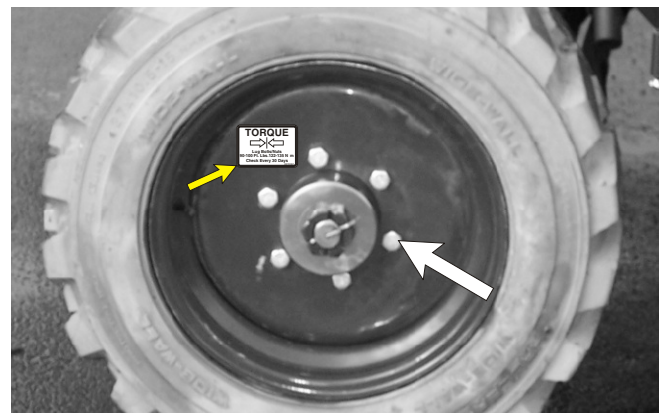

Figure 7.18 - Wheel Nuts

Pay particular attention to all of the wheel nuts. None should be visibly loose, missing, or deformed.

A decal is attached to each wheel rim giving the correct torque settings for the wheel nuts, see yellow arrow.

▲ IMPORTANT

The correct torque setting for the SR3370 / SR2770 wheel nuts is 90 - 100 lb ft or 122 - 135 Nm. Do not tighten beyond these settings.

▲ CAUTION

Do not over tighten wheel nuts. Over tightened wheel nuts can damage or deform the wheel rim. This could lead to stability problems.

7. Daily Inspection and Maintenance

■ Structural Damage & Welds



Figure 7.19 - Structural Damage and Welds

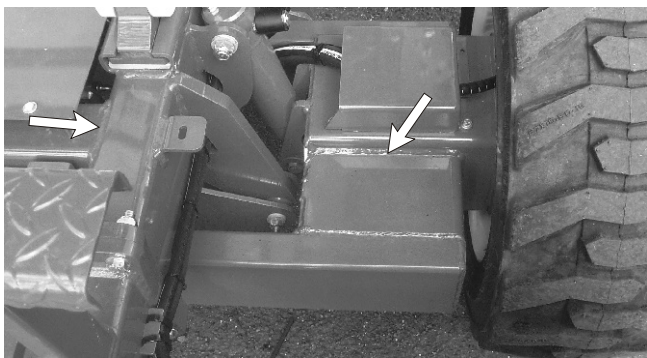

Figure 7.20 - Structural Damage and Welds

Visually inspect all welds for cracks, all structural members for deformity, and all sheet metal for dents that could interfere with machine operation.

■ Guardrails



Figure 7.21 - Guardrails

Pay particular attention to the guardrails. Make sure the guardrails are properly installed, that all the fasteners are in place, and that the swinging gate is in place and works properly.

■ Bubble Level

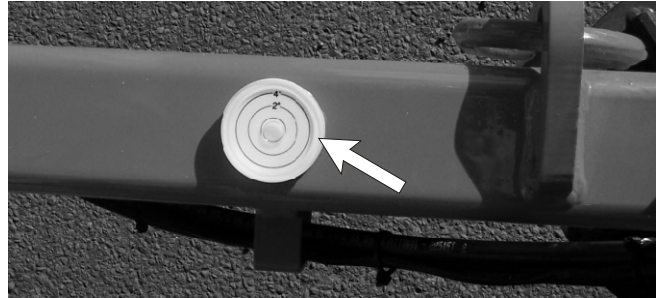

Figure 7.22 - Bubble Level

Visually check to see that the bubble level is not damaged, that it is full of fluid, that the bubble does not exceed the diameter of the center black circle, and the surface on which the bubble level is mounted is not deformed or bent out of level.

■ Guides, rollers, and slides

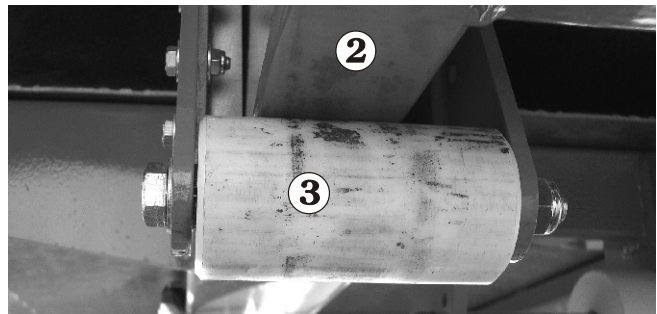
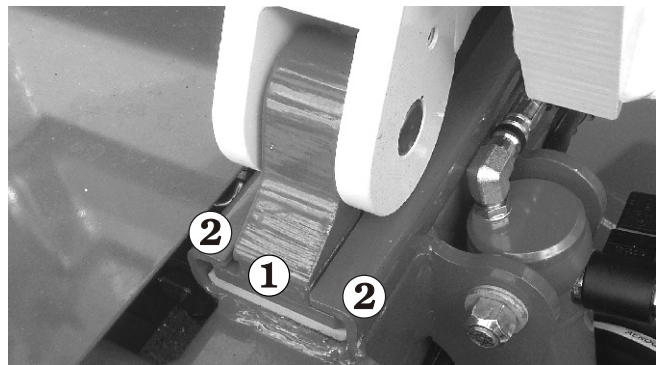

Figure 7.23 - Guides, Rollers and Slides

Visually check slides ① and rollers ③ for wear or damage. Be sure that the guides ② are free of debris and allow the slides and rollers to move smoothly.

■ Charging System



Figure 7.24 - Ammeter Gauge

With the engine idling, the needle in the AMPS gauge should not be to the left of 0" (left of 0" is discharging).

NOTE

Leave the engine running for the next step

■ Ground Controls



Figure 7.26 - Ground Controls

Check the Platform Lift/Lower switch **1** (see Figure 7.26) to see that it is functioning properly by holding the switch up to rise platform and pushing the switch down to lower the platform.

Pay particular attention to the Emergency Stop switch **2** (see Figure 7.26) to see that it turns the SR engine off when struck.

■ Flashing Light

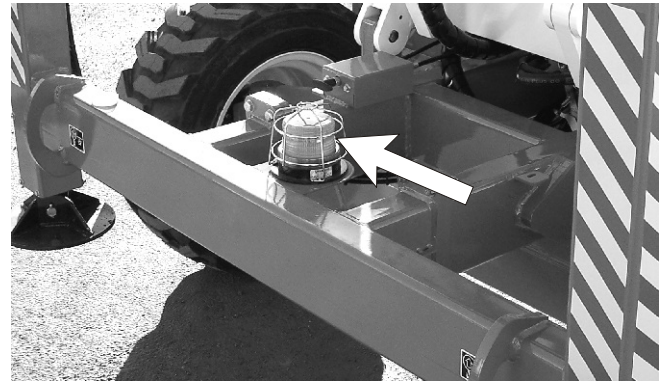

Figure 7.27 - Flashing Light

Check to see that the light flashes approximately once a second when the SR engine is running.

■ Platform Controls

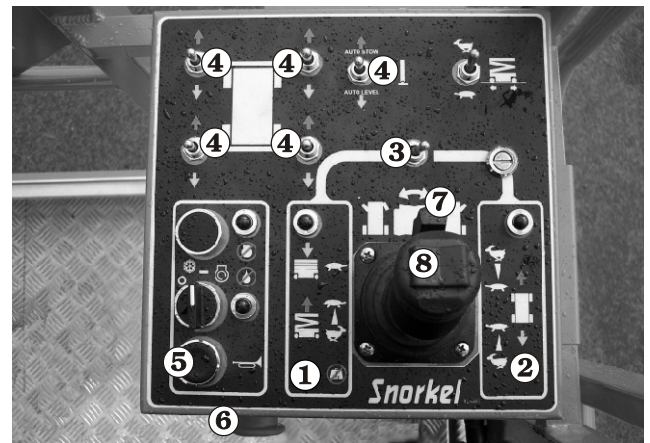

Figure 7.28 - Platform Controls

Check all of the lift , drive **2**, steer **3**, and stabiliser **4** functions from the platform control box to see that they cause the SR to move the way it should (see Figure 7.28). (for correct operating procedures see the Operation chapter).

Listen for the lowering alarm while the platform is going down. Listen for the motion alarm while the SR is being driven forward. Listen for the back-up alarm while the SR is backing up.

Press the operator horn **5** (see Figure 7.28) to see that it works.

Pay particular attention to the **Emergency Stop** switch **6** to see that it turns the engine off when struck (see Figure 7.28).

Pay particular attention to the **Safety Control** **7** to see that it deactivates the **Joystick Controller** **8** when the safety control **7** is released (see Figure 7.28).

7. Daily Inspection and Maintenance

■ Emergency Lowering

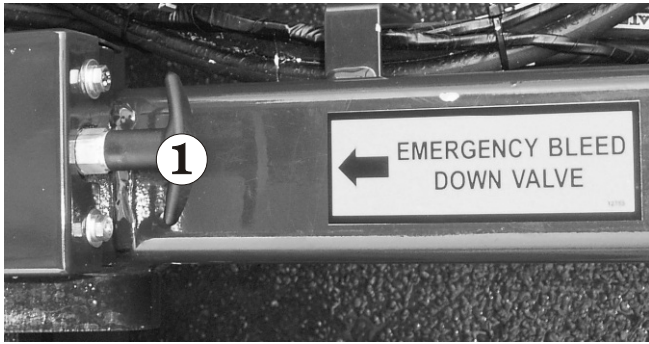

Figure 7.29 - Emergency Lowering

To check the emergency lowering: Raise the platform and turn the engine OFF at the ground control box KEY SWITCH.

Operate the emergency lower by pulling on the cable ❶ (see Figure 7.29) located at the front of the chassis. When the platform is fully lowered release the cable.

■ RCD / ELCB (Option)

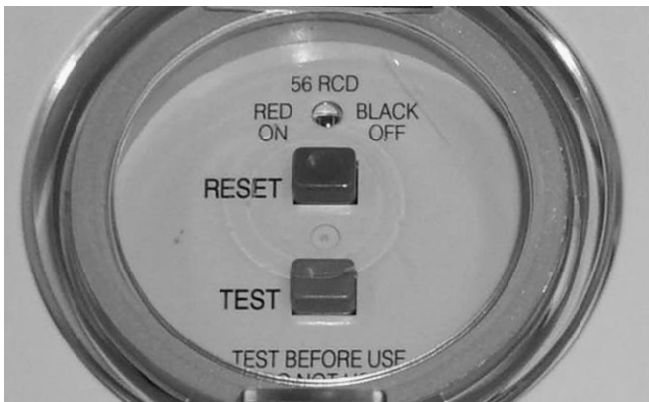

Figure 7.30 - RCD / ELCB

The RCD (Residual Current Device) is located at the ground and will protect against short circuits to earth. When there is a short circuit the RCD will shut down the 230v AC power to the platform outlet.

To reset the outlet disconnect the power tool lead from the platform box and reset the RCD at the ground.

If the problem persists call a trained service technician.

■ Safety prop



Figure 7.31 - Safety Prop

Inspect the safety prop(s) to see that it is present and moves freely.

■ Lanyard Anchorages (Option)

Check all four lanyard anchorages on the floor of the platform to see that they are present, not deformed, that they move freely, and that they are securely attached to the platform.

■ Non-Slip Tread Grip

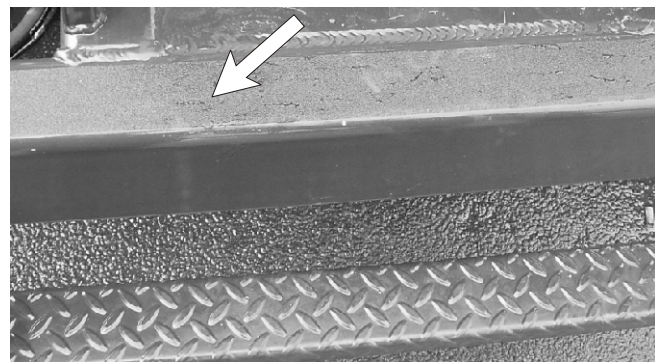

Figure 7.32 - Non-Slip Grip Strip

Check that the non-slip protective strip is in place and in good condition

■ Wrist Support

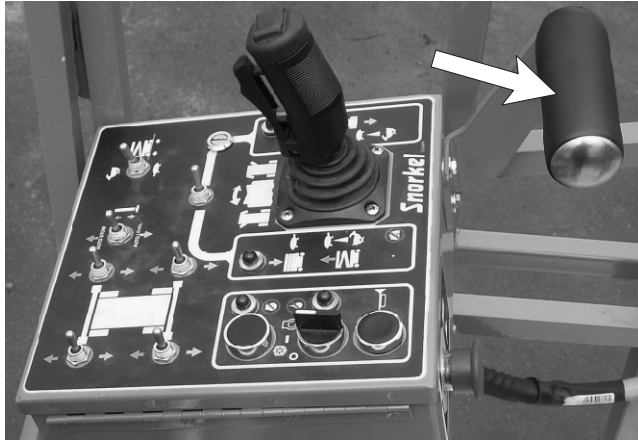

Figure 7.33 - Wrist Support

Check the condition of the rubber on the upper control box wrist support. Replace it if it is worn or damaged.

■ Operator Manual



Figure 7.34 - Operator Manual Holder

Check that the operation manual is in the holder.

7. Daily Inspection and Maintenance

■ Placards and Decals

Look to see that all placards and decals are in place and legible. Replace any missing or illegible placards or decals before placing the SR into service for the daily work shift.

Decal and placard kits for the SR are available from Snorkel dealers.

□ Standard placards and decals

- See page 7 - 11 for the following items:

No	Part No	Description	Req
1	1843	Decal - Warning, N.Z. only	1
	9428	Decal - Electrical hazard, Australia only	1
2	9208	Decal - Water	1
3	96924-9	Decal - Warning stripes yellow/black	4m
4	0070901E	Decal - Serial number	1
5	9751	Decal - N.Z. made	1
6	12671	Decal - SR3370	2
	11345-1	Decal - SR2770	2
7	12699	Decal - Rated load, SR3370	1
	11346-1	Decal - Rated load, SR2770	1
8	0073298	Decal - Foam tyres	1
9	451986	Decal - Interlocks	2
10	476706	Decal - Explosive fumes	2
11	12574	Decal - Danger with alarm	1
12	569295	Decal - Snorkel logo	5
13	560240	Decal - Lower control box	1
14	12689	Decal - Upper control box	1
15	560272	Decal - Emergency stop upper box	1
16	605726	Decal - Diesel fuel	1
17	12753	Decal - Emergency bleed down	1
18	12814	Decal - Hydraulic fluid	1
19	58365-6	Decal - Safety prop	1
20	9223-3	Decal - Chevron	4
21	300699	Decal - Operators checklist	1
22	0323897	Decal - Must not operate	1
23	621486	Decal - Forklift	4
24	302950	Decal - Hydraulic oil level	1

No	Part No	Description	Req
25	300700	Decal - Shearing hazard	1
26	13370 Rev B	Decal - Emergency operation, emergency lowering & emergency pushing	1
27	0083427	Decal - Lifting/tie down	4
28	12815-4	Decal - Hydraulic circuit, SR	1
29	12815-2	Decal - Electrical circuit, SR	1
30	562426	Decal - Operators manual enclosed	1
31	0372061	Decal - Torque wheel nuts	4
32	13182	Decal - www.snorkellift.com	2

7. Daily Inspection and Maintenance

□ Inspection drawing

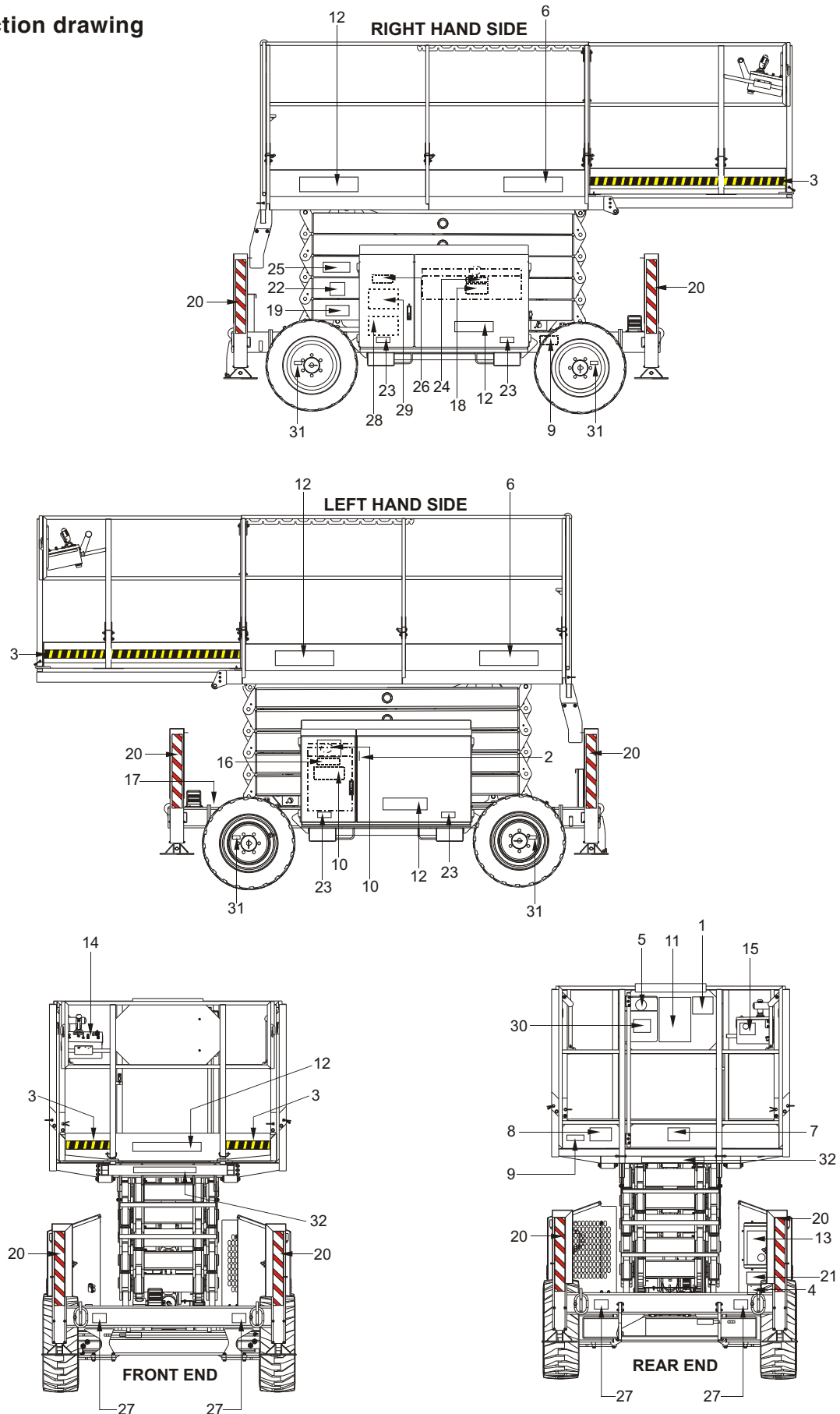

■ Operating Procedures

This chapter explains how to start and run an SR that has either a gasoline or diesel engine. Starting a gasoline engine that is set up to burn LP-only or dual-fuel is also discussed in this chapter. Read and understand all the previous chapters before you begin to operate an SR

■ Control Stations

An SR can be started and operated from the ground control box or from the platform control box.

▲ IMPORTANT

The ground control box can override the platform control box at any time. If a person operating the machine from the platform becomes incapacitated, a person on the ground can always take over machine control.

▲ DANGER

The SR is not Electrically insulated.

Death or Serious Injury to operating personnel, can occur if the machine should come into contact with energized electrical wires during operation.

DO NOT attempt to operate the SR ground controls if the platform, scissor assembly or any other conducting part of an SR is in contact with energized electrical wires or if there is an immediate danger of such contact.

NOTE

See the *Electrical Hazard* section, in this manual for a complete explanation of the hazards concerning electricity.

■ Emergency Stopping

To stop an SR, push either Emergency Stop switch, at any time on either the ground control box or the platform control box and the entire machine stops and nothing moves.



Figure 8.1 - Emergency Stop Switch at Ground Control Box

Ground control box Emergency Stop switch location.

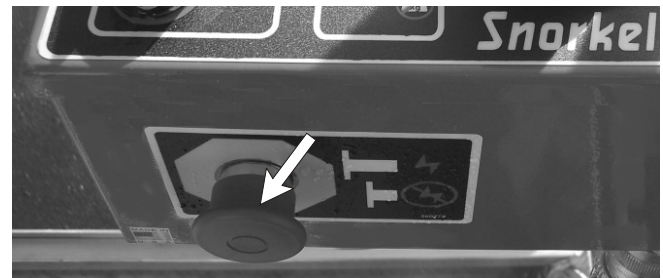

Figure 8.2 - Emergency Stop Switch at Platform Control Box

Platform control box Emergency Stop switch location.

NOTE

For a complete discussion of the Emergency Stop switches, see , Controls chapter , and Emergency Operation chapter 1, in this manual.

■ Operation Considerations

To use this chapter, first decide whether you will be starting and operating the SR from the ground control box or the platform control box.

Begin at the section entitled Operating From The Ground control Box if you intend to start and run the SR from the ground control box.

Begin at the section entitled Operating From The Platform Control Box if you intend to start and run the SR from the platform.

8. Operation

■ Fuel type

After you have made the ground control / platform control decision you need to know whether the SR has a gasoline or diesel engine. If it has a gasoline engine you further need to know whether it is set up to burn LP-only, or dual-fuel (LP or gasoline). If it is set up to burn dual-fuel you have to decide whether to burn gasoline or LP. The simplest way to tell what kind of engine set up you have is to look in the fuel compartment on the left side of the SR open both fuel compartment doors.

- If the only fuel source you see there is a tank labeled GASOLINE FUEL, the SR has a gasoline engine set up to burn gasoline.
- If the only fuel source you see is a tank labeled DIESEL FUEL, the SR has a diesel engine.
- If the only fuel source you see is one or more LP tanks, the SR has a special gasoline engine set up to burn LP-only.
- If you see a GASOLINE FUEL tank and one or more LP tanks, the SR has a special gasoline engine set up to burn either gasoline or LP.

Once you have determined the type of engine installed and the type of fuel you will burn you should go to the corresponding subsection that explains how to start that type engine. Read the Table Of Contents at the front of this manual to see how the different sections and subsections of this chapter are arranged.

■ Operating From The Ground Control Box

Before you begin to operate the SR from the ground control box, a qualified operator must perform the Daily Inspection and Maintenance as described in chapter 7, of this manual

→ Starting a gasoline, LP-only, or dual-fuel engine

To start a gasoline, LP-only, or dual-fuel (LP & gasoline) engine from the ground control box do the following:

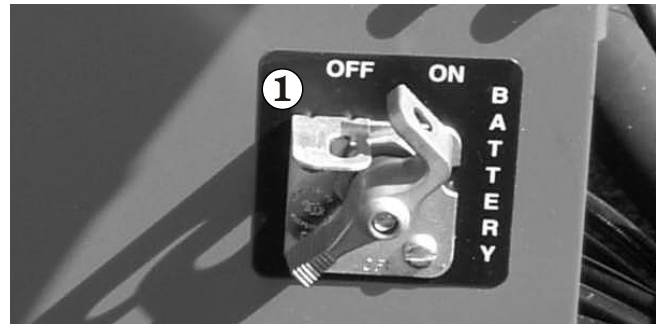

Figure 8.3

1. Set the **Battery** switch ① (see Figure 8.3) to on.



Figure 8.4

2. Set the **Emergency Stop** switch ② to on (up).
3. Set the **Ground/Platform Selector** switch ③ to ground (down) (see Figure 8.4).

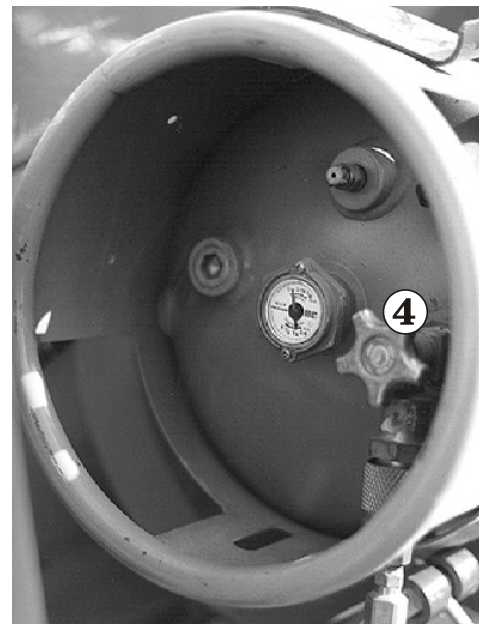

Figure 8.5

- For **LP operation**:
Completely open the valve **4** (see Figure 8.5) on top of the LP tank (unscrew counterclockwise until it stops).



Figure 8.6

- For a **dual-fuel engine**:
Set the **Fuel** switch **9** to LP fuel **5** or gasoline fuel **6**, depending on which you want to use (see Figure 8.6).
- If the engine is cold, press and hold the **Choke** switch **7** (see Figure 8.6) during the next step.
- Turn the key **8** to start and hold it there until the engine starts or for 20 seconds, whichever comes first. When the engine starts, release both the key **8** and the choke switch **7** (see Figure 8.6)

▲ CAUTION

If the engine does not start in 20 seconds, turn the key **8** to off and release the Choke switch **7** then wait 60 seconds before trying to start the engine again.

→ Starting a diesel engine

To start a diesel engine from the ground control box do the following:

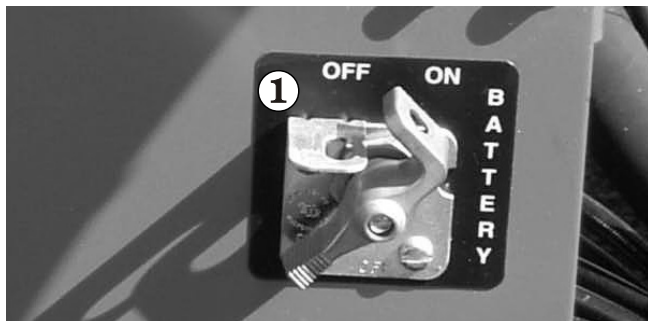

Figure 8.7

- Set the **Battery** switch **1** to on (see Figure 8.7).



Figure 8.8

- Set the **Emergency Stop** switch **2** to on (up) (see Figure 8.8).
- Set the **Ground/Platform Selector** switch **3** to ground (see Figure 8.8).
- Turn the key **4** to on do not turn the key **4** to start (see Figure 8.8).
- If the engine is at ambient temperature, momentarily press the **Glow-Plug** switch **5**. This action will automatically turn the glow-plugs, in the engine, on for 10 seconds. A light **6** will automatically come on to indicate that the glow-plugs are on (see Figure 8.8).
- When the light **6** goes out, turn the key **4** to start and hold it there until the engine starts or for 20 seconds, whichever comes first. When the engine starts, release the key **4** (see Figure 8.8).

▲ CAUTION

If the engine does not start in 20 seconds, turn the key **4** to off then wait 60 seconds before trying to start the engine again with the Glow-Plug switch **5** and key **6**.

■ Raising the platform

To raise the platform from the ground control box, do the following:

- The engine must be running. If not, start it from the ground control box as described above.

8. Operation



Figure 8.9

2. To raise the platform, press and hold the Platform Lift/Lower switch **1** up (see Figure 8.9).

NOTE

If the indicator light **2** is not lit, the platform will not rise because: the chassis is not level, the stabilisers (if present) are not properly set. Correct the problem then continue.

3. To lower the platform, press and hold the Platform Lift/Lower switch **1** down (see Figure 8.9).

■ Operating From The Platform Control Box

Before you begin to operate the SR from the platform control box, a qualified operator must perform the Daily Inspection and Maintenance as described in chapter , of this manual

→ Starting a gasoline, LP-only, or dual-fuel engine

To start a gasoline, LP-only, or dual-fuel (LP & gasoline) engine from the platform control box do the following:



Figure 8.10

1. Set the Battery switch **1** to on (see Figure 8.10).



Figure 8.11

2. Set the Emergency Stop switch **2** to on (up) (see Figure 8.11).
3. Set the Ground/Platform Selector switch **3** to platform (up) (see Figure 8.11).

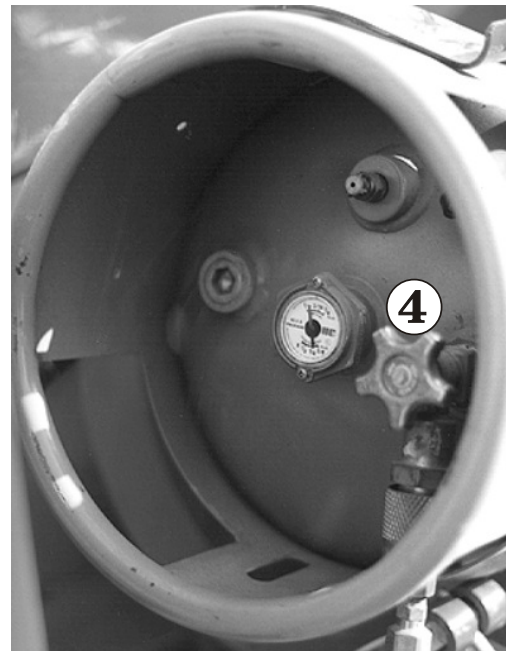

Figure 8.12

4. For LP operation: Completely open the valve **4** (see Figure 8.12) on top of the LP tank (unscrew counterclockwise until it stops).



Figure 8.13

5. **For a dual-fuel engine:**
Set the FUEL switch 5 to gasoline 6 or LP gas 7, depending on which you want to use (see Figure 8.13).
6. Enter the platform and close the gate.

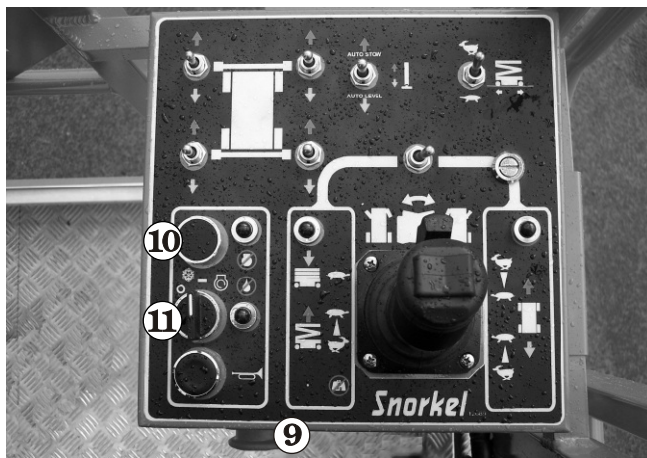

Figure 8.14

7. Turn the **Emergency Stop** switch 9 clockwise and it will pop out (on) (see Figure 8.14).
8. If the engine is cold, press and hold the **Choke** switch 10 (see Figure 8.14) during the next step.
9. Turn and hold the **Start** switch 11 clockwise (to the start position) until the engine starts or for 20 seconds, whichever comes first. When the engine starts, release both the start switch 11 and the choke switch 10 (see Figure 8.14).

⚠ CAUTION

If the engine does not start in 20 seconds, release the start switch 11 and release the Choke switch 10 then wait 60 seconds before trying to start the engine again.

→ Starting a diesel engine

To start a diesel engine from the platform control box do the following:

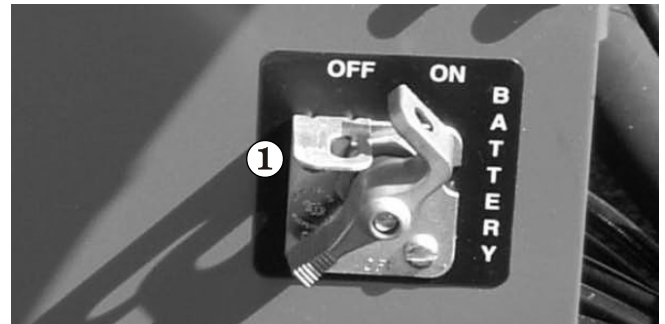

Figure 8.15

1. Set the **Battery** switch 1 to on (see Figure 8.15).



Figure 8.16

2. Set the **Emergency Stop** switch 2 to on (up) (see Figure 8.16).
3. Set the **Ground/Platform Selector** switch 3 to platform (up) (see Figure 8.16).
4. Turn the key 4 (see Figure 8.16) to on do not turn the key 4 to start.

8. Operation

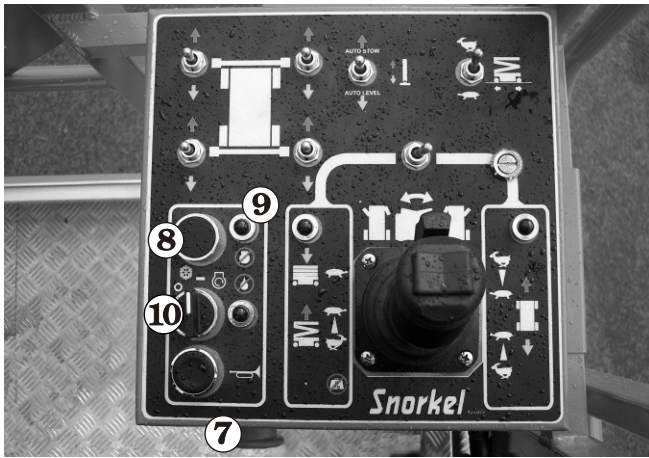

Figure 8.17

6. Turn the **Emergency Stop** switch **7** clockwise and it will pop out (on) (see Figure 8.17).
7. If the engine is at ambient temperature, momentarily press the GLOW-PLUG switch **8**. This action will automatically turn the glow-plugs, in the engine, on for 10 seconds. A light **9** will automatically come on to indicate that the glow-plugs are on (see Figure 8.17).
8. When the light **9** goes out, press and hold the START switch **10** until the engine starts or for 20 seconds, whichever comes first. When the engine starts, release the START switch **10** (see Figure 8.17).

⚠ CAUTION

If the engine does not start in 20 seconds, release the START switch **10** then wait 60 seconds before trying to start the engine again with the GLOW-PLUG **8** and START switches **10**.

■ Driving

1. The engine should be running. If not, start it from the platform control box as described previously.

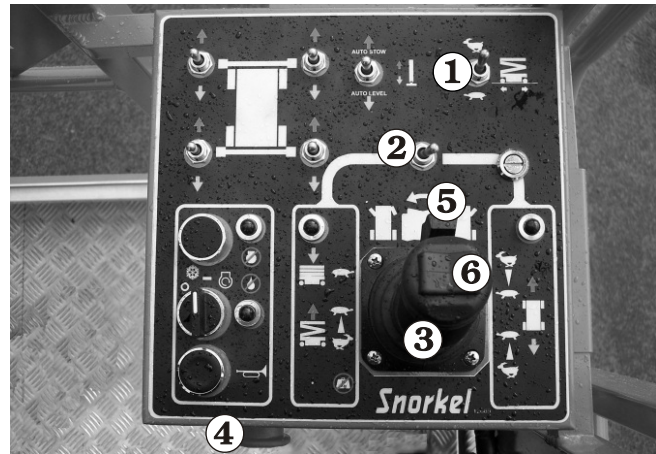

Figure 8.18

2. Set the **Speed** switch **1** to turtle (slow) (see Figure 8.18) if you are going to be driving close to other objects or need to move the SR very slowly for other reasons.

NOTE

Setting the SPEED to rabbit doubles the travel speed. (See the Specifications chapter for speeds of different models.)

3. Set the **Lift/Drive Selector** switch **2** to drive (right) (see Figure 8.18).

⚠ WARNING

The SR is about to move. If you have to make an emergency stop, release the Joystick Controller **3** and sharply strike the Emergency Stop switch **4** straight in.

To make a normal stop, slowly move the Joystick Controller **3** to its centered neutral position then release it.

4. Squeeze and hold the **Safety Control** **5** against the Joystick Controller **3** (see Figure 8.18).
5. Push the Joystick Controller **3** (see Figure 8.18) slowly forward or pull it slowly backward, depending on which way you want to go. The further you move the joystick the faster the SR moves.
6. To make a right or left turn, press and hold the **Steering** rocker-switch **6** on top of the Joystick Controller **3** (see Figure 8.18).

NOTE

When you release the **Steering rocker-switch** ⑥ the steering wheels remain pointed in the direction you left them. They do not return to straight ahead the way automobile wheels do. You will have to press the opposite side of the **Steering rocker-switch** ⑥ to return to straight line travel. In tight spots you should stop the SR, turn the wheels the direction you want to go, then, after you have aimed the steering wheels, squeeze the **Safety Control** ⑤ and move the **Joystick Controller** ③ slowly forward or backward.

□ Raising the Platform

To raise the platform from the platform control box do the following:

1. The engine must be running. If not, start it from the platform control box as described above.

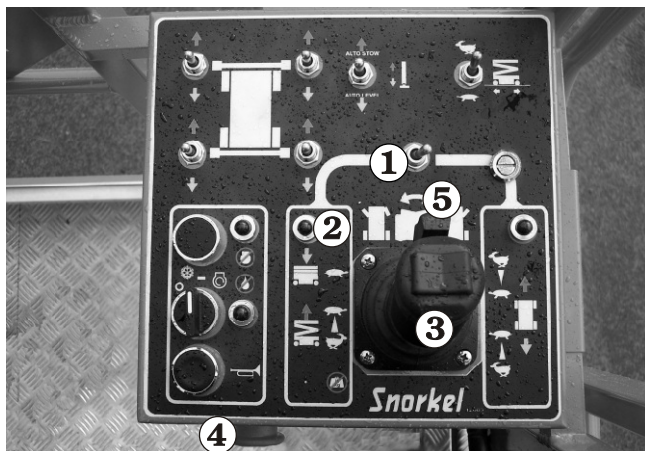

Figure 8.19

2. Set the **Lift/Drive Selector** ① (see Figure 8.19) to lift (left).

NOTE

If the **Lift Indicator Light** ② is not lit, the platform will not go up because: the chassis is not level, the stabilisers are not properly set, or the articulating axles are not set. Correct the problem then continue.

NOTE

The platform is about to move. If you have to make an emergency stop, release the **Joystick Controller** ③ and sharply strike the **Emergency Stop** switch ④ straight in.

To make a normal stop, slowly move the Joystick Controller ③ to its centered neutral position then release it.

3. Squeeze and hold the **Safety Control** ⑤ against the Joystick Controller ③ (see Figure 8.19).
4. Pull the **Joystick Controller** ③ backward to raise the platform, or push it forward to lower it. The further you pull the **Joystick Controller** ③ backward, the faster the platform rises. There is only one down speed.

■ Stabilisers

- **If your machine is not fitted with stabilisers you do not need to read this section.**

NOTE:

Using the stabilisers.

The platform must be fully lowered to enable the stabilisers to operate.

Once the platform is raised the stabilisers cannot be set or adjusted.

Before operating the stabilisers check to see that the ground conditions under the four stabiliser pads is firm, stable and unobstructed.

▲ DANGER

If the platform is up and the ground compresses unevenly under different stabiliser pads the SR might fall over causing serious injury or death. Check the level bubble frequently during operation. If any movement of the bubble occurs, immediately lower the platform and readjust the stabilisers to re-center the bubble in the ring.

When using the stabilisers always check that all four are firmly on the ground and that they are clear of manhole covers, drains, etc., which may collapse. If the ground is at all soft, steel plates at least 300mm x 300mm x 6mm should be placed under the feet to spread the weight.

▲ DANGER

Death or serious injury can result if an SR tips over. Do not use the stabilisers to gain extra working height, they are not designed for that purpose. At least one of the stabilisers should raise the SR above the ground - use the other three to level the SR as necessary.

The SR will not DRIVE unless all four stabilisers are completely raised i.e. If any one of the

8. Operation

stabilisers is even slightly lowered the DRIVE function is disabled.

■ Operating The Stabilisers Manually

□ To set the stabilisers

1. The engine must be running and the SR set for platform control box operation.



Figure 8.20

2. Pull and hold the **Stabiliser** switches 1 (see Figure 8.20) backward, one at a time, until all four stabiliser pads 2 (see Figure 8.21) contact the ground.

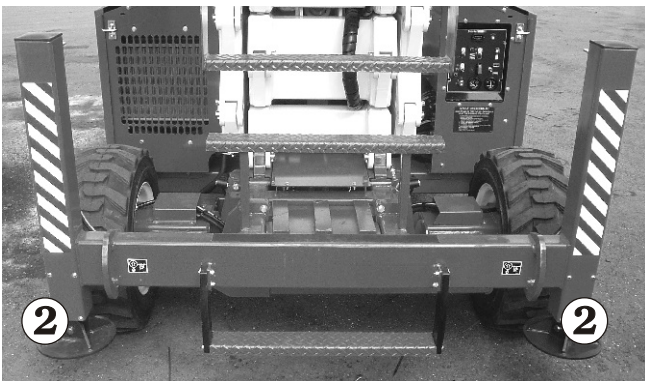

Figure 8.21

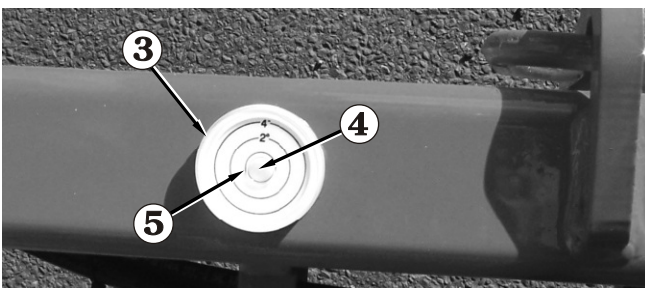

Figure 8.22

3. Visually check the bubble level 3 to determine which stabilisers must be further extended to level the platform (see Figure 8.22).

NOTE

When the bubble 4 in the bubble level is in the center of the ring 5, the platform is level.

4. Lower the appropriate stabilisers just enough to center the bubble 4 (see Figure 8.22). When the **Lift Indicator Light** 6 (see Figure 8.23) comes on, the platform can be safely raised.



Figure 8.23

□ To raise the stabilisers:

1. Completely lower the platform.

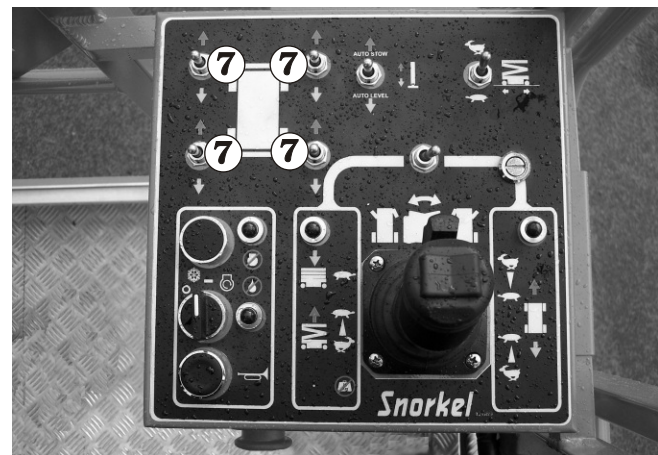

Figure 8.24

2. Push and hold the **Stabiliser** switches 7 forward until all the stabilisers are completely up (see Figure 8.24).

■ Operating The Auto Level System

□ Setting the stabilisers automatically

1. The engine must be running and the SR set for platform control box operation.

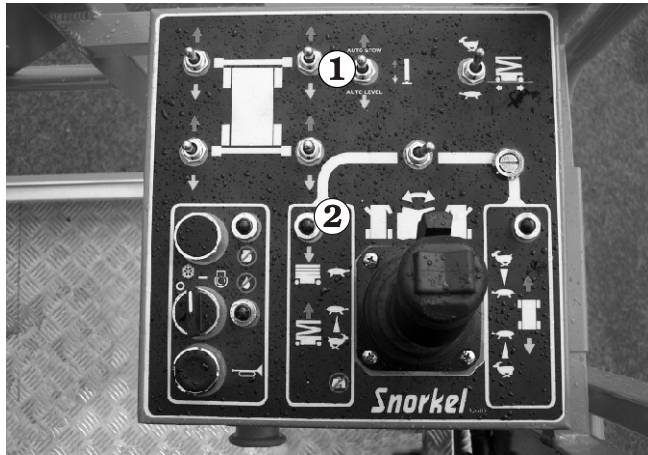

Figure 8.25

2. Press and hold the switch ① down to the 'Auto Level' position until all movement stops or the **Lift Enable Light** ② illuminates. The SR will attempt to automatically level itself.
3. The **Lift Enable Light** ② will illuminate if all 4 feet are in contact with the ground and the machine is level.
4. If a stabiliser foot will not go down sufficiently to make contact with the ground it is possible that the cylinder has reached the end of its stroke. Retract all stabilisers and put suitable dunnage under the feet that did not touch the ground and repeat step (2).

NOTE:

Manual or auto levelling is possible any time that stabiliser movement is allowed. For example, the machine can be manually levelled part way and then auto levelled without the necessity of retracting the stabilisers between the two operations.

□ Raising the stabilisers automatically

1. Completely lower the platform.
2. Press and hold the switch ① up to the 'Auto Stow' position. The stabilisers will raise to the stowed position.

■ Extending The Multi-Position Platform

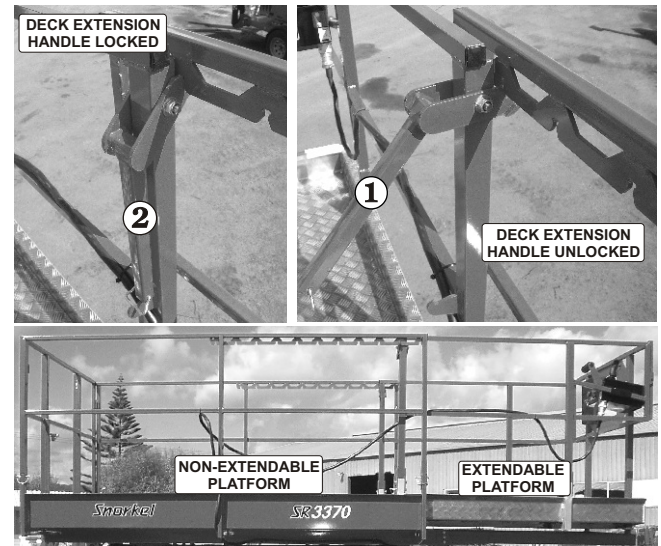

Figure 8.26

The MULTI-position extendible platform (see Figure 8.26) can be securely locked into different positions. To move it from one position to the other do the following:

1. Stand on the non-extendable part of the platform and face the front of the machine.

▲ WARNING

The distribution of the RATED WORK LOAD changes when the extendible platform is extended. Read the decal on the toe board at the front of the platform or at the entrance to the platform for safe weight distribution.

2. Lift up the deck extension handles (one for each side of the deck) ① to unlock the deck (see Figure 8.26).
3. Push or pull the deck extension handles to move the platform to the desired position.
4. Lower the deck extension handles and allow the lock ② to locate (see Figure 8.26).

■ Emergency Operation Procedures

The following procedures are emergency procedures only. **DO NOT** use them for normal operation. Their purpose is to get the platform and operator safely to the ground when the SR will not start or some other problem keeps the platform from lowering in the normal way, or to move the SR a short distance to a safe place when the motor will not start.

There are three forms of emergency operation for the SR. Emergency stop, emergency bleed-down, and pushing.

Each is covered as a separate section below.

■ Emergency Stop

There are two Emergency Stop switches on an SR.

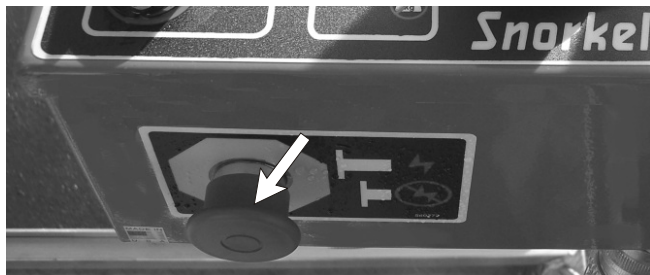

Figure 9.1 - Platform Control Box Emergency Stop Switch



Figure 9.2 - Ground Control Box Emergency Stop Switch

Push either **Emergency Stop** switch, (see Figures 9.1 and 9.2) at any time, and the entire machine stops, the engine turns off, and nothing moves.

Functionally, the **Emergency Stop** switches do the same thing as turning the **Main Power** switch to off. The **Emergency Stop** switches are designed to be easier to find and faster to use than key switches.

To reset the **Emergency Stop** switch at the platform control box, pull it and and it will pop out (on). To reset the **Emergency Stop** switch at the ground control box, raise the red switch-cover and push the switch up. The SR engine can then be restarted in the normal way.

■ Emergency Bleed-Down

The SR platform can be lowered from the platform control box anytime there is electricity to the platform control box the SR engine does not have to be running.

If you are working from the platform and the engine dies and cannot be restarted, do the following:

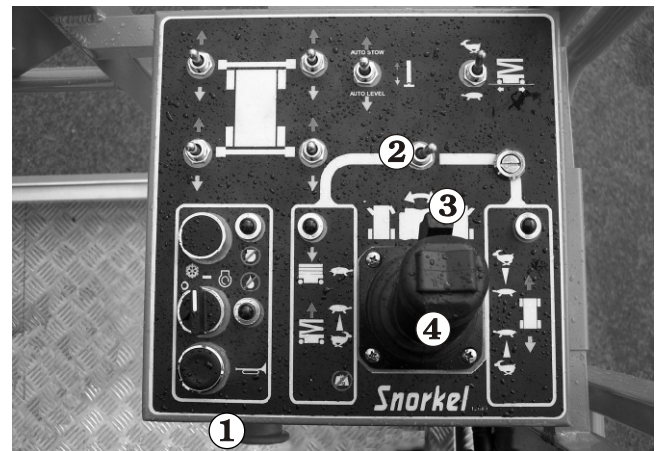

Figure 9.3

1. Check to be sure the **Emergency Stop** switch **1** is pulled out (on) (see Figures 9.1 and 9.3).
2. Set the **Selector** switch **2** (see Figure 9.3) to the platform function (left).
3. Squeeze the **Safety Control** **3** and push the **Joystick Controller** **4** (see Figure 9.3) forward. The platform should lower. If it does not lower, call for help from someone on the ground.

The person on the ground should do the following:

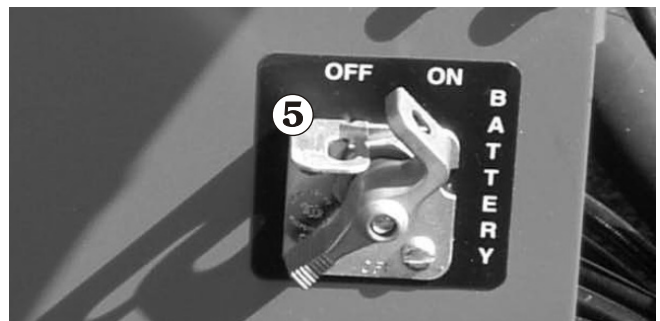

Figure 9.4

9. Emergency Operation

1. Check to be sure the **Battery** switch ⑤ is ON. (See Figure 9.4)



Figure 9.5

2. Check to be sure the **Emergency Stop** switch ⑥ (see Figure 9.5) is on (up).
3. Check to be sure the **Main Power** switch ⑦ is on (see Figure 9.5).
4. Check to be sure the **Selector** switch ⑧ is set to platform (up) (see Figure 9.5).
5. If the **Battery** Switch ⑤ (see Figure 9.4), **Emergency Stop** ⑥, **Main Power** ⑦, and **SELECTOR** switch ⑧ (see Figure 9.5) are all set correctly, and the engine will not start from the platform control box, set the **Selector** switch ⑧ to ground (down) and try to lower the platform from the ground control box.

▲ DANGER

Pinching And Crushing Hazard. At the next step the platform will come down and the scissor arms will close. Keep all body parts out of the scissor arms and out from under the platform.

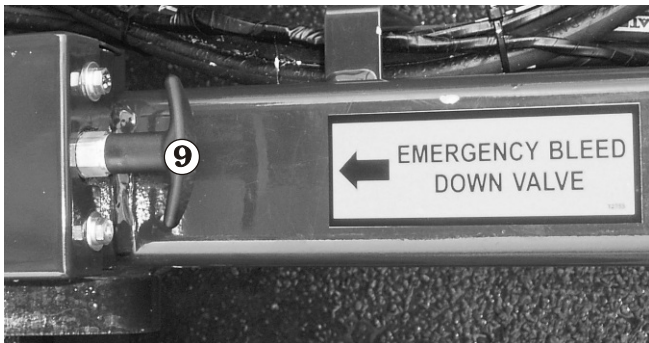

Figure 9.6 - Manual Bleed Down Control

6. If the platform will not lower, the person on the ground will need to use the manual bleed down ⑨ (see Figure 9.6) located at the front of the chassis. To lower the platform pull on the cable ⑨ until the platform is fully lowered.

NOTE

If the platform does not come down, refer the problem to a qualified trained service technician.

■ Pushing / Towing

An SR can be safely pushed or towed by hand on level firm surfaces. To do so:

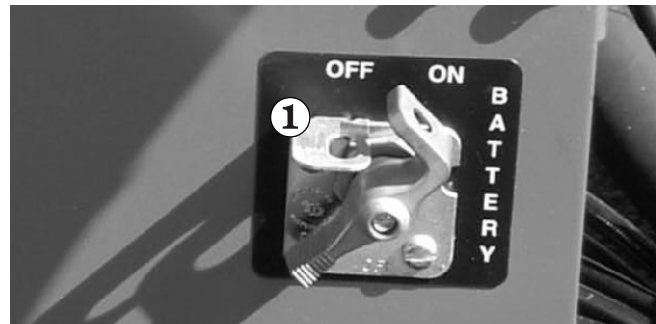

Figure 9.7

1. Turn the **Battery** switch ① to off (see Figure 9.7).

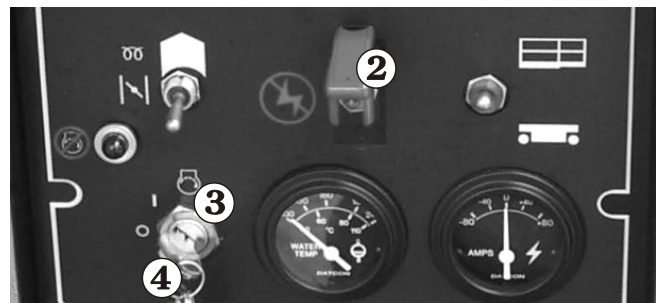

Figure 9.8

2. At the ground control box set the **EMERGENCY STOP** switch ② to off, turn the **MAIN POWER** switch ③ off and remove the key ④ (see Figure 9.8).

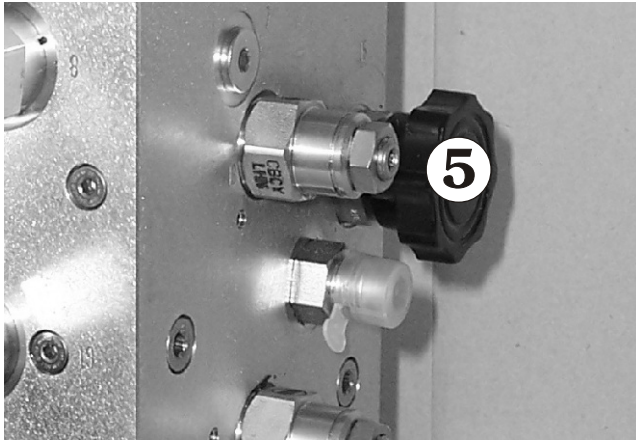

Figure 9.9

3. Inside the hydraulic compartment, open the free-wheeling valve ⑤ by turning counterclockwise until knob stops. (see Figure 9.9).

⚠ DANGER

A runaway SR can cause death or serious injury. At the next step the SR brakes will be released. Do not proceed to the next step unless the SR is on a level surface or the SR is securely attached to another vehicle that has the capacity to safely control the SR on a grade.

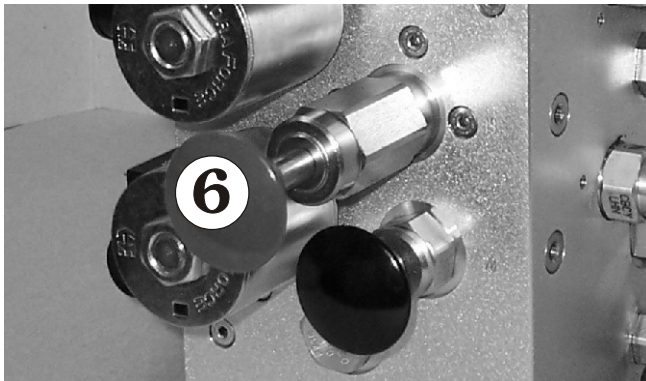

Figure 9.10

4. To release the brakes, pump the hand pump ⑥ 5 - 10 times. (see Figure 9.10). The brakes will now be released and the SR is ready to be pushed or towed.

⚠ CAUTION

The SR drive motors will be ruined if the SR is pushed (or pulled) faster than 2 mph (3.2 km/hr). Unless personnel safety considerations dictate otherwise, do not push (or pull) faster than 2 mph (3.2 km/hr).

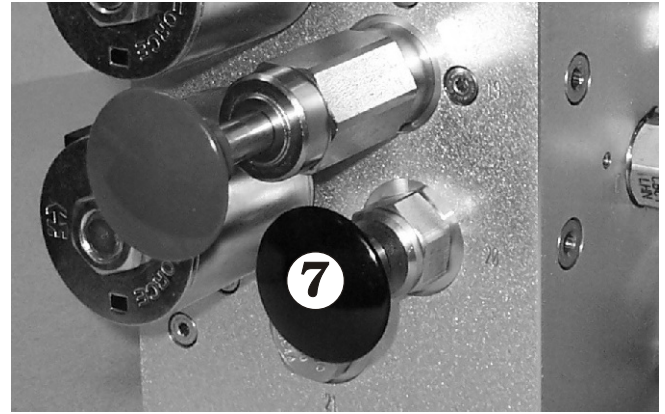

Figure 9.11

5. Once the unit has been safely pushed / towed pull the re-set knob ⑦ to re-apply the brakes (see Figure 9.11) and close the free-wheel valve ⑤ (see Figure 9.9).

The unit is now ready for normal operation.

10. Stowing and Transporting

■ Stowing

At the end of each work day (or in preparation for transporting, pushing, lifting, or storage) a qualified operator should put the SR into its stowed position then lock it.

The correct stowed position is shown here.



Figure 10.1 - Correct Stowed Position

To bring the SR into the **Stowed Position** use the controls on either the ground control box or the platform control box to:

1. Fully lower the platform.
2. Use the stabiliser controls to completely raise all four of the stabilisers.
3. Close the platform entry gate and close all the doors on the machine.

To lock an SR:



Figure 10.2

1. Push the **Emergency Stop** switch **7** down (OFF) and set the **Main Power** switch **8** to OFF then remove the key **9** (see Figure 10.2).

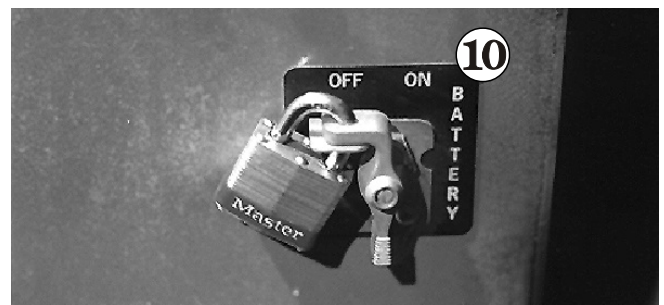

Figure 10.3

2. Turn the **Battery** switch **10** OFF and padlock it (see Figure 10.3).

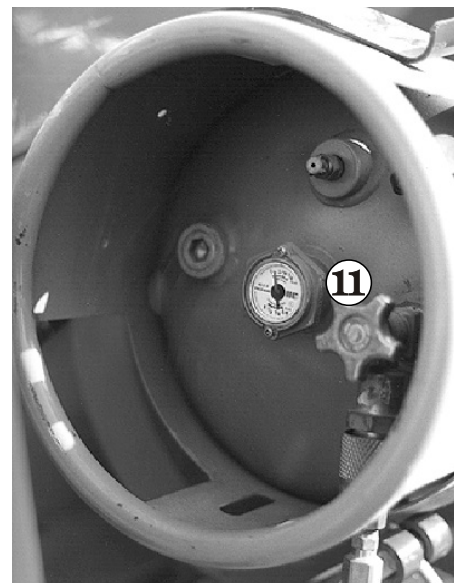

Figure 10.4

10. Stowing and Transporting

3. (Option - LPG) For machines equipped with LPG:
Close the valve **11** (see Figure 10.4) on the LPG-tank (completely screwed in).

■ Transporting

□ Trailering

▲ DANGER

SRs weigh up to 3620kg (7964lbs) depending on the model. Loading ramps must be able to support that weight. Transport trailers must be able to safely transport that weight.

SR brake and drive systems are not designed for grades over 35%. Drive slowly and carefully on all slopes and loading ramps.

To safely drive an SR onto a transport trailer:

1. Visually inspect the alignment of the loading ramp and the truck or trailer. They should both be on the same straight line.
2. Set the SR ground control box for platform operation.
3. Enter the platform and close the safety gate.
4. Use the platform controls to bring the SR into the STOWED POSITION at the foot of the loading ramp with the steering wheels nearest the ramp.
5. Visually check (from the platform) to be sure the SR is aligned with the ramp and the ramp is still aligned with the truck or trailer. All should be in a straight line.

▲ DANGER

Death or serious injury can result from losing control of an SR during loading or unloading. Always drive up or down a grade with the Speed switch set to turtle (slow).

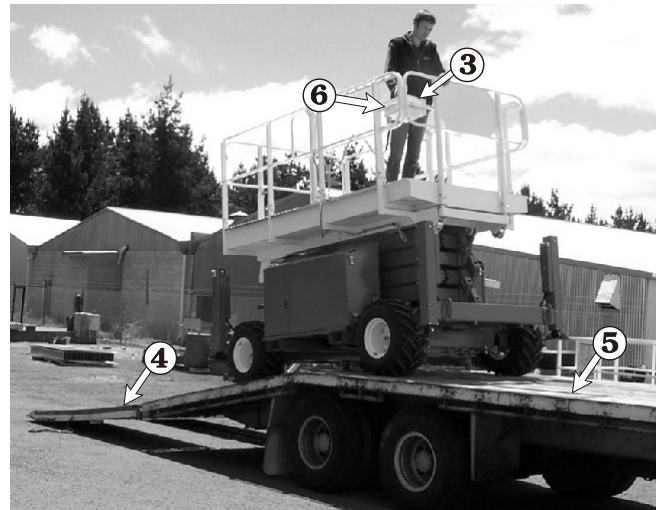

Figure 10.4

6. Use the joystick controller **3** to slowly drive the SR straight onto the ramp **4** and trailer **5** (see Figure 10.4).
7. When the SR is in place on the trailer, push the **Emergency Stop** switch **6** (see Figure 10.4) in (OFF) at the platform control box.
8. Chock the SR wheels.

□ Securing to a Transport Vehicle

This procedure assumes that you have just finished the previous section and that the wheels are chocked.

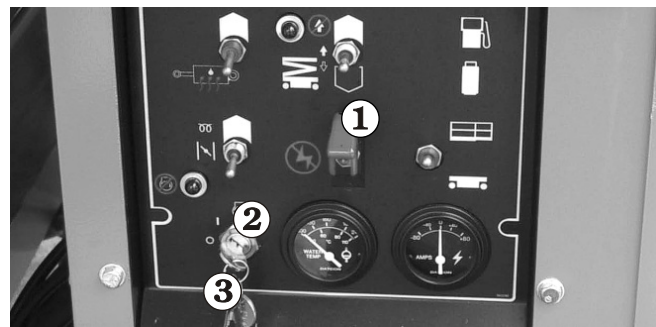

Figure 10.5

1. Push the **Emergency Stop** switch **1** down (OFF) and set the **Main Power** switch **2** to OFF then remove the key **3** (see Figure 10.5).

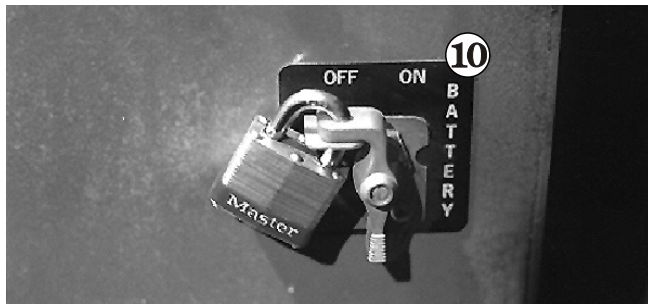

Figure 10.6

2. Set the **Battery** switch ⑩ (see Figure 10.6) to OFF and padlock it.

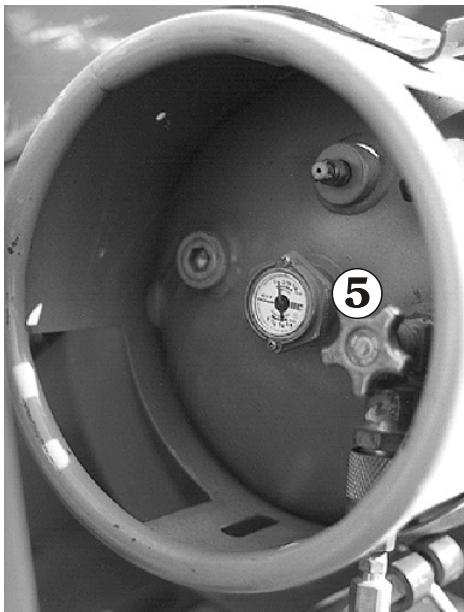

Figure 10.7

3. **(Option - LPG) For machines equipped with LPG:**
Close the valve ⑤ (see Figure 10.7) on the LPG tank (completely screwed in).

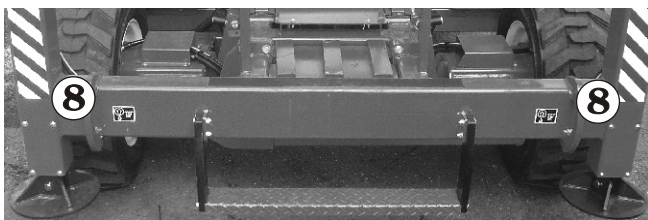

Figure 10.8 - Tie-down Lugs

Always attach chains to the front and back tie-down lugs ⑧ (see Figures 10.8 and 10.9).

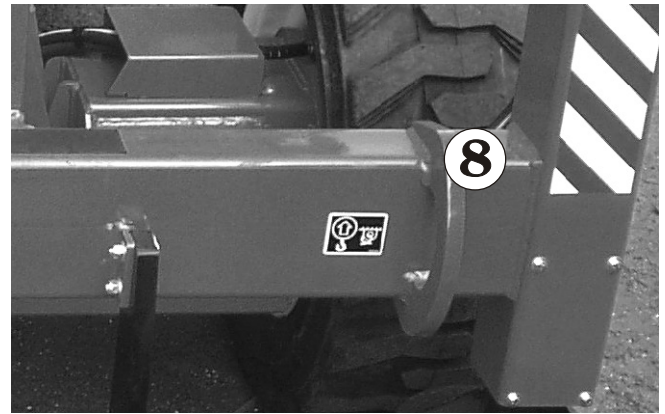

Figure 10.9 - Tie-down Lugs

Chocks may be removed at this time, though it is a good idea to leave them in place.

Reverse the above procedure after transporting.

Towing

Do not tow an SR. The SR hydraulic-drive motors will be permanently damaged, and rendered useless, by towing speeds.

Lifting / Lashing Down

An SR can be safely lifted. However, only a trained qualified service technician should perform lifting.

Pushing

An SR can be safely pushed by hand on level, firm surfaces. The procedure for pushing is located in the Emergency Operation chapter.

Winching Procedure

1. Locate transport vehicle so that SR will not roll forward after being loaded.
2. Fully lower platform and retract extension deck.
3. Be sure the machine is centered with the loading ramps and carrier vehicle bed, and that the steering wheels are straight.
4. Attach the winch at the tie down lugs on the front (steer) end of the chassis.
5. Disengage parking brakes and open free-wheeling valve to prevent damage to hydraulic motors. (Refer to procedures outlined for pushing in the Emergency Operation chapter 9.
6. Winch machine onto transport vehicle.
7. Close free-wheeling valve and reset parking brakes.

10. Stowing and Transporting

8. Reset the hydraulic system by reversing these procedures.

This chapter lists and explains the options available for an SR.

■ Bi-Energy Option

This consists of a combination of both a diesel engine and a 24V DC motor to give a Bi-Energy option.

Specifically, a 24V DC motor is mounted in the control cabinet. This provides an alternative power source to the diesel engine.

The DC motor is powered by four "Deep Cycle Traction Batteries" and has an automatic battery charger that is mounted in the control cabinet.

□ DC motor

The DC motor located in the control cabinet (see Figure 11.1)

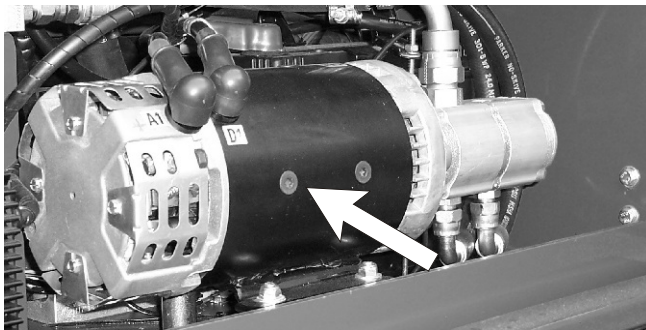

Figure 11.1 - DC Motor

□ DC motor operation

A Diesel / Electric switch, on the lower control box (see Figure 11.2) is used to select either the diesel engine or the DC motor.

If the diesel engine [SWITCH UP] is selected the DC motor will not function and if the DC motor (Electric) [SWITCH DOWN] is selected the diesel engine will not run.

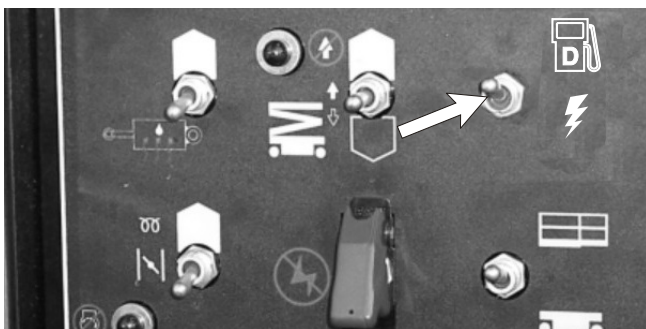

Figure 11.2 - Diesel/Electric Selection Switch

After selecting the DC mode, turn the ignition switch to the ON position (the second position of the switch) at the ground control box (see Figure 11.3)



Figure 11.3 - Start Switch, Ground

When entering the platform turn the ignition switch to the ON position (the second position of the switch) at the platform control box (see Figure 11.4).

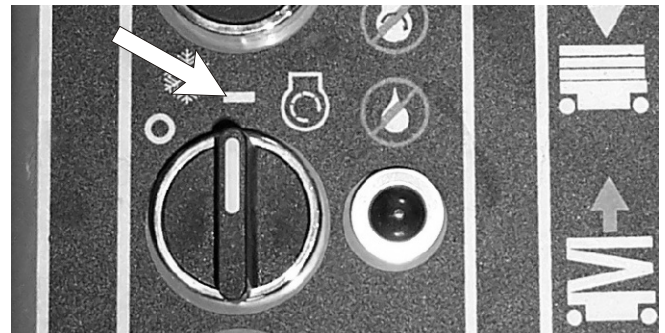

Figure 11.4 - Start Switch, Platform

Once the DC mode is selected the motor will then power all of the functions including the stabilisers in the normal manner. The only difference is that the DC motor will only "run" when a function is selected e.g. raising the stack.

□ Master battery isolater switches

There are two Master Battery Isolater Switches mounted at the end of the control cabinet (see Figure 11.5).

When the machine is not being used and is stowed both of these battery isolater switches should be turned to the "Off" position.

When operating with the **diesel motor** the 24V DC battery isolater switch should be turned to the "Off" position.

When operating the **24V DC motor** the Diesel battery isolater switch should be turned to the "Off" position.

11. Options

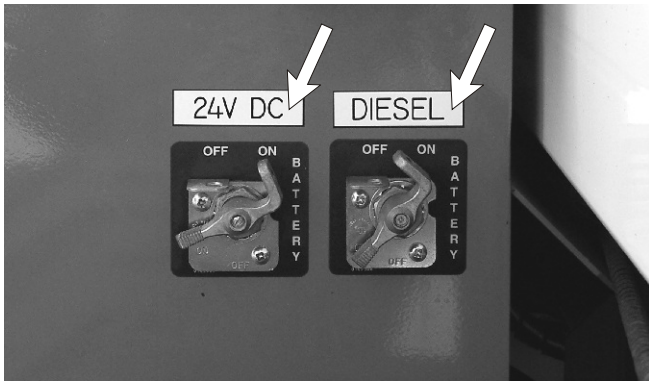

Figure 11.5 - Master Battery Isolator Switches

Steering in DC motor mode

Because of the configuration of the control mechanisms, when operating in DC motor mode and not driving, it is necessary to put a small amount of forward or reverse pressure on the joystick before the wheels will turn.

The technique for this will be quickly and easily acquired in use.

Batteries

Since the Bi-Energy SR is powered by "Deep Cycle Traction Batteries" particular attention should be paid to the batteries on-board charger to ensure proper operation.

The batteries are enclosed in a cabinet mounted at the front of the machine. (see Figure 11.6)

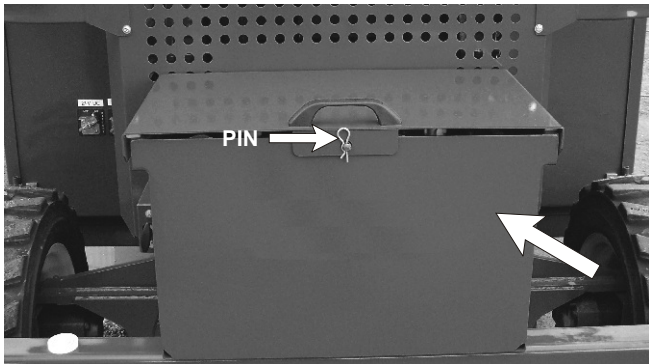

Figure 11.6 - DC Motor Battery Cabinet

Remove the locking pin, slide the cabinet lid forward and swing it downwards to gain access to the batteries (see Figure 11.7).

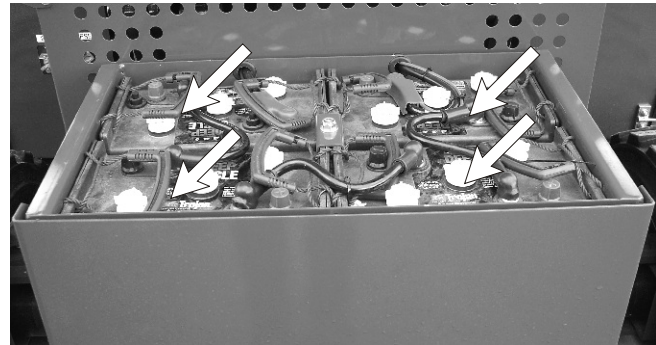

Figure 11.7 - DC Motor Batteries

▲ IMPORTANT

The cabinet lid must be open whilst charging to allow gasses to escape.

▲ DANGER

Lead-acid batteries contain sulphuric acid which will damage eyes or skin on contact. When working around batteries, ALWAYS wear a face shield to avoid acid in the eyes. If acid contacts eyes, flush immediately with clear water and get medical attention.

Wear rubber gloves and protective clothing to keep acid off the skin, if acid contacts the skin, wash it off immediately with clear water.

Lead-acid batteries produce flammable and explosive gasses. NEVER allow smoking, flames or sparks around batteries.

Battery charger

The Bi-Energy SR is fitted with an on-board automatic battery charger (see Figure 11.8). The charger will completely re-charge the batteries and automatically turn off after the cycle is completed.

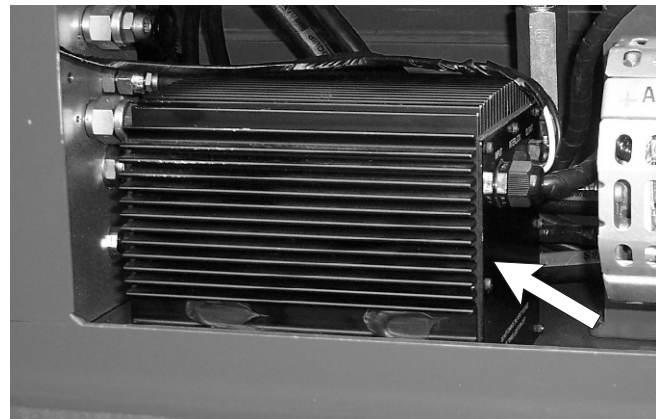

Figure 11.8 - On-Board Battery Charger

The battery charger is fitted with an 'interlock'. This means that during the charging cycle all functions on the machine are inoperative and will remain so until the charger unit is switched off.

The charging cycle may last from 1 to 12 hours depending on the state of the batteries.

If the charging cycle should exceed 16 hours (indicating a fault) the charger will automatically shut down and the batteries should be checked.

The inlet for connection of mains power to the charger is mounted on the external wall of the control cabinet above the battery isolator switches (see Figure 11.9)

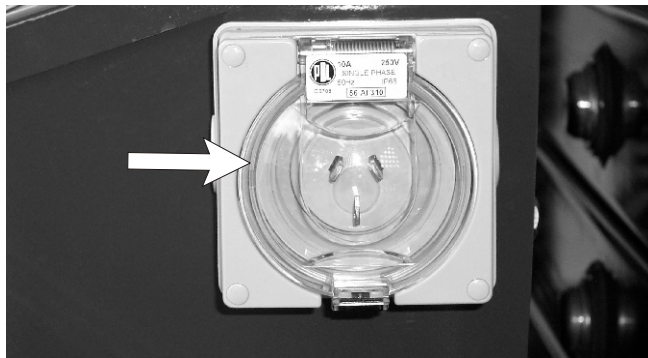

Figure 11.9 - Mains Power Connection For Charger

▲ IMPORTANT

DO NOT re-charge the batteries unless the electrolyte level has been checked.

▲ DANGER

DO NOT allow smoking, flames or sparks around batteries.

▲ IMPORTANT

DO ENSURE the cabinet lid is open during charging to allow gasses to escape.

□ Batteries - General maintenance

Always keep the batteries clean, free of dirt and corrosion. A film on top of the battery can accelerate discharge.

Cold reduces battery capacity and retards charging. Heat increases water usage and can (in extreme circumstances) result in overcharging.

Use distilled water to refill the batteries. Avoid water containing metallic solids such as iron.

□ Batteries - Charging

Fully recharge the batteries, immediately after use. One charging cycle per day is preferred. Fully charged batteries perform best. The deeper the discharge, the fewer number of cycles a battery will deliver. deep discharges deteriorate the battery quicker than shallow cycles.

An overly discharged battery may need to be cycled a few times before it can fully recover. If a battery begins to heat before becoming fully charged, it may be necessary to recharge and discharge the battery a few times.

The SR is equipped with an automatic battery charger that will completely recharge the batteries and turn off after the charge cycle is completed.

■ RCD / ELCB Outlet

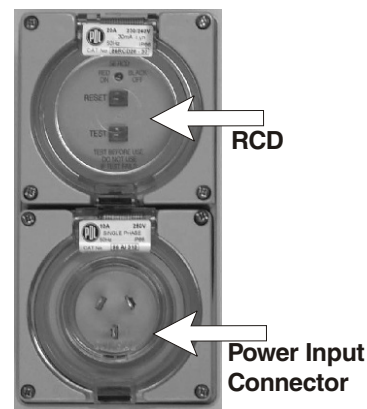

Figure 11.10 - RCD / ELCB Outlet

The RCD (Residual Current Device) is located at the ground and will protect against short circuits to earth. When there is a short circuit the RCD will shut down the 230v AC power to the platform outlet.

To reset the outlet disconnect the power tool lead from the platform box and reset the RCD at the ground.

If the problem persists call a trained service technician.

■ Flashing Light

The flashing light alerts people that the SR is present and that the SR is moving. The light flashes at about one flash per second any time the SR is running. There is no ON/OFF switch for the flashing light, it cannot be turned off while the SR is running.

11. Options

■ Lanyard Anchor Points

There are four anchors on the floor of the platform, one at the front of the roll-out deck, one at the back of the platform, and one on each side of the platform.

NOTE

These anchors are not for lifting or tying down the machine.

NOTE

You should attach your fall protection to the anchors if work rules require it.

■ Electrical Outlet

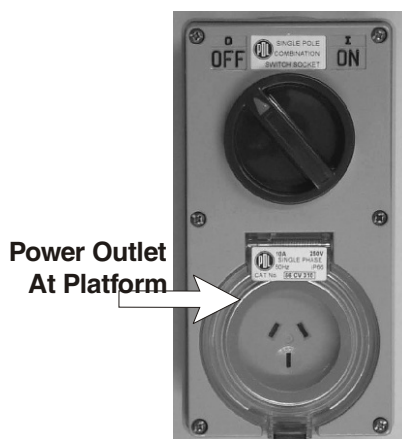

Figure 11.12 - Electrical Outlet

The electrical outlet on the platform, and its power cable, are designed to supply 2 kW of continuous duty power to run power tools of various sorts. The power can come from either the optional ac generator, discussed elsewhere in this chapter, or from an electrical source outside the SR. If you use an electrical source outside the SR be sure you disconnect it before you drive the SR away.

■ Non-Marking Tyres

These are tyres suited for using the SR in indoor situations.

■ Alternative Power Options

There are a number of alternative power options to the standard diesel engine.

- Gasoline powered engine
- LPG powered engine
- Combination LPG/Gasoline powered engine

■ Stabilisers

Stabilisers / No Stabilisers

■ Hazardous Components

The SR may contain some or all the following materials and objects that potentially could become significant fire or environmental hazards during the lifetime of the SR:

1. Antifreeze (ethylene glycol)
2. Battery, lead/acid
3. Diesel fuel
4. Foam in tires
5. Gasoline
6. Hydraulic oil
7. Liquefied petroleum gas
8. Motor oil

The rest of this chapter lists manufacturers information you will need if you ever have to control any of the above items during an upset or emergency.

□ Antifreeze (UN 1993)

☞ Fire extinguishing media:

Dry Chemical, foam, or CO₂.

☞ Special fire fighting procedures:

Water spray may be ineffective on fire but can protect fire fighters and cool closed containers. Use fog nozzles if water is used.

▲ DANGER

DO NOT enter confined fire space without full bunker gear. (Helmet with face shield, bunker coats, gloves & rubber boots). Use a NIOSH approved positive pressure self contained breathing apparatus. Keep container tightly closed. Isolate from oxidizers, heat and open flame.

☞ Spill or leak:

Small - mop up with absorbent material and transfer to hood.

☞ Waste disposal method:

Small - evaporate until all vapors are gone. Dispose of remainder by legally applicable methods.

□ Battery, Lead/Acid (UN 2794)

☞ Extinguishing media:

Dry chemical, foam, or CO₂.

☞ Special fire fighting procedures:

Use positive pressure, self contained breathing apparatus.

☞ Unusual fire and explosion hazards:

Hydrogen and oxygen gases are produced in the cells during normal battery operation.

▲ DANGER

Hydrogen gas is flammable and oxygen supports combustion. These gases enter the air through the vent caps. To avoid the chance of a fire or explosion, keep sparks and other sources of ignition away from the battery.

☞ Spill or leak:

Remove combustible materials and all sources of ignition. Contain spill by diking with soda ash (sodium carbonate) or quicklime (calcium oxide). Cover spill with either chemical. Mix well. Make certain mixture is neutral then collect residue and place in a drum or other suitable container. Dispose of as hazardous waste.

▲ DANGER

ALWAYS wear acid resistant boots, face shield, chemical splash goggles, and acid resistant gloves when handling acid spills or leaks.

NOTE

DO NOT release UN-neutralized acid!

☞ Waste disposal method:

Sulfuric Acid: Neutralize as above for a spill, collect residue, and place in a drum or suitable container. Dispose of as hazardous waste.

NOTE

DO NOT flush lead contaminated acid to sewer.

☞ Waste disposal method

Batteries: Send to lead smelter for reclamation following applicable federal, state, and local regulations.

□ Diesel Fuel (NA 1993)

☞ Extinguishing media:

Use water spray, dry chemical, foam, or CO₂.

12. Fire Fighting and Chemical Containment

☞ Special fire fighting procedures:

Use water to keep fire exposed containers cool. If leak or spill has not ignited, use water spray to disperse the vapors and to provide protection for personnel attempting to stop a leak. Water spray may be used to flush spills away from exposures.

☞ Unusual fire and explosion hazards:

Products of combustion may contain carbon monoxide, carbon dioxide, and other toxic materials.

▲ DANGER

DO NOT enter enclosed or confined space without proper protective equipment including respiratory protection.

☞ Spill or leak:

Contain spill immediately in smallest area possible. Recover as much of the product itself as possible by such methods as vacuuming, followed by soaking up of residual fluids by use of absorbent materials.

Remove contaminated items including contaminated soil and place in proper containers for disposal. Avoid washing, draining, or directing material to storm or sanitary sewers .

☞ Waste disposal method:

Recycle as much of the recoverable product as possible.

Dispose of non-recyclable material as a RCRA hazardous waste by such methods as incineration, complying with federal, state, and local regulations.

☐ Foam In Tires

☞ Extinguishing media:

Water, dry chemical, foam, or CO2.

☞ Special fire fighting procedures:

Evacuate non emergency personnel to a safe area.

☞ Unusual fire and explosion hazards:

Fire fighters should use self contained breathing apparatus. Avoid breathing smoke, fumes, and decomposition products.

Use water spray to drench smoldering elastomer. Product may melt, after ignition, to form flammable liquid.

▲ DANGER

Burning produces intense heat, dense smoke, and toxic gases, such as carbon monoxide, oxides of nitrogen, and traces of hydrogen cyanide.

☞ Spill or leak:

Pick up and handle as any other inert solid material.

☞ Waste disposal method:

Not considered a hazardous material. Dispose of material according to any local, state, and federal regulations.

☐ Gasoline (UN 1203)

☞ Extinguishing media:

Dry chemical, foam, or CO2.

☞ Special fire fighting procedures:

Water may be ineffective to extinguish, but water should be used to keep fire exposed containers cool. If a leak or spill has not ignited, use water spray to disperse the vapors and to protect personnel attempting to stop a leak. Water spray may be used to flush spills away from areas of potential ignition.

☞ Unusual fire and explosion hazards:

Highly Flammable. Products of combustion may contain carbon monoxide, carbon dioxide and other toxic materials.

▲ DANGER

DO NOT enter enclosed or confined space without proper protective equipment including respiratory protection.

☞ Spill or leak:

Review fire and explosion hazards before proceeding with clean up. Use appropriate personal protective equipment during clean up. Dike spill. Prevent liquid from entering sewers, waterways, or low areas. Soak up with sawdust, sand, oil dry or other absorbent material. Shovel or sweep up.

Remove source of heat, sparks, flame, impact, friction or electricity including internal combustion engines and power tools. If equipment is used for spill cleanup, it must be explosion proof and suitable for flammable liquid and vapor.

12. Fire Fighting and Chemical Containment

NOTE

Vapors released from the spill may create an explosive atmosphere.

☞ Waste disposal method:

Treatment, storage, transportation and disposal must be in accordance with applicable federal, state, provincial, and local regulations.

▲ CAUTION

DO NOT flush to surface water or sanitary sewer system. By itself, the liquid is expected to be a RCRA ignitable hazardous waste.

☐ Hydraulic Oil (UN 1270)

☞ Extinguishing media:

Use water spray, dry chemical, foam, or CO₂.

☞ Special fire fighting procedures:

Water or foam may cause frothing. Use water to keep fire exposed containers cool. Water spray may be used to flush spills away from exposures.

☞ Unusual fire and explosion hazards:

Products of combustion may contain carbon monoxide, carbon dioxide, and other toxic materials.

▲ DANGER

DO NOT enter enclosed or confined space without proper protective equipment including respiratory protection.

☞ Spill or leak:

Contain spill immediately in smallest area possible. Recover as much of the product itself as possible by such methods as vacuuming, followed by soaking up of residual fluids by use of absorbent materials.

Remove contaminated items including contaminated soil and place in proper containers for disposal. Avoid washing, draining or directing material to storm or sanitary sewers .

☞ Waste disposal method:

Recycle as much of the recoverable product as possible.

Dispose of non-recyclable material as a RCRA hazardous waste by such methods as incineration,

complying with federal, state, and local regulations.

☐ Liquefied Petroleum Gas (UN 1075)

☞ Extinguishing media:

Water spray. Class A-B-C or BC fire extinguishers.

☞ Special fire fighting procedures:

Stop flow of gas. Use water to keep fire exposed containers cool. Use water spray to disperse unignited gas or vapor.

If ignition has occurred and no water available, tank metal may weaken from over heating. Evacuate area. If gas has not ignited, LP gas liquid or vapor may be dispersed by water spray or flooding.

☞ Unusual fire and explosion hazards:

Highly Flammable. Products of combustion may contain carbon monoxide, carbon dioxide and other toxic materials.

▲ DANGER

DO NOT enter enclosed or confined space without proper protective equipment including respiratory protection.

☞ Spill or leak:

Keep public away. Shut off supply of gas. Eliminate sources of ignition. Ventilate the area. Disperse with water spray.

Contact between skin and these gases in liquid form can cause freezing of tissue causing injury similar to thermal burn.

NOTE

Vapors released from the spill may create an explosive atmosphere.

☞ Waste disposal method:

Treatment, storage, transportation and disposal must be in accordance with applicable federal, state, provincial, and local regulations.

☐ Motor Oil (UN 1270)

☞ Extinguishing media:

Use water spray, dry chemical, foam, or CO₂.

12. Fire Fighting and Chemical Containment

Special fire fighting procedures:

Water or foam may cause frothing. Use water to keep fire exposed containers cool. Water spray may be used to flush spills away from exposures.

Unusual fire and explosion hazards:

Products of combustion may contain carbon monoxide, carbon dioxide, and other toxic materials.

⚠ DANGER

DO NOT enter enclosed or confined space without proper protective equipment including respiratory protection.

Spill or leak:

Contain spill immediately in smallest area possible. Recover as much of the product itself as possible by such methods as vacuuming, followed by soaking up of residual fluids by use of absorbent materials.

Remove contaminated items including contaminated soil and place in proper containers for disposal. Avoid washing, draining or directing material to storm or sanitary sewers .

Waste disposal method:

Recycle as much of the recoverable product as possible.

Dispose of non-recyclable material as a RCRA hazardous waste by such methods as incineration, complying with federal, state, and local regulations.

■ Troubleshooting

All of the actions described in this chapter may be performed by an SR operator, a trained and qualified service technician is not required.

The first column, of the following chart, lists some common problems encountered by SR operators.

The second column lists some of the causes for each problem. The third column lists remedies.

□ Operator Troubleshooting Chart

▲ CAUTION

Any problem that cannot be fixed by actions listed below should be referred to a trained and qualified SR service technician.

Problem	Cause	Remedy
Engine will not start.	Battery switch set to off.	Turn battery switch to on.
	Emergency Stop switch(es) not on.	Set the ground control Emergency Stop switch to on (up). Also, if you are trying to start at the platform control box you should pull the Emergency Stop switch, at the platform control box, until it pops out (on).
	Key switch set to off.	Set the Key switch to on (the bar symbol).
	Ground/Platform Selector switch set to wrong location.	If you are trying to start from the ground control box, set the Ground/Platform selector to ground (down). If you are trying to start from the platform, set the selector to platform (up).
	Circuit Breaker tripped.	Push the circuit breaker in.
	Fuel switch not set correctly.	If you are trying to start a dual-fuel engine be sure the fuel switch is set to the correct fuel.
	Out of fuel.	DANGER: Keep flames and lit tobacco away from open fuel tanks. Remove the cap from the gasoline or diesel tank to see if there is fuel. Check the gauge(s) on top of the LP tank(s). If you are using LP gas, be sure the valve on top of the tank is open.
	Clogged air filter.	Visually check the air filter gauge.
Engine oil too thick for ambient temperature.	Check engine oil chart in "Specifications" chapter 3 for correct oil weight.	
Stabilisers inoperative	Platform not completely down.	Completely lower the platform.
All systems sluggish.	Hydraulic oil is too thick.	Check for correct grade of Hydraulic Oil. Allow time for machine to warm up.
SR will not drive forward or reverse.	Free-wheeling valve is open.	Close the free-wheeling valve.

13. Operator's Troubleshooting

Problem	Cause	Remedy
Platform will not go up or down.	Engine is not running.	Start the engine from the control station where you will operate the SR.
	Switches set wrong (Lift Indicator light is lit).	<p><u>For ground control operation:</u></p> <p>Ground/Platform Selector = Ground</p> <p><u>For platform control box operation:</u></p> <p>Ground/Platform Selector = Platform Lift/Drive Selector = Lift</p> <p>Squeeze and hold the Safety Control then push Joystick Controller forward to go up or pull it backward to go down.</p>
	SR is not level. (Lift Indicator light is not lit and the Level Sensor Alarm is sounding).	Use the stabilisers to level the SR.
	The Stabilisers are not properly set. (Lift Indicator light is not lit).	<p>If you are using the stabilisers, one or more of them is not down quite far enough. Lower each stabiliser a few inches more to be sure each is firmly in contact with the ground.</p> <p>If you are not using the stabilisers, one or more of them is not fully up. Raise each stabiliser completely up.</p>
Platform will not drive forward or reverse when raised.	Unit not level. Articulating axle operated.	Situation normal, lower platform to drive.

- ▶ **aerial platform**
a mobile device that has an adjustable position platform, supported from ground level by a structure.
- ▶ **ambient temperature**
the air temperature of the immediate environment.
- ▶ **ammeter**
an instrument for measuring the strength of an electric current in amperes.
- ▶ **authorized personnel**
personnel approved as assigned to perform specific duties at a specific location.
- ▶ **base**
the relevant contact points of the aerial platform that form the stability support (e.g. wheels, casters, outriggers, stabilisers).
- ▶ **boom**
a movable cantilever beam which supports the platform.
- ▶ **center of gravity**
the point in the aerial platform around which its weight is evenly balanced.
- ▶ **chassis**
the integral part of the aerial platform that provides mobility and support for the booms.
- ▶ **fall restraint**
a system that is used while working on a boom lift within the boundaries of platform guardrails to provide restraint from being projected upward from the platform. This system includes a harness or belt, lanyard, and a lanyard anchor. Federal OSHA, ANSI, and Snorkel require the use of additional fall protection beyond the platform guardrails on boom supported aerial platforms.
- ▶ **fall or ground pressure**
the maximum pressure, expressed in pounds per square inch, a single wheel concentrates on the floor or ground.
- ▶ **gradeability**
the maximum slope that the aerial platform is capable of travel.
- ▶ **ground fault circuit interrupter or residual current detector**
a fast-acting circuit breaker that opens to stop electrical circuit flow if it senses a very small current leakage to ground. Also called GFCI or RCD. The GFCI/RCD is used to protect personnel against a potential shock hazard from defective electrical tools or wiring.
- ▶ **guardrail system**
a vertical barrier around the platform to prevent personnel from falling.
- ▶ **hazardous location**
any location that contains, or has the potential to contain, an explosive or flammable atmosphere as defined by ANSI/NFPA 505.
- ▶ **jib boom**
a boom assembly located between the main boom and the platform.
- ▶ **level sensor**
a device that detects a preset degree of variation from perfect level. The level sensor is used to sound an alarm if operating on a slope greater than the preset value. It may also (depending on the machine) prevent the it from operating further until it is brought back within the preset parameters.
- ▶ **lower controls**
the controls located at ground level for operating some or all of the functions of the aerial platform.
- ▶ **main boom**
a boom assembly located between the turntable and the platform or jib boom. The main boom includes the base, intermediate, and tip boom.
- ▶ **maximum travel height**
the maximum platform height or the most adverse configuration(s) with respect to stability in which travel is permitted by the manufacturer.
- ▶ **Minimum Safe Approach Distance**
the minimum safe distance that electrical conductors may be approached when using the aerial platform. Also called MST
- ▶ **operation**
the performance of any aerial platform functions within the scope of its specifications and in accordance with the manufacturers instructions, the users work rules, and all applicable governmental regulations.

▶ **operator**

a qualified person who controls the movement of an aerial platform.

▶ **personal fall arrest system**

a fall protection system that is used while working on an unprotected edge (such as a roof top with no guardrail). This system includes a harness, lanyard or other connecting device, a fall arrestor, an energy absorber or decelerator, an anchorage connector, and a secure anchorage such as a building beam, girders or columns. An aerial platform is not a fall arrest anchorage.

▶ **platform**

the portion of an aerial platform intended to be occupied by personnel with their tools and materials.

▶ **platform height**

the vertical distance measured from the floor of the platform to the surface upon which the chassis is being supported.

▶ **prestart inspection**

a required safety inspection routine that is performed daily before operating the aerial platform.

▶ **qualified person**

a person, who by reason of knowledge, experience, or training is familiar with the operation to be performed and the hazards involved.

▶ **rated work load**

the designed carrying capacity of the aerial platform as specified by the manufacturer.

▶ **stow**

to place a component, such as the platform, in its rest position.

▶ **turning radius**

the radius of the circle created by the wheel during a 360° turn with the steering wheels turned to maximum. inside turning radius is the wheel closest to the centre and outside turning radius is the wheel farthest from the centre.

▶ **turntable**

the structure above the rotation bearing which supports the main boom. The turntable rotates about the centerline of rotation.

▶ **unrestricted rated work load**

the maximum designed carrying capacity of the aerial platform allowed by the manufacturer in all operating configurations.

▶ **upper controls**

the controls located on or beside the platform used for operating some or all of the functions of the aerial platform.

▶ **wheelbase**

the distance from the centre of the rear wheel to the centre of the front wheel.

▶ **working envelope**

the area defined by the horizontal and vertical limits of boom travel that the platform may be positioned in.

A

Additional information
 Introduction - page iv, A-v
 Automatic Shut-offs, 5-1
 Alternator Not Charging, 5-1
 Dynamic Brakes, 5-1
 Engine Oil Pressure, 5-1
 Engine Temperature, 5-1
 Level Sensor, 5-1
 Platform Height vs Drive Speed, 5-1
 Stabilisers, 5-1

C

Circuit Breakers, 5-2
 Main Circuit Breaker, 5-2
 RCD/ELCB Outlet, 5-2
 Controls, 6-1
 Control Switches
 Auto stabiliser, 6-3
 Battery, 6-1, 8-2, 8-3, 8-4
 Choke, 6-2, 6-3
 Emergency stop, 6-2, 8-1, 8-2, 8-3, 8-4, 9-1
 Fuel, 6-2
 Glow plug, 6-2, 6-3
 Ground/platform, 6-2
 Ground/platform selector, 8-2, 8-3, 8-4
 Joystick safety control, 6-3
 Key switch, 6-2
 Lift/drive, 6-3
 Manual stabiliser, 6-3
 Operator horn, 6-3
 Platform lift/lower, 6-2
 Speed, 6-3
 Start, 6-3
 Indicator Lights
 Choke, 6-2, 6-3
 Drive, 6-3
 Glow plug, 6-2, 6-3
 Lift, 6-3
 Lift enable, 6-2
 Low oil pressure, 6-3
 Joystick, 6-3
 Steering, 6-3

E

Electrical
 Electrocutation, 8-1
 Electrical Hazard Warning
 see Electrical Hazard - page i

Emergency Operation, 9-1
 Procedures
 Bleed down, 9-1
 Emergency stop, 9-1
 Pushing, 9-2

Engine
 Coolant, 3-3
 Fuel, 3-3
 Fuel grade, 3-3
 Make, 3-3
 Model, 3-3
 Oil capacity, 3-3
 Oil grade, 3-3
 Oil weight, 3-3
 Operating temperature, 3-3
 Running time, 3-3
 Engine Oil Charts, 3-3
 D905-B, 3-3
 WG750-G, 3-3

G

Gauges
 Ammeter, 4-1
 Bubble Level, 4-2
 Engine Oil, 4-1
 Hours, 4-2
 Hydraulic Oil, 4-1
 LPG Fuel Level, 4-2
 Water, 4-1
 General Specifications SR2770, 3-2
 General Specifications SR3370, 3-1
 Gradeability, 3-1, 3-2
 Ground clearance, 3-1, 3-2

H

Hazardous Components, 12-1
 Antifreeze, 12-1
 Battery Lead/Acid, 12-1
 Diesel Fuel, 12-1
 Foam In Tyres, 12-2
 Gasoline, 12-2
 Hydraulic Oil, 12-3
 Liquefied Petroleum Gas, 12-3
 Motor Oil, 12-3

I

Insulation rating, 3-1, 3-2

L

Lift time, 3-1, 3-2

Index

M

- Maintenance personnel
 - see Introduction - page iv
- Maximum rated axle capacity, 3-1, 3-2
- Minimum Safe Approach Distance
 - see Electrical Hazard - page ii

N

- Nominal working height, 3-1, 3-2

O

- Operating Procedures, 8-1
 - Control Stations, 8-1
 - Operating From Ground Controls, 8-2
 - Starting a gasoline, LP, or duel fuel engine, 8-2
 - Starting a gdiesel engine, 8-3
 - Operating From Platform Controls, 8-4
 - Starting a gasoline, LP, or duel fuel engine, 8-4
 - Raising The Platform, 8-3
- Operational Procedures
 - Driving, 8-6
 - Extending The Platform, 8-9
 - Raising The Platform, 8-7
 - Stabilisers, 8-7
 - Auto operation, 8-9
 - Manual operation, 8-8
- Overall height, 3-1, 3-2
- Overall length (with stabilizers), 3-1, 3-2
- Overall weight, 3-1, 3-2

P

- Placards and decals
 - Inspection drawing, 7-11
 - Standard placards and decals, 7-10
- Platform size, 3-1, 3-2

Q

- Qualified Operators
 - see Introduction - page iv

R

- Responsibilities of owners and users
 - Introduction - page iv, A-iv

S

- Safe working load (main deck), 3-1, 3-2
- Safe working load (roll out deck), 3-1, 3-2

Safety

- Batteries, 1-4
- Electrocution Hazard, 1-1
- Falling Hazard, 1-3
- Fuel Handling Precautions, 1-4
- General Safety Precautions, 1-3
- Hydraulic Systems, 1-3
- Pre-start Inspection, 1-2
- Safe Operation, 1-1
- Safety Decals, 1-4
- Tipover Hazard, 1-3
- Work Place Inspection and Practices, 1-2
- Safety Alerts, Caution, Danger, Warning, Important
 - see Introduction - page iii
- Safety Devices
 - Alarms, 2-1
 - Drive (forward), 2-2
 - Drive (reverse), 2-2
 - High temperature, 2-2
 - Level sensor, 2-2
 - Low oil pressure, 2-2
 - Lowering, 2-2
 - Bubble Level, 2-3
 - Emergency Stop Switches, 2-1
 - Flashing Light, 2-4
 - Guardrails, 2-2
 - Joystick Safety Control, 2-3
 - Lanyard Anchor Points, 2-4
 - Operator Horn, 2-3
 - RCD/ELCB AC Outlet, 2-3
 - Safety Prop, 2-2
 - Stabilisers, 2-3
 - Swinging Gate, 2-2
- Speed (maximum drive), 3-1, 3-2
- Stowing The SR, 10-1

T

- Transporting The SR, 10-2
 - Driving Onto Trailer, 10-2
 - Pushing, 10-3
 - Securing To Transport, 10-2
 - Towing, 10-3
 - Winching, 10-3
- Travelling height, 3-1, 3-2

Troubleshooting, 13-1, 13-2
 All systems sluggish, 13-1
 Engine will not start, 13-1
 Operator Troubleshooting Chart, 13-1
 Platform will not drive when raised, 13-2
 Platform will not go up, 13-2
 SR will not drive, 13-1
Turning radius (inner), 3-1, 3-2
Turning radius (outer), 3-1, 3-2

W

Warranty - Limited
 see inside front cover
Weight, 3-1, 3-2
Work Place Inspection, 1-2
Working height, 3-1, 3-2

**Local Distributor / Lokaler Vertiebshändler / Distributeur local
El Distribuidor local / Il Distributore locale**

**EUROPE, MIDDLE EAST
AFRICA & ASIA**

PHONE: +44 (0) 845 1550 057
FAX: +44 (0) 845 1557 756

NORTH & SOUTH AMERICA

PHONE: +1 785 989 3000
TOLL FREE: +1 800 255 0317
FAX: +1 785 989 3070

AUSTRALIA

PHONE: +61 2 9725 4000
FAX: +61 2 9609 3057

NEW ZEALAND

PHONE: +64 6 3689 168
FAX: +64 6 3689 164



www.snorkellifts.com