



Operators and Safety Manual

Model
3369electric
3969electric

3120880
March 8, 2000



AUSTRALIAN OFFICE

JLG INDUSTRIES, INC.
P.O. Box 5119
11 Bolwarra Road
Port Macquarie, Australia
Telephone: 065 811111
Fax: 065 810122

EUROPEAN OFFICE

JLG INDUSTRIES (EUROPE)
Kilmartin Place,
Tannochside Park
Uddingston, Scotland, G71 5PH
Telephone: 01698 811005
Main Fax: 01698 811055
Parts Fax: 01698 811455

CORPORATE OFFICE

JLG INDUSTRIES, INC.
1 JLG Drive
McConnellsburg, PA.
17233-9533
USA
Telephone: (717) 485-5161
Fax: (717) 485-6417

FOREWORD

The purpose of this manual is to provide users with the operating procedures essential for the promotion of proper machine operation for its intended purpose. It is important to over-stress proper machine usage. All information in this manual should be READ and UNDERSTOOD before any attempt is made to operate the machine. **YOUR OPERATING MANUAL IS YOUR MOST IMPORTANT TOOL** - Keep it with the machine. **REMEMBER ANY EQUIPMENT IS ONLY AS SAFE AS THE OPERATOR.**

BECAUSE THE MANUFACTURER HAS NO DIRECT CONTROL OVER MACHINE APPLICATION AND OPERATION, PROPER SAFETY PRACTICES ARE THE RESPONSIBILITY OF THE USER AND HIS OPERATING PERSONNEL.

ALL INSTRUCTIONS IN THIS MANUAL ARE BASED ON THE USE OF THE MACHINE UNDER PROPER OPERATING CONDITIONS, WITH NO DEVIATIONS FROM THE ORIGINAL DESIGN. ALTERATION AND/OR MODIFICATION OF THE MACHINE IS STRICTLY FORBIDDEN, WITHOUT WRITTEN APPROVAL FROM JLG INDUSTRIES, PER OSHA REGULATIONS AND APPLICABLE ANSI STANDARDS.



THIS SAFETY ALERT SYMBOL IS USED TO CALL ATTENTION TO POTENTIAL HAZARDS WHICH MAY LEAD TO SERIOUS INJURY OR DEATH IF IGNORED.

Safety of personnel and proper use of the machine are of primary concern, DANGER, WARNING, CAUTION, IMPORTANT, INSTRUCTIONS and NOTE are inserted throughout this manual to emphasize these areas. They are defined as follows:

DANGER

DANGER INDICATES AN IMMINENTLY HAZARDOUS SITUATION WHICH, IF NOT AVOIDED WILL RESULT IN SERIOUS INJURY OR DEATH.]

WARNING

WARNING INDICATES A POTENTIALLY HAZARDOUS SITUATION WHICH, IF NOT AVOIDED COULD RESULT IN SERIOUS INJURY OR DEATH.

CAUTION

CAUTION INDICATES A POTENTIALLY HAZARDOUS SITUATION WHICH, IF NOT AVOIDED, MAY RESULT IN MINOR OR MODERATE INJURY. IT MAY ALSO BE USED TO ALERT AGAINST UNSAFE PRACTICES

IMPORTANT

IMPORTANT OR INSTRUCTIONS INDICATES A PROCEDURES ESSENTIAL FOR SAFE OPERATION AND WHICH, IF NOT FOLLOWED, MAY RESULT IN A MALFUNCTION OR DAMAGE TO THE MACHINE.

IMPORTANT

JLG INDUSTRIES MAY HAVE ISSUED SAFETY RELATED BULLETINS FOR YOUR JLG PRODUCT. CONTACT JLG INDUSTRIES INC. OR THE LOCAL AUTHORIZED JLG DISTRIBUTOR FOR INFORMATION CONCERNING SAFETY RELATED BULLETINS WHICH MAY HAVE BEEN ISSUED FOR YOUR JLG PRODUCT. ALL ITEMS REQUIRED BY THE SAFETY RELATED BULLETINS MUST BE COMPLETED ON THE AFFECTED JLG PRODUCT

Due to continuous product improvements, JLG Industries, Inc. reserves the right to make specification changes without prior notification. Contact JLG Industries, Inc. for updated information.

This page left blank intentionally.

All procedures herein are based on the use of the machine under proper operating conditions, with no deviations from original design intent... as per OSHA regulations and applicable ANSI standards.

READ & HEED!

The ownership, use, service, and/or maintenance of this machine is subject to various governmental and local laws and regulations. It is the responsibility of the owner/user to be knowledgeable of these laws and regulations and to comply with them. The most prevalent regulations of this type in the United States are the Federal OSHA Safety Regulations*. Listed below, in abbreviated form are some of the requirements of Federal OSHA regulations in effect as of the date of publication of this handbook.

The listing of these requirements shall not relieve the owner/user of the responsibility and obligation to determine all applicable laws and regulations and their exact wording and requirements, and to comply with the requirements. Nor shall the listing of these requirements constitute an assumption of responsibility of liability on the part of JLG Industries, Inc.

1. Only trained and authorized operators shall be permitted to operate the aerial lift.
2. A malfunctioning lift shall be shut down until repaired.
3. The controls shall be plainly marked as to their function.
4. The controls shall be tested each day prior to use to determine that they are in safe operating condition.

5. All personnel in the platform shall, at all times, wear approved fall protection devices and other safety gear as required.
6. Load limits specified by the manufacturer shall not be exceeded.
7. Instruction and warning placards must be legible.
8. Aerial lifts may be field modified for uses other than those intended by the manufacturer only if certified in writing by the manufacturer to be in conformity to JLG requirements and to be at least as safe as it was prior to modification.
9. Aerial lifts shall not be used near electric power lines unless the lines have been de energized or adequate clearance is maintained.
10. Employees using aerial lifts shall be instructed on how to recognize and avoid unsafe conditions and hazards.
11. Ground controls shall not be operated unless permission has been obtained from personnel in the platform, except in case of an emergency.
12. Regular inspection of the job site and aerial lift shall be performed by competent persons.
13. Personnel shall always stand on the floor of the platform, not on boxes, planks, railing or other devices, for a work position.

*Applicable Federal OSHA regulations for the United States, as of the date of publication of this manual, include, but are not limited to, 29 CFR 1910.67, 29 CFR 1926.20, 29 CFR 1926.21, 29 CFR 1926.28, and 29 CFR 1926.453.

REVISION LOG

March 19, 1999 - Original Issue (This manual was part of complete manual 3120597)

Pages - 3-2 - 3-5 Updated March 8, 2000

TABLE OF CONTENTS

SUBJECT - SECTION, PARAGRAPH	PAGE NO.
SECTION - FOREWORD	
SECTION 1 - SAFETY PRECAUTIONS	
1.1 General	1-1
1.2 Driving/Towing/Carrying	1-1
1.3 Electrocutation Hazard	1-2
1.4 Pre-Operational	1-3
1.5 Driving	1-4
1.6 Operation	1-4
1.7 Towing and Hauling	1-6
1.8 Maintenance	1-6
SECTION 2 - PREPARATION AND INSPECTION	
2.1 General	2-1
2.2 Preparation for Use	2-1
2.3 Delivery and Periodic Inspection	2-1
2.4 Daily Walk-Around Inspection	2-2
2.5 Daily Functional Check	2-2
2.6 Torque Requirements	2-2
2.7 Battery Maintenance and Charging	2-3
SECTION 3 - USER RESPONSIBILITIES AND MACHINE CONTROL	
3.1 General	3-1
3.2 Personnel Training	3-1
3.3 Operating Characteristics and Limitations	3-1
3.4 Controls and Indicators	3-2
SECTION 4 - MACHINE OPERATION	
4.1 Description	4-1
4.2 General	4-1
4.3 Motor Operation	4-1
4.4 Raising and Lowering	4-2
4.5 Platform Extension	4-2
4.6 Platform Handrails Fold Down Procedure (in sequence)	4-2
4.7 Steering	4-2
4.8 Traveling (driving)	4-2
4.9 Parking and Stowing	4-3
4.10 Platform Loading	4-3
4.11 Safety Prop	4-4
4.12 Machine Tie Down	4-4
4.13 Machine Lifting	4-4
SECTION 5 - OPTIONAL EQUIPMENT	
5.1 Battery Discharge Indicator	5-1
5.2 Horn	5-1
5.3 Travel Alarm	5-1
5.4 Motion Alarm	5-1
5.5 Descent Alarm	5-1
5.6 Tilt Alarm Warning Light	5-1
5.7 Tilt Alarm	5-1
5.8 220 Volt Receptacle	5-1
5.9 Platform Lights	5-1
5.10 Non-marking Tires	5-1
5.11 Rotating Beacon Platform/Frame	5-1

TABLE OF CONTENTS (Continued)

SECTION 5 - OPTIONAL EQUIPMENT

5.12	High Output Batteries	5-1
5.13	Wheel Covers	5-1
5.14	Cylinder Bellows	5-1

SECTION 6 - EMERGENCY PROCEDURES

6.1	General	6-1
6.2	Emergency Towing Procedures	6-1
6.3	Emergency Controls and their Locations	6-1
6.4	Emergency Operation	6-1
6.5	Incident Notification	6-2

SECTION 7 - INSPECTION AND REPAIR LOG

LIST OF FIGURES

FIGURE NO.	TITLE	PAGE NO.
2-1.	Daily Walk-Around Inspection (Sheet 1 of 3)	2-4
2-1.	Daily Walk-Around Inspection (Sheet 2 of 3)	2-5
2-1.	Daily Walk-Around Inspection (Sheet 3 of 3)	2-6
2-2.	Lubrication Diagram	2-7
2-3.	Torque Chart	2-8
3-1.	Ground Control Station	3-3
3-2.	Platform Control Station	3-3
3-3.	Symbols	3-5
3-4.	Decal Location (Right Side & Rear)	3-6
3-5.	Decal Location (Left Side & Front)	3-7
4-1.	Grade and Sideslope	4-3
4-2.	Lifting Chart	4-4

LIST OF TABLES

TABLE NO.	TITLE	PAGE NO.
1-1	Minimum Safe Approach Distances (M.S.A.D.) to energized (exposed or insulated) power lines and parts	1-2
2-1	Lubrication Chart	2-7
7-1	Inspection and Repair Log	7-1

SECTION 1. SAFETY PRECAUTIONS

1.1 GENERAL

This section prescribes the proper and safe practices for major areas of machine usage which have been divided into three basic categories: Driving, Operation, and Maintenance. In order to promote proper usage of the machine, it is mandatory that a daily routine be established based on the instructions given in this manual. A maintenance program, using the information provided in the Service and Maintenance Manual, must also be established by a qualified person and must be followed to ensure that the machine is safe to operate.

The owner/user/operator/lessor/lessee of the machine should not accept operating responsibility until this manual has been read and operation of the machine, under the supervision of an experienced and qualified operator, has been completed. These sections contain the responsibilities of the owner, users, operators, lessors and lessees concerning safety, training, inspection, maintenance, application and operation. If there is a question on application and or operation, JLG Industries should be consulted

WARNING

MODIFICATION OR ALTERATION OF AN AERIAL PLATFORM SHALL BE MADE ONLY WITH PRIOR WRITTEN PERMISSION OF THE MANUFACTURER.

1.2 DRIVING/TOWING/CARRYING

Before driving the machine the user must be familiar with the drive, steer and stopping characteristics. This is especially important when driving in close quarters.

The user should be familiar with the driving surface before driving. The surface should be firm and level and grades should not exceed the allowable grade for the machine, 25%.

NOTE: *Remember that the key to safe and proper usage is common sense and its careful application.*

It is not recommended that this machine be towed, except in the event of a machine malfunction, a total machine power failure, or for loading on a truck. Refer to Section 6 for emergency towing procedures.

WARNING

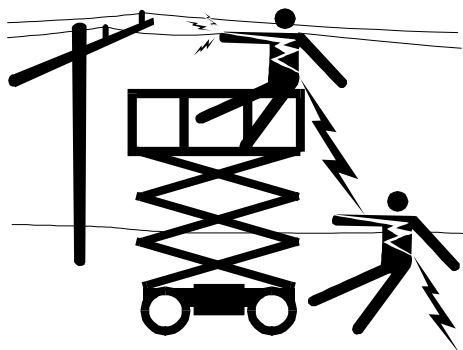
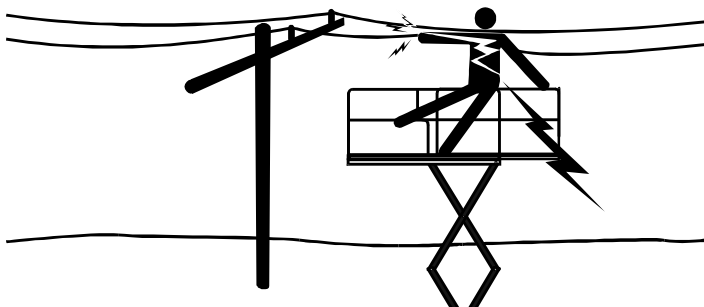
FAILURE TO COMPLY WITH SAFETY PRECAUTIONS LISTED IN THIS SECTION AND ON MACHINE MAY RESULT IN MACHINE DAMAGE, PERSONNEL INJURY OR DEATH AND IS A SAFETY VIOLATION.

Carrying or loading the unit should be accomplished using a forklift vehicle of suitable capacity with the forks being positioned correctly at the indicated areas on the machine frame. Refer to Section 4 for lifting information.

SECTION 1 - SAFETY PRECAUTIONS

Table 1-1.
Minimum Safe Approach Distances (M.S.A.D.) to energized (exposed or insulated) power lines and parts

VOLTAGE RANGE (Phase To Phase)	MINIMUM SAFE APPROACH DISTANCE Meters (Feet)
0 to 300V	AVOID CONTACT
Over 300V to 50KV	3 (10)
Over 50KV to 200KV	5 (15)
Over 200KV to 350KV	6 (20)
Over 350KV to 500KV	8 (25)
Over 500KV to 750KV	11 (35)
Over 750KV to 1000KV	14 (45)



1.3 ELECTROCUTION HAZARD

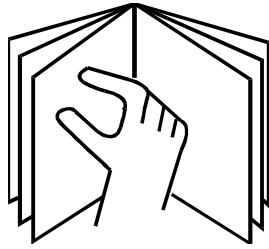
⚠ DANGER

DO NOT MANEUVER MACHINE OR PERSONEL INSIDE PROHIBITED ZONE. ASSUME ALL ELECTRICAL PARTS AND WIRING ARE ENERGIZED UNLESS KNOWN OTHERWISE.

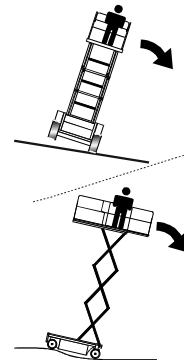
NOTE: MAINTAIN M.S.A.D. FROM ALL OTHER CHARGED LINES AND PARTS AS WELL AS THOSE SHOWN.

- MAINTAIN SAFE CLEARANCE FROM ELECTRICAL LINES AND APPARATUS. ALLOW FOR PLATFORM SWAY, ROCK OR SAG AND ELECTRICAL LINE SWAYING. THE MACHINE DOES NOT PROVIDE PROTECTION FROM CONTACT WITH OR PROXIMITY TO AN ELECTRICALLY CHARGED CONDUCTOR.
- MAINTAIN A CLEARANCE OF AT LEAST 3 METERS (10 FEET) BETWEEN ANY PART OF THE MACHINE OR ITS LOAD AND ANY ELECTRICAL LINE OR APPARATUS CARRYING UP TO 50,000 VOLTS. 0.3 METER (ONE FOOT) ADDITIONAL CLEARANCE IS REQUIRED FOR EVERY ADDITIONAL 30,000 VOLTS OR LESS.

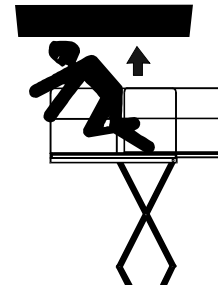
1.4 PRE-OPERATIONAL



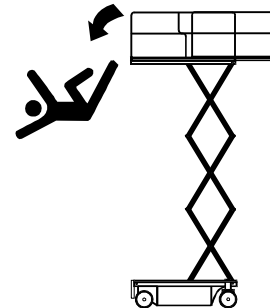
- READ YOUR MANUAL. UNDERSTAND WHAT YOU'VE READ - THEN BEGIN OPERATIONS.
- ALLOW ONLY THOSE AUTHORIZED AND QUALIFIED PERSONNEL TO OPERATE MACHINE WHO HAVE DEMONSTRATED THAT THEY UNDERSTAND SAFE AND PROPER OPERATION AND MAINTENANCE OF THE UNIT.
- AN OPERATOR MUST NOT ACCEPT OPERATING RESPONSIBILITIES UNTIL ADEQUATE TRAINING HAS BEEN GIVEN BY COMPETENT AND AUTHORIZED PERSONS.
- READ AND OBEY ALL WARNINGS, CAUTIONS AND OPERATING INSTRUCTIONS ON MACHINE AND IN THIS MANUAL.
- BE FAMILIAR WITH LOCATION AND OPERATION OF GROUND CONTROLS.
- BEFORE OPERATION CHECK WORK AREA FOR OVERHEAD ELECTRIC LINES, MACHINE TRAFFIC SUCH AS BRIDGE CRANES, HIGHWAY, RAILWAY AND CONSTRUCTION EQUIPMENT.
- PRECAUTIONS TO AVOID ALL KNOWN HAZARDS IN THE WORK AREA MUST BE TAKEN BY THE OPERATOR AND HIS SUPERVISOR BEFORE STARTING THE WORK.
- DO NOT OPERATE THIS MACHINE UNLESS IT HAS BEEN SERVICED AND MAINTAINED ACCORDING TO THE MANUFACTURERS SPECIFICATIONS AND SCHEDULE.
- ENSURE DAILY INSPECTION AND FUNCTION CHECK ARE PERFORMED PRIOR TO PLACING MACHINE INTO OPERATION.
- NEVER DISABLE OR MODIFY ANY SAFETY DEVICE. ANY MODIFICATION OF THE MACHINE IS A SAFETY VIOLATION AND IS A VIOLATION OF OSHA RULES.



- DO NOT OPERATE MACHINE WHEN WIND CONDITIONS EXCEED 12.5 M/S (30 MPH).
- NEVER OPERATE OR RAISE PLATFORM WHEN MACHINE IS ON A TRUCK OR OTHER VEHICLE.
- THIS MACHINE CAN BE OPERATED IN NOMINAL AMBIENT TEMPERATURES OF -20° C TO 40° C (0° F TO 104° F). CONSULT FACTORY TO OPTIMIZE OPERATION OUTSIDE THIS TEMPERATURE RANGE



- APPROVED HEAD GEAR MUST BE WORN WHEN REQUIRED BY ALL OPERATING AND GROUND PERSONNEL.

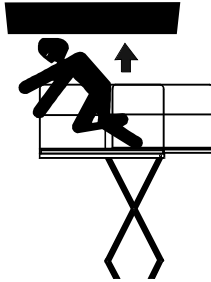


- ALWAYS USE 'THREE POINT CONTACT' WITH THE MACHINE. FACE THE MACHINE WHEN ENTERING OR LEAVING THE PLATFORM. 'THREE POINT CONTACT' MEANS THAT TWO HANDS AND ONE FOOT OR ONE HAND AND TWO FEET ARE IN CONTACT

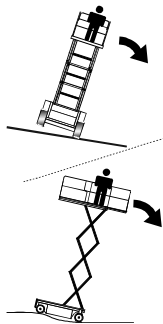
SECTION 1 - SAFETY PRECAUTIONS

WITH THE MACHINE AT ALL TIMES DURING MOUNT AND DISMOUNT.

1.5 DRIVING



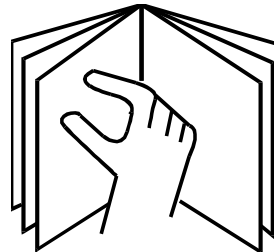
- WATCH FOR OBSTRUCTIONS AROUND MACHINE AND OVERHEAD WHEN DRIVING.



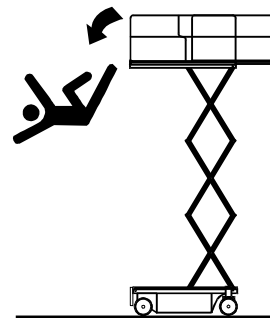
- CHECK TRAVEL PATH FOR PERSONS, HOLES, BUMPS, DROP-OFF, OBSTRUCTIONS, DEBRIS, AND COVERINGS WHICH MAY CONCEAL HOLES AND OTHER HAZARDS.
- DO NOT DRIVE WITH PLATFORM RAISED OR RAISE PLATFORM WHILE ON A SLOPING, UNEVEN, OR SOFT SURFACE.
- BEFORE DRIVING ON FLOORS, BRIDGES, TRUCKS AND OTHER SURFACES, CHECK ALLOWABLE CAPACITY OF SURFACES.
- DO NOT TRAVEL ON SOFT OR UNEVEN SURFACES, AS TIPPING WILL OCCUR.
- WHEN DRIVING IN HIGH SPEED, SWITCH TO LOW BEFORE STOPPING. TRAVEL GRADES IN LOW DRIVE ONLY. THE HYDRAULIC MOTORS GENERATE MAXIMUM TORQUE WHEN THE JOYSTICK IS PLACED IN THE SLOW DRIVE POSITION, MOTORS ALSO ACT AS SERVICE BRAKES .
- DO NOT USE HIGH SPEED DRIVE IN RESTRICTED OR CLOSE QUARTERS OR WHEN DRIVING IN REVERSE.

- BE AWARE OF STOPPING DISTANCES WHEN TRAVELING IN HIGH AND LOW SPEEDS.
- ALWAYS POST A LOOKOUT WHEN DRIVING IN AREAS WHERE VISION IS OBSTRUCTED.
- KEEP NON-OPERATING PERSONNEL AT LEAST 2.0 M (6 FT) AWAY FROM MACHINE DURING DRIVING OPERATIONS.

1.6 OPERATION



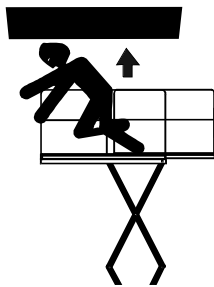
- READ YOUR MANUAL, UNDERSTAND WHAT YOU'VE READ - THEN BEGIN OPERATIONS.
- DO NOT OPERATE ANY MACHINE ON WHICH DANGER, WARNING, CAUTION OR INSTRUCTION PLACARDS OR DECALS ARE MISSING OR ILLEGIBLE.



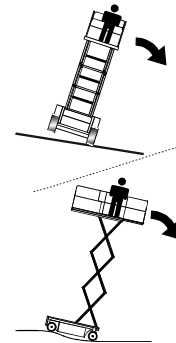
- NEVER USE SCISSOR ARMS TO GAIN ACCESS TO OR LEAVE PLATFORM.
- WHEN APPLICABLE BY REASON OF LOCAL REGULATIONS OR JOBSITE/EMPLOYER SAFETY RULES, ALL PERSONNEL IN THE PLATFORM SHALL AT ALL TIMES WEAR APPROVED FALL PROTECTION DEVICES AND OTHER SAFETY GEAR AS REQUIRED.
- TO AVOID FALLING - USE EXTREME CAUTION WHEN ENTERING OR LEAVING PLATFORM ABOVE GROUND. ENTER OR EXIT THRU GATE ONLY. PLATFORM MUST BE WITHIN 0.3 METER (1 FOOT) OF ADJACENT - SAFE AND SECURE - STRUCTURE.
- TRANSFERS BETWEEN A STRUCTURE AND THE PLATFORM EXPOSE OPERATORS TO FALL POTENTIALS. THIS PRACTICE SHOULD BE DISCOURAGED

WHEREVER POSSIBLE. WHERE TRANSFER MUST BE ACCOMPLISHED TO PERFORM THE JOB, TWO LANYARDS WILL BE USED. ONE LANYARD SHOULD BE ATTACHED TO THE PLATFORM, THE OTHER TO THE STRUCTURE. THE SAFETY LANYARD THAT IS ATTACHED TO THE PLATFORM SHOULD NOT BE DISCONNECTED UNTIL SUCH TIME AS THE TRANSFER TO THE STRUCTURE IS COMPLETE.

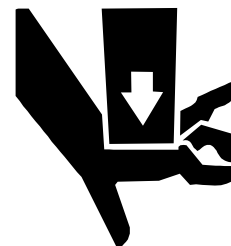
- NEVER POSITION LADDERS, STEPS, OR SIMILAR ITEMS ON UNIT TO PROVIDE ADDITIONAL REACH FOR ANY PURPOSE.
- WHEN RIDING IN OR WORKING FROM PLATFORM BOTH FEET MUST BE FIRMLY POSITIONED ON DECK.
- DO NOT EXTEND REACH LIMITS OF THIS MACHINE WITH ADDITIONAL EQUIPMENT SUCH AS PLANKS, BOXES, ETC.
- DO NOT OPERATE WITHOUT HANDRAILS IN PLACE AND SECURED. IT IS A SAFETY VIOLATION.
- DO NOT STEP OUTSIDE OF HANDRAILS.
- AVOID ACCUMULATION OF DEBRIS ON PLATFORM WORK AREA. KEEP MUD, OIL, GREASE AND OTHER SLIPPERY SUBSTANCES FROM FOOTWEAR AND PLATFORM DECK.



- CHECK CLEARANCES ABOVE, ON SIDES AND BOTTOM OF PLATFORM WHEN RAISING AND LOWERING PLATFORM.
- EXERCISE EXTREME CAUTION AT ALL TIMES TO PREVENT OBSTACLES FROM STRIKING OR INTERFERING WITH OPERATING CONTROLS AND PERSONS IN THE PLATFORM.
- ENSURE THAT OPERATORS OF OTHER OVERHEAD AND FLOOR LEVEL MACHINES ARE AWARE OF THE AERIAL PLATFORM'S PRESENCE. DISCONNECT POWER TO OVERHEAD CRANES. BARRICADE FLOOR AREA IF NECESSARY.



- NEVER EXCEED MANUFACTURERS RATED PLATFORM CAPACITY - REFER TO CAPACITY DECAL ON MACHINE. DISTRIBUTE LOAD EVENLY ON PLATFORM FLOOR.
- ENSURE MACHINE IS POSITIONED ON A FIRM, LEVEL AND UNIFORM SUPPORTING SURFACE BEFORE RAISING PLATFORM.
- DO NOT ADD NOTICE BOARDS OR SIMILAR ITEMS TO PLATFORM. ADDITION OF SUCH ITEMS INCREASES EXPOSED WIND AREA OF MACHINE.
- DO NOT ATTACH OVERHANGING LOADS TO THE PLATFORM OR INCREASE THE PLATFORM SIZE WITH UNAUTHORIZED DECK EXTENSIONS OR ATTACHMENTS.
- DO NOT ELEVATE PLATFORM UNLESS MACHINE IS LEVEL.
- DO NOT TIE OFF MACHINE TO ANY ADJACENT STRUCTURE. NEVER ATTACH WIRE, CABLE OR ANY SIMILAR ITEMS TO PLATFORM.



- DURING OPERATION KEEP ALL BODY PARTS INSIDE PLATFORM RAILINGS.
- KEEP NON-OPERATING PERSONNEL AT LEAST 2.0M (6 FT) AWAY FROM MACHINE DURING OPERATION.
- NEVER 'SLAM' A CONTROL SWITCH OR LEVER THROUGH NEUTRAL TO OPPOSITE DIRECTION. ALWAYS RETURN SWITCH TO NEUTRAL AND STOP; THEN MOVE SWITCH TO THE DESIRED POSITION. OPERATE LEVERS WITH SLOW, EVEN PRESSURE.
- DO NOT CARRY MATERIALS ON PLATFORM RAILING

SECTION 1 - SAFETY PRECAUTIONS

- NEVER OPERATE A MALFUNCTIONING MACHINE. IF A MALFUNCTION OCCURS, SHUT DOWN THE MACHINE, RED TAG IT, AND NOTIFY PROPER AUTHORITIES.
- NO STUNT DRIVING OR HORSEPLAY IS PERMITTED.
- DO NOT ALLOW PERSONNEL TO TAMPER WITH, SERVICE, OR OPERATE THIS MACHINE FROM THE GROUND WITH PERSONNEL IN PLATFORM EXCEPT IN AN EMERGENCY.
- WHEN TWO OR MORE PERSONS ARE IN PLATFORM, THE OPERATOR SHALL BE RESPONSIBLE FOR ALL MACHINE OPERATIONS.
- ALWAYS ENSURE THAT POWER TOOLS ARE PROPERLY STOWED AND NEVER LEFT HANGING BY THEIR CORD FROM THE PLATFORM WORK AREA.

1.7 TOWING AND HAULING

- TOW OR PULL MACHINE IN THE EVENT OF AN EMERGENCY ONLY. TO MOVE MACHINE, CARRY MACHINE WITH FORKLIFT OF SUITABLE CAPACITY.
- HAVE PLATFORM COMPLETELY EMPTY OF TOOLS AND DEBRIS BEFORE CARRYING.
- WHEN LIFTING MACHINE, POSITION FORKS ONLY AT DESIGNATED AREAS AT FRONT OR REAR OF MACHINE.
- HAVE PLATFORM FULLY RETRACTED WHILE MACHINE IS BEING CARRIED.
- NEVER ALLOW PERSONNEL IN PLATFORM WHILE CARRYING.

1.8 MAINTENANCE

This section contains the general safety precautions which must be observed during maintenance of the aerial work platform. It is of utmost importance that maintenance personnel pay strict attention to these warnings and precautions to avoid possible injury to themselves or others or damage to the equipment. A maintenance program must be established by a qualified person and must be followed to ensure that the machine is safe to operate.

⚠ WARNING

MODIFICATION OF THE MACHINE WITHOUT CERTIFICATION BY A RESPONSIBLE AUTHORITY THAT THE MACHINE IS AT LEAST AS SAFE AS ORIGINALLY MANUFACTURED IS A SAFETY VIOLATION.

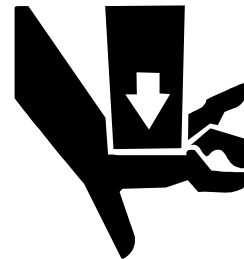
The specific precautions to be observed during machine maintenance are inserted at the appropriate point in the manual. These precautions are, for the most part, those

that apply when servicing hydraulic and larger machine component parts.

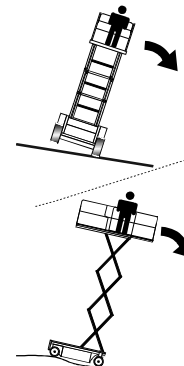
Your safety, and that of others, is the first consideration when engaging in the maintenance of equipment. Always be conscious of weight.

Never attempt to move heavy parts without the aid of a mechanical device. Do not allow heavy objects to rest in an unstable position. When raising a portion of the equipment, ensure that adequate support is provided.

- ALWAYS DISCONNECT BATTERIES WHEN REPLACING ELECTRICAL COMPONENTS.
- REMOVE RINGS, WATCHES AND JEWELRY WHEN PERFORMING ANY MAINTENANCE.
- DO NOT WEAR LOOSE FITTING CLOTHING OR LONG HAIR UNRESTRAINED, WHICH IS APT TO BECOME CAUGHT ON, OR ENTANGLED IN EQUIPMENT.
- USE ONLY CLEAN APPROVED NONFLAMMABLE CLEANING SOLVENTS.
- SHUT OFF ALL POWER CONTROLS BEFORE MAKING ADJUSTMENTS, LUBRICATING OR PERFORMING ANY OTHER MAINTENANCE.



- NEVER WORK UNDER AN ELEVATED PLATFORM UNTIL IT HAS BEEN RESTRAINED FROM MOVEMENT WITH SAFETY PROPS, BLOCKING OR OVERHEAD SLING.



- NEVER ALTER, REMOVE OR SUBSTITUTE ANY ITEMS SUCH AS COUNTERWEIGHTS, SOLID TIRES, BATTERIES, ETC. WHICH WOULD REDUCE THE OVERALL WEIGHT OR BASE STABILITY OF THE MACHINE.

SECTION 2. PREPARATION AND INSPECTION

2.1 GENERAL

This section provides the necessary information needed by those personnel that are responsible to place the machine in operation readiness, and lists checks that are performed prior to use of the machine. It is important that the information contained in this section be read and understood before any attempt is made to operate the machine. Ensure that all the necessary inspections have been completed successfully before placing the machine into service. These procedures will aid in obtaining maximum service life and safe operation.

IMPORTANT

SINCE THE MACHINE MANUFACTURER HAS NO DIRECT CONTROL OVER THE FIELD INSPECTION AND MAINTENANCE, SAFETY IS THE RESPONSIBILITY OF THE OWNER/OPERATOR.

2.2 PREPARATION FOR USE

1. Before a new machine is put into operation it must be carefully inspected for any evidence of damage resulting from shipment and inspected periodically thereafter, as outlined in the Delivery and Periodic Inspection. The unit should be thoroughly checked for hydraulic leaks during initial start-up and run. A check of all components should be made to assure their security.
2. All preparation necessary to place the machine in operation readiness status are the responsibility of management personnel. Preparation requires good common sense, (i.e. lift works smoothly and brakes operate properly), coupled with a series of visual inspections. The mandatory requirements are given in the Daily Walk Around Inspection.
3. It should be assured that the items appearing in the Delivery and Periodic Inspection and Functional Check are complied with prior to putting the machine into service.

2.3 DELIVERY AND PERIODIC INSPECTION

NOTE: *This machine requires periodic safety and maintenance inspections by a JLG Dealer.*

The following checklist provides a systematic inspection to assist in detecting defective, damaged, or improperly installed parts. The checklist denotes the items to be inspected and conditions to examine.

Periodic inspection shall be performed monthly or more often when required by environment, severity, and frequency of usage.

This inspection checklist is also applicable and must be followed for all machines that have been in storage or for all machines that will be exposed to harsh or changing climates.

These checks are also to be performed after maintenance has been performed on the machine.

1. Handrail Assemblies - Properly installed; no loose or missing parts; no visible damage.
2. Platform Assembly - No visible damage; free of dirt and debris.
3. Sizzor Arms - No visible damage; abrasions and/or distortions.
4. Electrical Cable - No visible damage; properly secured.
5. Pivot Pins - No loose or missing retaining hardware; no damage or wear to pin heads which would cause pin to rotate; no evidence of pin or bushing wear.
6. Lift Cylinder - No rust, nicks, scratches or foreign material on piston rod. No leakage.
7. Frame - No visible damage; loose or missing hardware (top and underside).
8. Drive Hubs - Check oil level in drive hub by removing pipe plug and feeling for oil level. (Contact service personnel for assistance if needed).

NOTE: *Torque hubs should be one-half full of lubricant.*

9. Tire and Wheel Assemblies - No loose or missing lug nuts; no visible damage.
10. Sliding Wear Pad Blocks - No excessive wear; adequate lubrication.
11. Hydraulic Oil Supply - Operate hydraulic system through one complete cycle before checking oil level in hydraulic oil tank. Oil should be visible on side of hydraulic oil tank. If oil is not to FULL mark, add oil until oil is to FULL mark on tank. Do not over-fill tank.
12. Steer Cylinder - No rust, nicks, scratches or foreign material on piston rod; No leakage.
13. Steer Linkage - No loose or missing parts; no visible damage.
14. Steer Spindle Assemblies - No excessive wear; no damage.

SECTION 2 - PREPARATION AND INSPECTION

15. Control Boxes - (Console and Ground) - Switches operable; no visible damage; placards secure and legible. Hand controller operable; no visible damage.
16. Batteries - Proper electrolyte level; cable connections tight; no visible damage; no corrosion at battery cable connections.
17. Hydraulic Pump - No leakage; units secure.
18. Platform Placard - No visible damage; placards secure and legible.

2.4 DAILY WALK-AROUND INSPECTION

It is the users responsibility to inspect the machine before the start of each workday. It is recommended that each user inspect the machine before operation, even if the machine has already been put into service under another user. This Daily Walk-Around Inspection is the preferred method of inspection.

These checks are also to be performed after maintenance has been performed on the machine.

In addition to the Daily-Walk Around Inspection be sure to include the following as part of the daily inspection:

Overall Cleanliness

Check all standing surfaces for hydraulic oil spillage and foreign objects. Ensure overall cleanliness.

Placards

Keep all information and operating placards clean and unobstructed. Cover when spray painting or shot blasting to protect legibility. Uncover prior to machine operation

Operators and Safety and Service and Maintenance Manual

Ensure that a copy of this manual is enclosed in the manual storage holder.

Machine Log

Ensure a machine operating record or log is kept, check to see that it is current and that no entries have been left uncleared, leaving machine in an unsafe condition for operation.

Daily Lubrication

For those items pointed out in the Daily Walk - Around Inspection requiring daily lubrication, refer to the Lubrication Chart for specific requirements.

2.5 DAILY FUNCTIONAL CHECK

WARNING

TO AVOID INJURY DO NOT OPERATE A MACHINE UNTIL ALL MALFUNCTIONS HAVE BEEN CORRECTED. USE OF A MALFUNCTIONING MACHINE IS A SAFETY VIOLATION.

A functional check of all systems should be performed, once the walk-around inspection is complete, in an area free of overhead and ground level obstructions. First, using the ground controls, check all functions controlled by the ground controls. Next, using the platform controls, check all functions controlled by the platform controls.

NOTE: On new machines, those recently overhauled, or after changing hydraulic oil, operate all systems a minimum of two complete cycles and recheck oil level in reservoir.

1. Check Enable Switch for proper operation. Switch must be pressed before activating any functions.

WARNING

TO AVOID SERIOUS INJURY, DO NOT OPERATE MACHINE IF ANY CONTROL LEVERS OR TOGGLE SWITCHES CONTROLLING PLATFORM MOVEMENTS DO NOT RETURN TO THE OFF POSITION WHEN RELEASED.

2. Raise and lower platform several times. Check for smooth elevation and lowering. Check that High Drive cut-out as platform begins to raise.

NOTE: Perform checks from ground controls first, then from platform controls.

3. Drive forward and reverse, check for proper operation.
4. Check that drive brakes hold when machine is driven up a hill, not to exceed rated gradeability, and stopped.
5. Steer left and right. Check for proper operation.
6. Check hydraulic oil reservoir level marks. Refer to Lubrication Chart.
7. Holding the Ground/Platform select switch to Ground. Platform controls should not operate.
8. Place Ground/Platform select switch to off. Platform/ Ground controls should not operate.

2.6 TORQUE REQUIREMENTS

The Torque Chart consists of standard torque values based on bolt diameter and grade, also specifying dry, wet and loctite torque values in accordance with recommended shop practices. This chart is provided as an aid

to the operator in the event he/she notices a condition that requires prompt attention during the walk-around inspection or during operation until the proper service personnel can be notified. The Service and Maintenance section provides specific torque values and periodic maintenance procedures with a listing of individual components. Utilizing this torque chart in conjunction with preventive maintenance section will enhance safety, reliability and performance of the machine.

2.7 BATTERY MAINTENANCE AND CHARGING

⚠ WARNING

TO AVOID INJURY FROM AN EXPLOSION, DO NOT SMOKE OR ALLOW SPARKS OR A FLAME NEAR BATTERY DURING SERVICING.

Battery Maintenance, Quarterly

1. Open battery compartment cover to allow access to battery terminals and vent caps.

⚠ WARNING

WHEN ADDING WATER TO BATTERIES, ADD WATER UNTIL ELECTROLYTE COVERS PLATES. DO NOT CHARGE BATTERIES UNLESS ELECTROLYTE COVERS PLATES.

NOTE: *When adding distilled water to batteries, non-metallic containers and/or funnels must be used.*

To avoid electrolyte overflow, add distilled water to batteries after charging.

When adding water to the battery, fill only to level indicated.

2. Remove all vent caps and inspect electrolyte level of each cell. Electrolyte level should be to the ring approximately one inch from top of battery. Fill batteries with distilled water only. Replace and secure all vent caps.
3. (Remove battery cables from each battery post one at a time, negative first. Clean cables with acid neutralizing solution (e.g. baking soda and water or ammonia) and wire brush. Replace cables and/or cable clamp bolts as required.
4. Clean battery post with wire brush then re-connect cable to post. Coat non-contact surfaces with no-oxid "A" compound, mineral grease or petroleum jelly.
5. When all cables and terminal posts have been cleaned, ensure all cables are properly positioned and do not get pinched. Close battery compartment cover.

6. Start hydraulic system and ensure that it functions properly.

Battery Charging, Daily

NOTE: *To avoid excessive battery charging time, do not allow batteries to become completely discharged.*

To avoid electrolyte overflow, add distilled water to batteries after charging.

When adding water to the battery, fill only to level indicated.

1. Charge batteries at the end of each work day, or when machine performance is significantly reduced due to batteries becoming discharged.
2. Charge batteries in accordance with the following procedure:
 - a. Position the Platform/Ground Select Switch to the off position.
 - b. Open battery compartment, and battery charger compartment covers.

⚠ WARNING

WHEN BATTERY CHARGER IS TO BE USED, CHARGING HARNESS MUST BE PLUGGED INTO A GROUNDED 110 VOLT RECEPTACLE. IF RECEPTACLE IS NOT GROUNDED AND A MALFUNCTION SHOULD OCCUR, THE MACHINE COULD CAUSE SERIOUS ELECTRICAL SHOCK.

- c. Remove charging harness cable and connect to a 220 volt receptacle.
- d. Allow batteries to charge until ammeter on charger, if equipped, is reading zero (0). Normal charging time is 8-10 hours.

NOTE: *When batteries are completely charged, disconnect charging harness cable from receptacle. Store charging harness cable.*

- e. Ensure battery cables are positioned and are not pinched. Close and secure all compartment doors.
3. The battery packs on each side of the frame are designed to be easily removed so that a machine can have two sets of them in order to keep the machine functioning longer. Disconnect the cable quick connects, and remove the two clevis pins on top of the frame. Now, using the forklift pockets under the packs, have a forklift move them to a place where they can be recharged. The new battery packs can be installed by reversing the above procedure.

NOTE: *Battery packs are interchangeable.*

SECTION 2 - PREPARATION AND INSPECTION

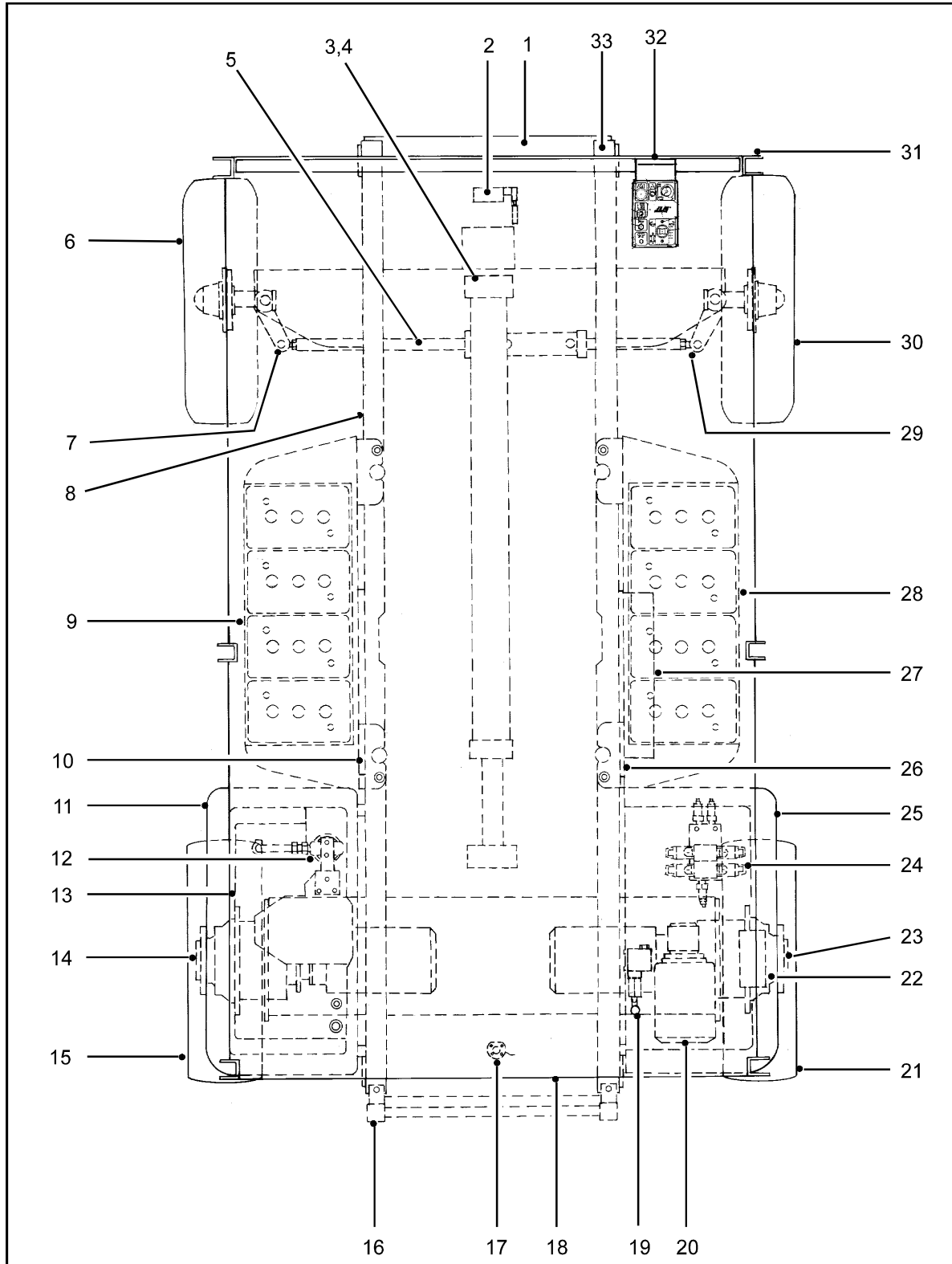


Figure 2-1. Daily Walk-Around Inspection (Sheet 1 of 3)

GENERAL

Begin the "Walk-Around Inspection" at Item 1, as noted on the diagram. Continue Left (counterclockwise viewed from top) checking each item in sequence for the conditions listed in the "Walk-Around Inspection Checklist".

⚠ WARNING

TO AVOID INJURY DO NOT OPERATE MACHINE UNTIL ALL MALFUNCTIONS HAVE BEEN CORRECTED. USE OF A MALFUNCTIONING MACHINE IS A SAFETY VIOLATION.

TO AVOID POSSIBLE INJURY, BE SURE MACHINE POWER IS "OFF" DURING "WALK-AROUND INSPECTION".

NOTE: Do not overlook visual inspection of chassis underside. Checking this area often results in discovery of conditions which could cause extensive machine damage.

1. Battery Charger - No damage, properly secured.
2. Drive Cut-out Limit Switch (3969electric) - Properly secured, no visible damage.
3. High Drive Cut-out Limit Switch - Properly secured, no visible damage.
4. Lift Cylinder - Properly secured, no visible damage, no loose or missing parts, no evidence of leakage.
5. Steer Cylinder - Properly secured, no visible damage, no loose or missing parts, no evidence of leakage.
6. Wheel and Tire Assembly, Left Front - Properly secured, no visible damage, no loose or missing bolts.
7. Spindle and Tie Rod, (left front) - No loose or missing parts, no visible damage, properly secured.
8. Sizzor Arms and Sliding Wear Pads - Properly secured, no visible damage, no loose or missing parts.
9. Battery Installation - Proper electrolyte level, cables secured, no damage or corrosion. Hold-downs secure.
10. Safety Prop - Stored securely, no missing parts, no visible damage.
11. Side Cover, Hydraulic Tank - No loose or missing parts, no visible damage, properly secured.
12. Hydraulic Filter - No visible damage, properly secured, no evidence of leakage.
13. Hydraulic Reservoir - No visible damage or missing parts, no evidence of leaks. Recommended hydraulic fluid level on level indicator on tank. Breather cap secure and working.
14. Drive Hub, Brake and Hub Left Rear - No loose or missing parts, no visible damage, no evidence of leakage.
15. Wheel and Tire Assembly, Left Rear - Properly secured, no visible damage, no loose or missing bolts.
16. Ladder - No damage, securely attached.
17. Tilt Switch - Properly secured, no loose or missing parts, no visible damage.
18. Frame - No visible damage, no loose or missing parts.
19. Manual Descent - No visible damage, properly secured, no evidence of leakage.
20. Motor and Hydraulic Pump - Properly secured, no visible damage, no loose or missing parts, no evidence of leakage.
21. Wheel and Tire Assembly, Right Rear - Properly secured, no visible damage, no loose or missing bolts.
22. Ground Controls - Properly secured, no loose or missing parts, no visible damage. Placards secure and legible, control switches return to neutral position. Control markings legible, manual in manual storage box.
23. Drive Hub, Brake and Hub Right Rear - No loose or missing parts, no visible damage, no evidence of leakage.
24. Control Valve - No loose or missing parts, unsupported wires or hoses, damaged or broken wires.
25. Side Cover, Control Valve - No loose or missing parts, no damage, properly secured.
26. Safety Prop - Stored securely, no missing parts, no visible damage.
27. Controller Cover - No loose or missing parts, no visible damage, properly secured.
28. Battery Installation - Proper electrolyte level, cables secured, no damage or corrosion. Hold-downs secure.
29. Spindle and Tie Rod Assembly (right front)- No loose or missing parts, no visible damage, properly secured.

Figure 2-1. Daily Walk-Around Inspection (Sheet 2 of 3)

SECTION 2 - PREPARATION AND INSPECTION

30. Wheel and Tire Assembly (left front)- Properly secured, no visible damage, no loose or missing parts	damage, placard secure and legible, control lever and switches return to neutral, control lever lock functions properly, emergency stop switch functions properly, control markings legible.
31. Handrails Installation - All railings securely attached, no missing parts, no visible damage, chains in proper working order.	33. Platform Assembly - No loose or missing parts, no visible damage, platform extension operates properly.
32. Control Console - Switches and control lever properly secured, no loose or missing parts, no visible	

Figure 2-1. Daily Walk-Around Inspection (Sheet 3 of 3)

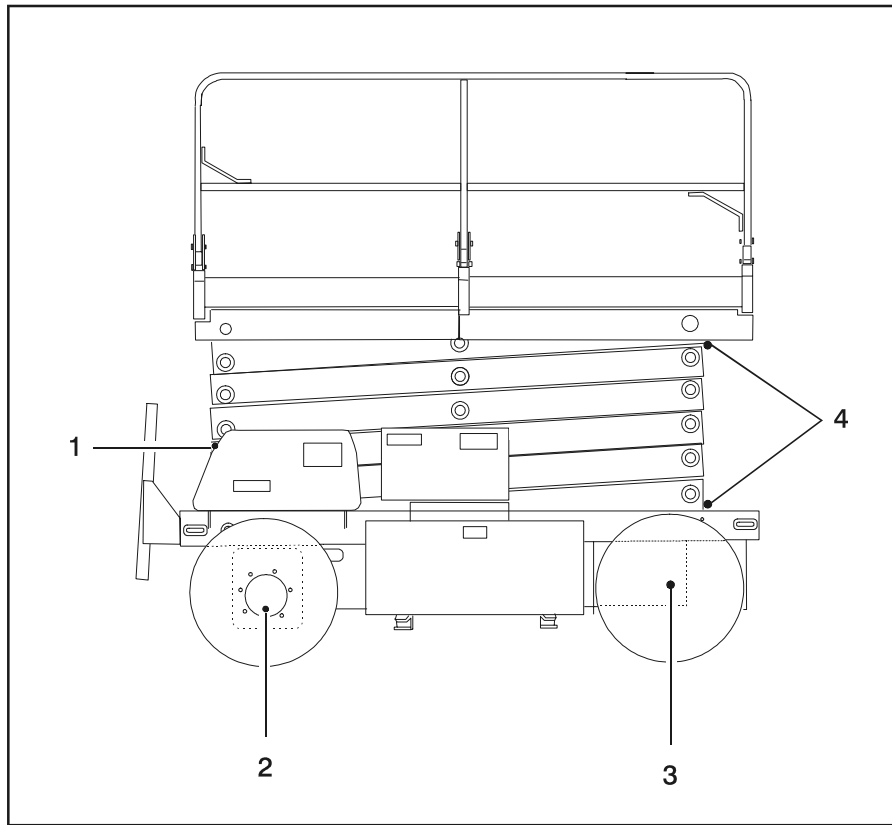


Figure 2-2. Lubrication Diagram

Table 2-1. Lubrication Chart

INDEX NUMBER	COMPONENT	NO/TYPE LUBE POINTS	LUBE/METHOD	INTERVAL HOURS	COMMENTS
1	Hydraulic Oil	Fill Cap/Drain Plug	HO - Kendall Hyken 052	8/800	Check oil every 8 hours of operation Change oil every 800 hours of operation
2	Torque Hub	Fill Plug/Half full	EPGL - SAE 90	2000	Check oil level at side plug on hub
3	Wheel Bearings	Front Wheels	Repack	800	2 years
4	Sliding Wear Pads	8 Wear Pads	Brush	50	N/A
5	Hydraulic Filter Element (not shown)	N/A	Replaceable Element	40/250	Replace filter element after first 40 hours of operation then every 250 hour thereafter

KEY TO LUBRICANTS:
 HO - Hydraulic Oil - Kendall Hyken 052
 EPGL - Extreme Pressure Gear Lube

⚠ WARNING

TO AVOID PERSONAL INJURY, USE SAFETY PROP FOR ALL MAINTENANCE REQUIRING PLATFORM TO BE ELEVATED

NOTE: Be sure to lubricate like items on each side of the machine
 Recommended lubricating intervals are based on machine operations under normal conditions. For machines used in multi-shift operations and/or exposed to hostile environments or conditions, lubricating frequencies must be increased accordingly.

SECTION 2 - PREPARATION AND INSPECTION

SIZE	THD	BOLT DIA. (CM)	THREAD STRESS AREA (SQ. CM)	VALUES FOR ZINC PLATED BOLTS ONLY										UNPLATED CAP SCREWS	
				SAE GRADE 5 BOLTS & GRADE 2 NUTS					SAE GRADE 8 BOLTS & GRADE 8 NUTS					UNBRAKO 1960 SERIES SOCKET HEAD CAP SCREW WITH LOC-WEL PATCH	
				TORQUE		CLAMP LOAD (KG)	TORQUE		CLAMP LOAD (KG)	TORQUE		(DRY OR LOC. 263) NM	(LOCTITE 262) NM	(LOCTITE 242 OR 271) NM	CLAMP LOAD (KG)
4	40	0.2845	0.0153	172	1		1	1		1	245				
4	48	0.0168	0.0168	191	1	1	1	1	272	2	1	1	1	1	1
6	32	0.3505	0.0232	263	2	2	2	2	372	3	2	2	2	2	2
6	40	0.0258	0.0258	277	2	2	2	2	417	3	2	2	2	2	2
8	32	0.4166	0.0356	408	4	3	3	3	572	5	4	4	4	4	4
8	36	0.0374	0.0374	426	4	3	3	3	599	5	4	4	4	4	4
10	24	0.4826	0.0445	508	5	4	4	4	717	7	5	5	5	5	5
10	32	0.0508	0.0508	583	6	4	4	4	817	8	6	6	6	6	6
1/4	20	0.6350	0.0808	916	11	9	9	9	1297	16	12	12	12	12	12
1/4	28	0.0925	0.0925	1052	14	10	10	10	1488	19	14	14	14	14	14
5/16	18	0.7938	0.1331	1515	23	18	18	18	2141	34	25	25	25	25	25
5/16	24	0.1473	0.1473	1678	26	19	19	19	2821	34	27	27	27	27	27
3/8	16	0.9525	0.1969	2241	41	31	31	31	3175	61	48	48	48	48	48
3/8	24	0.2230	0.2230	2540	48	34	34	34	3583	68	48	48	48	48	48
7/16	14	1.1112	0.2700	3085	68	48	48	48	4332	95	75	75	75	75	75
7/16	20	0.3015	0.3015	3425	75	68	68	68	4854	109	81	81	81	81	81
1/2	13	1.2700	0.3604	4105	102	75	75	75	5783	149	109	109	109	109	109
1/2	20	0.4061	0.4061	4854	122	88	88	88	6532	163	122	122	122	122	122
9/16	12	1.4288	0.4623	5262	149	109	109	109	7539	204	149	149	149	149	149
9/16	18	0.5156	0.5156	5874	163	122	122	122	8278	231	176	176	176	176	176
5/8	11	1.5875	0.5740	6532	204	149	149	149	9231	298	231	231	231	231	231
5/8	18	0.6502	0.6502	7394	231	176	176	176	10433	326	244	244	244	244	244
3/4	10	1.9050	0.8484	9662	353	271	271	271	13653	515	380	380	380	380	380
3/4	16	0.9474	0.9474	10796	407	298	298	298	15241	570	434	434	434	434	434
7/8	9	2.2225	1.1735	13336	583	434	434	434	18870	814	624	624	624	624	624
7/8	14	1.2929	1.2929	14697	637	475	475	475	20775	895	678	678	678	678	678
1	8	1.5392	1.5392	17509	868	651	651	651	23360	1220	922	922	922	922	922
1	12	1.6840	1.6840	19142	949	719	719	719	27080	1356	1003	1003	1003	1003	1003
1-1/8	7	2.8575	1.9380	19187	1085	814	814	814	31162	1736	1302	1302	1302	1302	1302
1-1/8	12	2.1742	2.1742	21546	1193	895	895	895	34927	1953	1464	1464	1464	1464	1464
1-1/4	7	3.1750	2.4613	24404	1519	1139	1139	1139	38554	2468	1844	1844	1844	1844	1844
1-1/4	12	2.7254	2.7254	27035	1681	1247	1247	1247	43818	2712	2034	2034	2034	2034	2034
1-1/2	6	3.4925	2.9337	29076	1980	1492	1492	1492	47174	3227	2413	2413	2413	2413	2413
1-1/2	12	3.3401	3.3401	33113	2278	1708	1708	1708	53570	3688	2766	2766	2766	2766	2766
1-1/2	6	3.5687	3.5687	35381	2630	1980	1980	1980	57380	4284	3200	3200	3200	3200	3200
1-1/2	12	4.0132	4.0132	39781	2983	2224	2224	2224	6118	4827	3607	3607	3607	3607	3607

Note: These torque values do not apply to cadmium plated fasteners.



SAE GRADE 5



SAE GRADE 8

Figure 2-3. Torque Chart

SECTION 3. USER RESPONSIBILITIES AND MACHINE CONTROL

3.1 GENERAL

⚠ IMPORTANT

SINCE THE MANUFACTURER HAS NO DIRECT CONTROL OVER MACHINE APPLICATION AND OPERATION, CONFORMANCE WITH GOOD SAFETY PRACTICES IN THESE AREAS IS THE RESPONSIBILITY OF THE USER AND HIS OPERATING PERSONNEL.

This section provides the necessary information needed to understand control functions. Included in this section are the operating characteristics and limitations, and functions and purposes of controls and indicators. It is important that the user read and understand the proper procedures before operating the machine. These procedures will aid in obtaining optimum lift service and safe operation.

3.2 PERSONNEL TRAINING

The sizzor lift is a personnel handling device; therefore, it is essential that it be operated and maintained only by authorized personnel who have demonstrated that they understand the proper use and maintenance of the machine. It is important that all personnel who are assigned to and are responsible for the operation and maintenance of the machine undergo a thorough training program and check out period in order to become familiar with the characteristics prior to operating the machine.

Persons under the influence of drugs or alcohol or who are subject to seizures, dizziness or loss of physical control must not be permitted to operate the machine.

Operator Training

Operator training must include instruction in the following:

1. Use and limitations of the platform controls, ground controls, emergency controls and safety systems.
2. Knowledge and understanding of this manual and of the control markings, instructions and warnings on the machine itself.
3. Knowledge and understanding of all safety work rules of the employer and of Country, Federal, State and local statutes, including training in the recognition and avoidance of potential hazards in the work place; with particular attention to the work to be performed.
4. Proper use of all required personnel safety equipment, in particular the wearing of a fall protection device with a lanyard attached to the platform at all times.

5. Sufficient knowledge of the mechanical operation of the machine to recognize a malfunction or potential malfunction.
6. The safest means to operate near overhead obstructions, other moving equipment, obstacles, depressions, holes, dropoffs, etc. on the supporting surface.
7. Means to avoid the hazards of unprotected electrical conductors.
8. Any other requirements of a specific job or machine application.

Training Supervision

Training must be done under the supervision of a qualified operator or supervisor in an open area free of obstructions until the trainee has developed the ability to safely control a lift in congested work locations.

Operator Responsibility

The operator must be instructed that he has the responsibility and authority to shut down the machine in case of a malfunction or other unsafe condition of either the machine or the job site and to request further information from his supervisor or JLG Distributor before proceeding.

NOTE: *Manufacturer or Distributor will provide qualified persons for training assistance with first unit(s) delivered and thereafter as requested by the user or his personnel.*

3.3 OPERATING CHARACTERISTICS AND LIMITATIONS

General

A thorough knowledge of the operating characteristics and limitations of the machine is always the first requirement for any user, regardless of users experience with similar types of equipment.

Placards

Important points to remember during operation are provided at the control stations by DANGER, WARNING, CAUTION, IMPORTANT and INSTRUCTION placards. This information is placed at various locations for the express purpose of alerting personnel of potential hazards constituted by the operating characteristics and load limitations of the machine. See foreword for definitions of the above placards.

SECTION 3 - USER RESPONSIBILITIES AND MACHINE CONTROL

Capacities

Raising platform above horizontal with or without any load in platform, is based on the following criteria:

1. Machine is positioned on a smooth, firm and level surface.
2. Load is within manufacturers rated design capacity.
3. All machine systems are functioning properly.

Stability

This machine as originally manufactured by JLG when operated within its rated capacity on a smooth, firm and level supporting surface provides a stable aerial platform for all positions.

3.4 CONTROLS AND INDICATORS

Machines are equipped with control panels that use symbols and words to indicate control functions. On some machines, the control panels may use symbols only. Refer to Figure 3-5., Symbols for these symbols and their corresponding functions.

Ground Control Station



ONLY OPERATE FROM THE GROUND CONTROL STATION WITH PERSONNEL IN THE PLATFORM IN AN EMERGENCY. FOR PERFORMING AS MANY PRE-OPERATIONAL CHECKS AND INSPECTIONS FROM GROUND CONTROLS AS POSSIBLE.

NOTE: *When machine is shut down for overnight parking or battery charging, the Emergency Stop switch must be positioned to OFF to prevent draining the batteries.*

1. **ENABLE SWITCH** - On machines built before serial number 020071522 the enable switch must be depressed and released before activating the lift function. A built in timer shuts off power to this function if it is not activated within 3 seconds after the enable switch is released. In addition, this timer will shut off power to the lift function 3 seconds after it is deactivated, making it necessary to depress and release the enable switch before activating lift again. On all machines built after, and including, serial number 020071522 the enable switch must be depressed and held for the duration of lift. The enable switch works in conjunction with the lift switch only.

NOTE: *On machines built before serial 202271522 Holding enable button "IN" while operating lift will cause function to lift very slow.*

2. **PLATFORM/GROUND SELECT SWITCH** - A three position, key operated switch supplies power to platform control console when positioned to platform. With the switch key held in the ground position, power is shut off to platform and only ground controls are operable. When released from ground position the switch spring returns to the (off) position.

NOTE: *With Platform/Ground Select in center position, power is shut off to controls at both operating stations.*

3. **LIFT SWITCH** - A three position, momentary contact lift control switch provides raising and lowering of the platform when positioned to up or down.
4. **HOURMETER** - The hourmeter indicates the number of hours the machine has been operated.
5. **BATTERY INDICATOR AND HOURMETER (If Equipped)** - Provides a visual indication of the condition of the batteries' charge. The hourmeter to indicate the number of hours the machine has been operated.

Platform Control Station

1. **ENABLE SWITCH** - On machines built before serial number 020071522 the enable switch must be depressed and released before activating the drive and lift functions. A built in timer shuts off power to these functions if they are not activated within 3 seconds after the enable switch is released. In addition, this timer will shut off power to the drive and lift functions 3 seconds after they are deactivated, making necessary to depress and release the enable switch before activating drive or lift again. On all machines built after, and including, serial number 020071522 the enable switch must be depressed and held for the duration of lift. The enable switch works in conjunction with the lift switch only.
2. **EMERGENCY STOP** - A two-position red mushroom shaped switch furnishes power to Platform Controls when pulled out (on). When pushed in (off), power is shut down to the platform functions.
3. **TILT ALARM WARNING HORN (If Equipped)** - The tilt alarm warning horn is activated by the tilt alarm switch when the chassis is on a slope (over 1.5 degrees).

NOTE: *TILT ALARM AND WARNING LIGHT (If Equipped) - A red warning light on the control console that lights when the chassis is on a slope (over 1.5 degrees).*

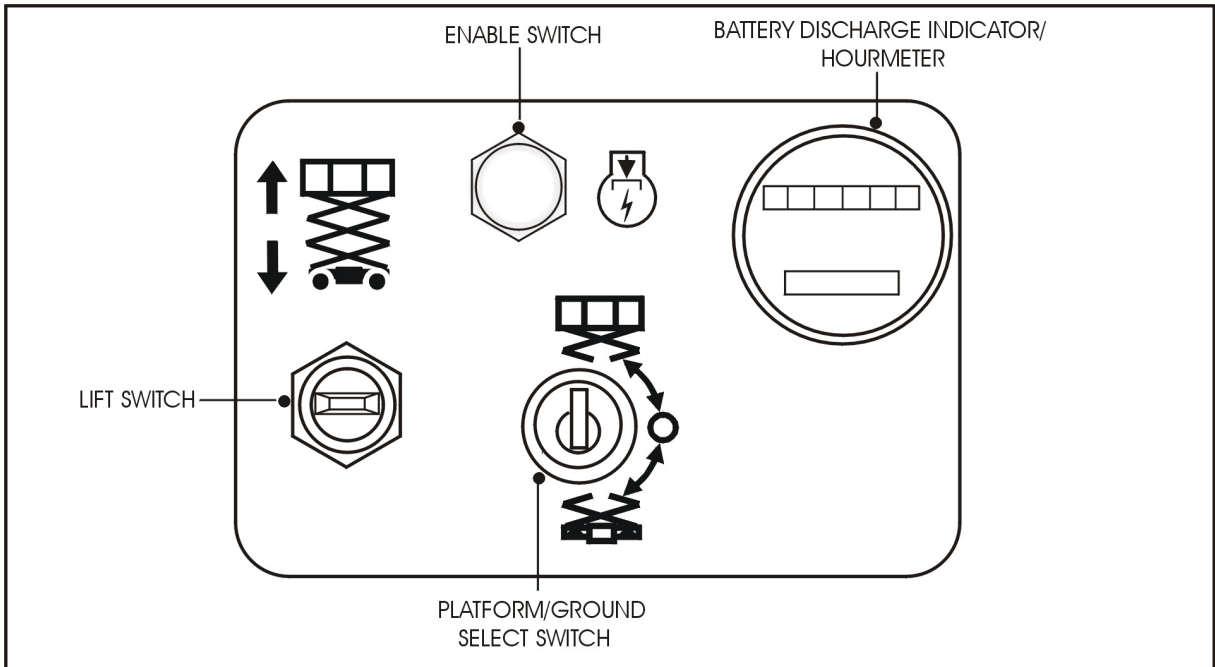


Figure 3-1. Ground Control Station on Machines Before Serial Number 020071522

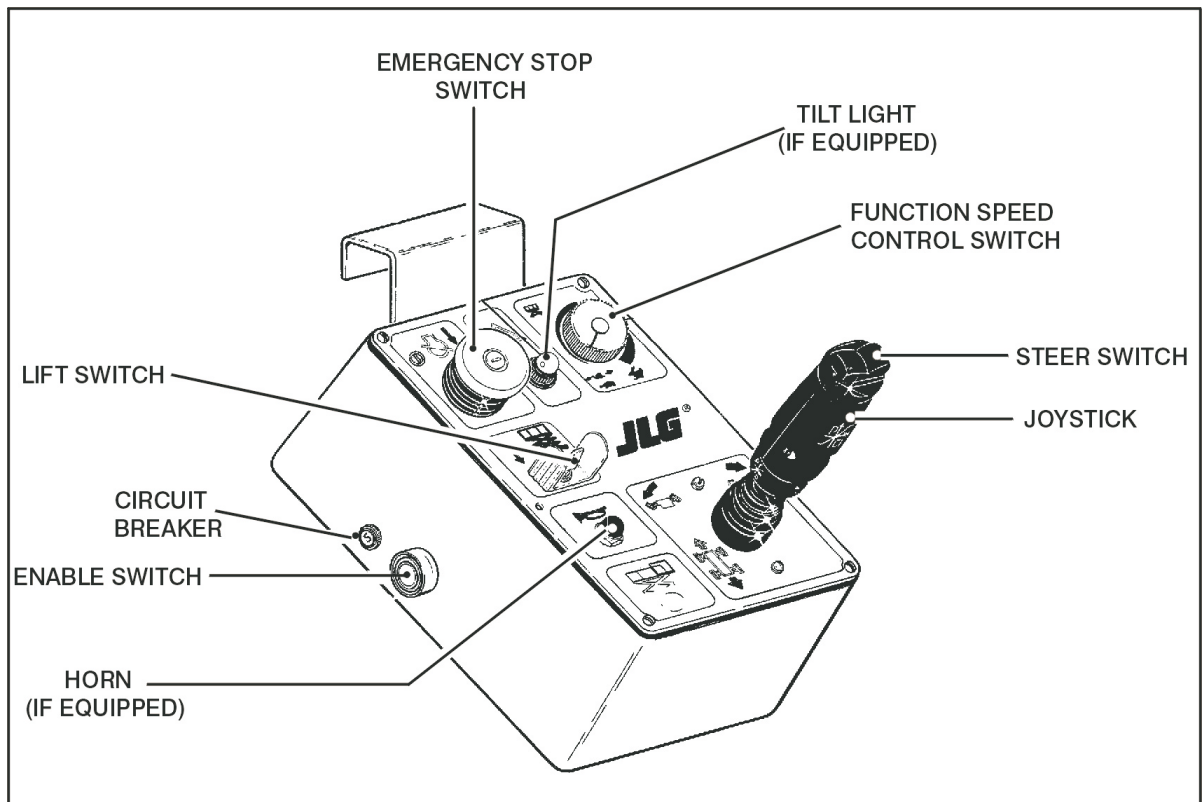


Figure 3-2. Platform Control Station on Machines Before Serial Number 020071522

SECTION 3 - USER RESPONSIBILITIES AND MACHINE CONTROL

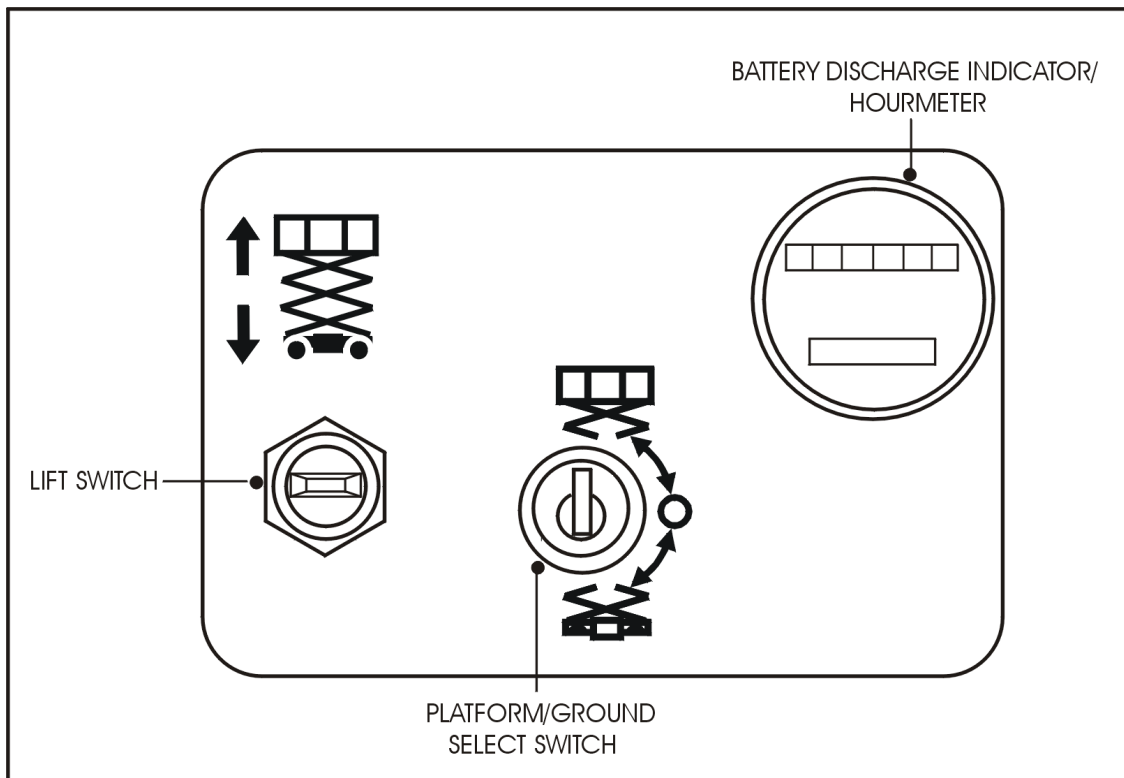


Figure 3-3. Ground Control Station on Machines After and Including Serial Number 020071522

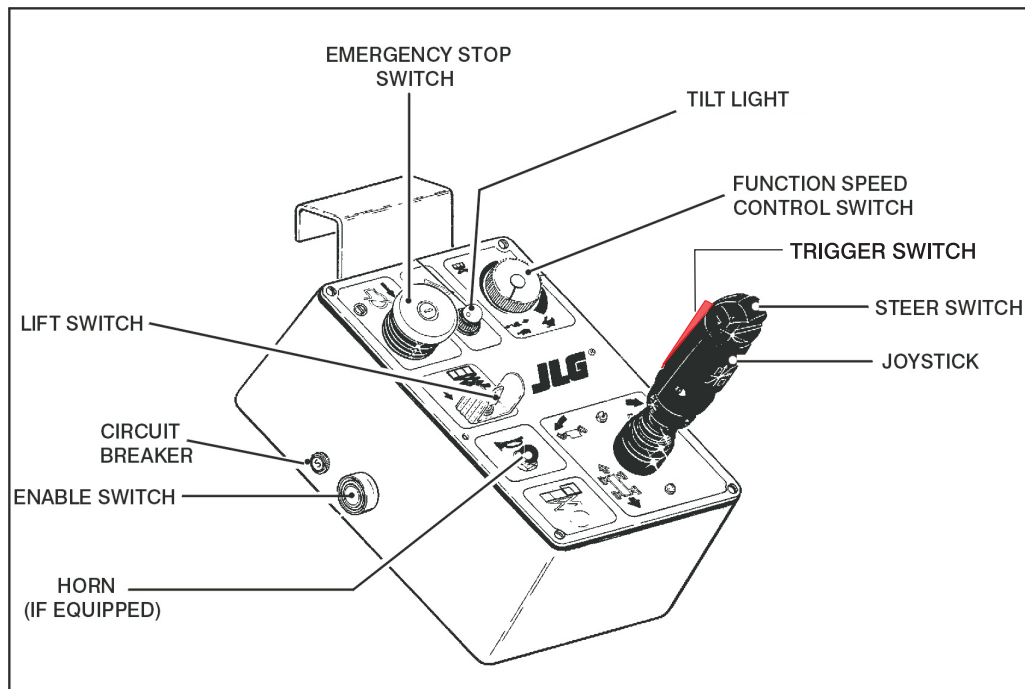


Figure 3-4. Platform Control Station on Machines After and Including Serial Number 020071522

WARNING

IF OPTIONAL TILT ALARM HORN AND WARNING LIGHT IS ACTIVATED WHEN PLATFORM IS RAISED, LOWER PLATFORM COMPLETELY, THEN REPOSITION MACHINE SO THAT IT IS LEVEL BEFORE RAISING PLATFORM.

NOTE: *The drive and steer controller automatically return to the center position when released.*

WARNING

TO AVOID SERIOUS INJURY, DO NOT OPERATE MACHINE IF LIFT, DRIVE, OR STEER SWITCHES DO NOT RETURN TO THE CENTER OFF POSITION WHEN RELEASED.

5. LIFT SWITCH - The lift control switch, when used in conjunction with the enable switch, provides for raising and lowering the platform when positioned to up or down.
6. CONTROLLER (joystick) - The controller performs three function: drive, steer and drive speed. Tilting the controller in the direction you want to go (forward or reverse) activates drive in that direction. The thumb-operated steer switch on top of the controller handle activates the steer wheels in the direction it is moved. Drive speed is determined by distance the controller handle is moved forward or backward.
7. HORN (If Equipped) - This push-button switch, when activated, permits the operator to warn jobsite personnel when the machine is operating in the area.
NOTE: *When Drive or Steer is being operated, Lift will not function.*
8. FUNCTION SPEED CONTROL - This switch allows you to adjust speed of lift and drive functions. Rotate counterclockwise for slower speed and clockwise for faster speed. Adjust drive function to creep. Rotate CCW until the function control knob clicks.
9. TILT LIGHT - This red light illuminates when machine is on a 5 degree or greater tilt. Also, if equipped with the optional alarm, an audible warning will sound if scissor arms are raised.
10. CIRCUIT BREAKER - If the circuit breaker opens (pops out) this indicates a short or overload somewhere on the machine.

SECTION 3 - USER RESPONSIBILITIES AND MACHINE CONTROL


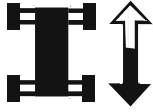

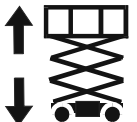

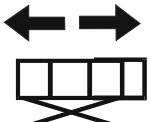

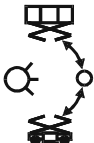

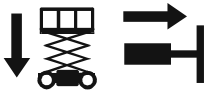

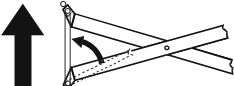



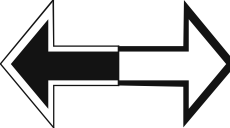
FUNCTION	SYMBOL	FUNCTION	SYMBOL
Power Emergency Stop		Drive	
Chassis Out of Level		Steer	
Platform Up Down		Low Speed Drive	
Deck Extension		High Speed Drive	
Platform/ Ground Select		Fork Lift	
Manual Descent		Manual	
Safety Prop		Hydraulic Oil	
Lifting Area		Tie Down Area	
Directional Arrow			

Figure 3-5. Symbols

SECTION 3 - USER RESPONSIBILITIES AND MACHINE CONTROL

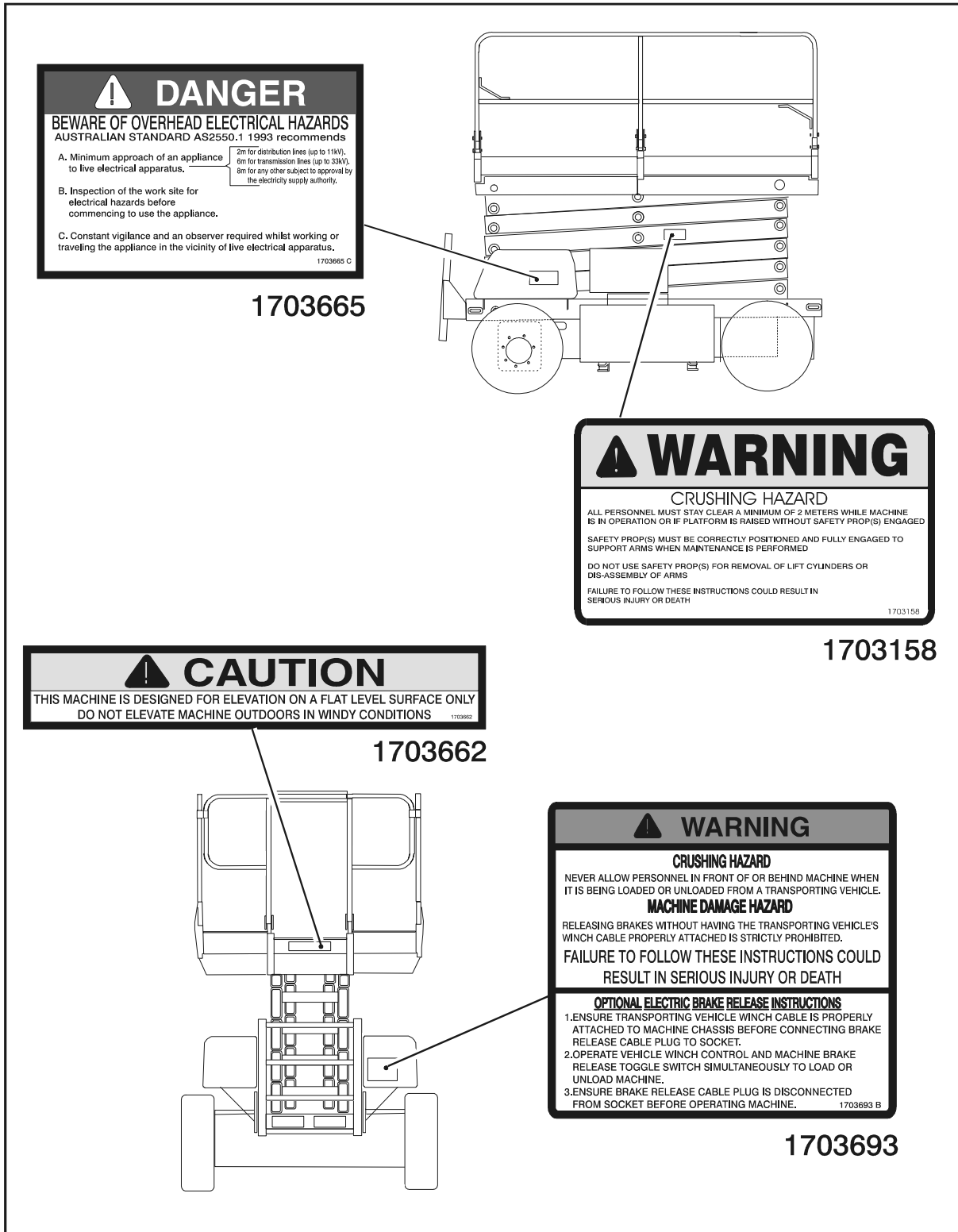


Figure 3-6. Decal Location (Right Side & Rear)

SECTION 3 - USER RESPONSIBILITIES AND MACHINE CONTROL

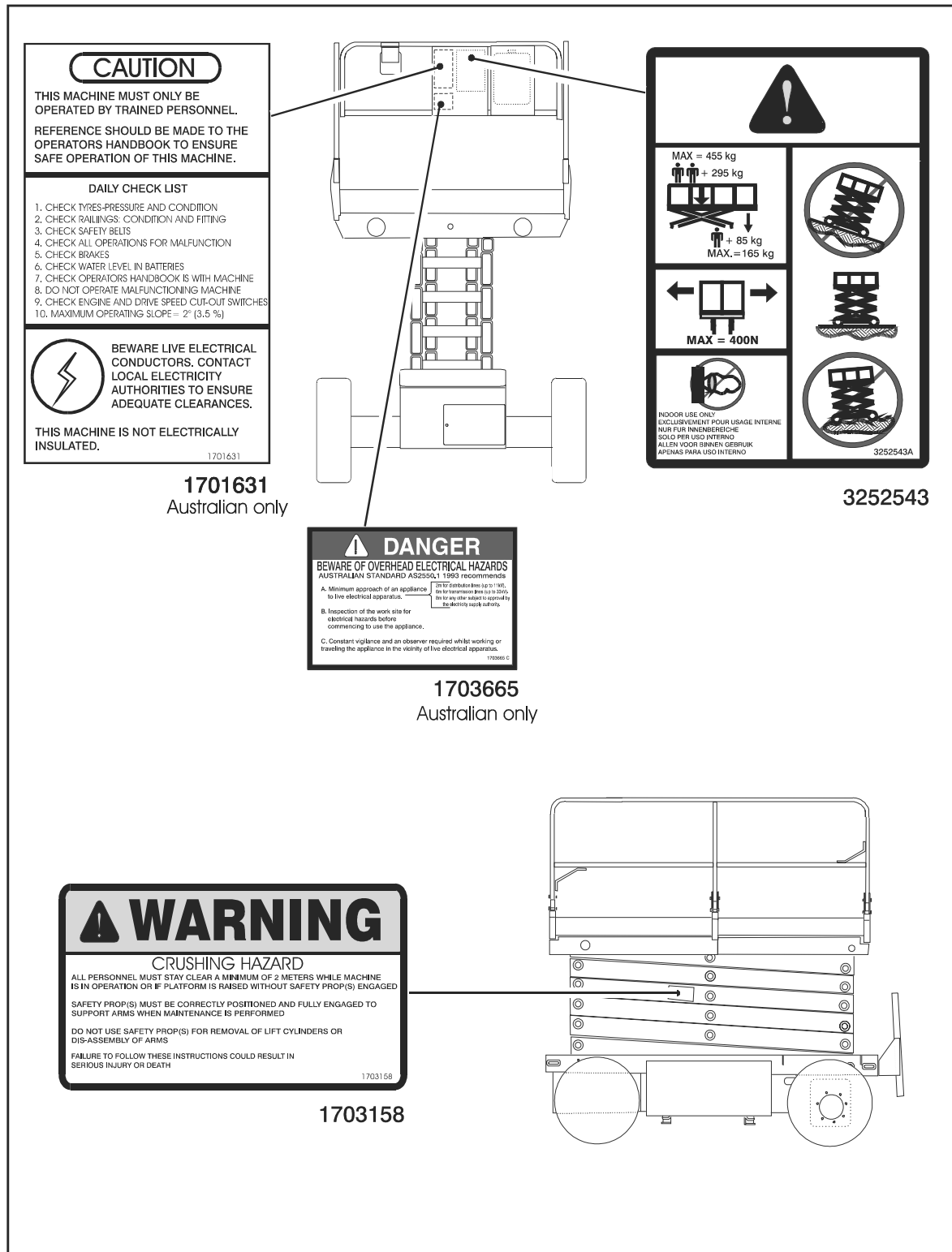


Figure 3-7. Decal Location (Left Side & Front)

SECTION 4. MACHINE OPERATION

4.1 DESCRIPTION

This machine is a self-propelled hydraulic lift equipped with a work platform on the top of an elevating 'sizzor' mechanism. The Sizzor Lift's intended purpose is to position personnel with their tools and supplies at positions above ground level, and can be used to reach work areas located above machinery or equipment positioned at ground level.

The JLG Sizzor has a primary operator Control Station in the platform. From this Control Station, the operator can drive and steer the machine in both forward and reverse directions. The machine has a Ground Control Station which will override the Platform Control Station. Ground Controls operate lift up and down and are to be used in an emergency to lower the platform to the ground should the operator in the platform be unable to do so. Ground Control is also to be used in Pre-Operation check.

Instructions and hazard alerts are posted on to both operator control stations and at other places on the machine. It is extremely important that operators know what instructions and hazard alerts are placed on the machine, and review these periodically so that they are fresh in their minds.

The JLG Sizzor Lift is designed to provide efficient and safe operation when maintained and operated in accordance with warnings on the machine, the Operators & Safety, Service and Specification Manual and all jobsite and government rules and regulations. As with any type of machinery, the operator is very important to efficient and safe operation. It is absolutely necessary that the JLG Sizzor Lift be regularly maintained in accordance with the separate Service and Maintenance Manual, and that any evidence of lack of maintenance, malfunction, excessive wear, damage or modification to the machine be reported immediately to the machine owner or the jobsite supervisor or safety manager and that the machine be taken out of service until all discrepancies are corrected.

The JLG Sizzor Lift is not intended to be used to lift material other than supplies which personnel in the platform require to do their job. Supplies or tools which extend outside the platform are prohibited. It must not be used as a forklift, crane, support for overhead structure, or to push or pull another object.

The JLG Sizzor Lift is powered using a hydraulic pump and cylinders for various functions. The hydraulic components are controlled by electrically activated hydraulic valves using switches and control levers. The speeds of functions controlled by control levers are variable from zero to maximum speed depending upon the position of the function speed control. Functions controlled by toggle switches are either on or off.

The JLG Sizzor is a two wheel drive machine with drive power being supplied by an electric motor at each drive wheel. Each drive wheel is supplied with an electrically released, spring applied brake. These brakes are automatically applied any time the Drive switch is returned to neutral position.

The capacity of the model 3369 electric is 455kg (1000 lb) and the capacity of the model 3969 electric is 340kg (750 lb), uniformly distributed in the center of the platform. This means that the total combined weight of personnel, tools and supplies must not exceed the above figures.

4.2 GENERAL

This section provides the necessary information needed to operate the machine. Included in this section are procedures for traveling, steering, parking, platform loading and transporting. It is important that the user read and understand the proper procedures before operating the machine.

4.3 MOTOR OPERATION

Platform/Ground Select Switch

The Platform/Ground Select switch functions to direct battery power to the desired control station. With the switch held in the ground position battery power is supplied to the ground control station. When the switch is in the platform position, battery power is supplied to the platform control station. When the switch is in the center (off) position, power is cut off from all functions. The switch should be in center (off) position when recharging the batteries or parking the machine overnight.

Motor Activation

With the emergency stop switch pulled out (on), and the power selector switch in the appropriate position, the emergency stop switch in the on position (if operator is at platform controls) depress the enable switch and activate a function switch, the motor becomes activated and operates the desired function.

⚠ CAUTION

IF A MOTOR MALFUNCTION NECESSITATES UNSCHEDULED SHUTDOWN, DETERMINE AND CORRECT CAUSE BEFORE RESUMING ANY OPERATION.

⚠ IMPORTANT

ALWAYS POSITION EMERGENCY STOP SWITCH TO THE 'OFF' POSITION (PUSHED IN) WHEN MACHINE IS NOT IN USE. FAILURE TO DO SO MAY CAUSE UNNECESSARY DRAINAGE OF POWER FROM BATTERIES.

4.4 RAISING AND LOWERING

⚠ WARNING

DO NOT RAISE PLATFORM EXCEPT ON A HARD, LEVEL SURFACE FREE OF OBSTRUCTIONS AND HOLES. ENSURE THAT THERE ARE NO OVERHEAD OBSTRUCTIONS BEFORE RAISING THE PLATFORM.

Raising

1. If machine is shut down, turn Emergency Stop Switch to ON position.
2. Place Power Selector switch to appropriate position.
3. Depress Enable Switch before activating LIFT UP function. Position Lift Switch to UP and hold until desired elevation is achieved.

Lowering

⚠ WARNING

ENSURE SIZZOR ARM AREA IS FREE OF PERSONNEL PRIOR TO LOWERING PLATFORM.

Depress enable switch before activating lift down function. Position lift switch to down and hold until desired elevation is achieved or until platform is fully lowered.

⚠ WARNING

DO NOT 'LIFT DOWN' WITHOUT COMPLETELY RETRACTING OPTIONAL EXTENDING PLATFORM.

4.5 PLATFORM EXTENSION

The machine is equipped with a mechanically extendible deck, which adds 1.22 m (4 ft) to the front of the platform. The deck will move in 15.2 cm (6 in) increments, giving the operator better access to worksites. To extend the deck, lift handle up on the left and right side of the platform to release the latch and use the handle to push the extendible deck out. When the deck reaches the end of its travel, push handle down to latch, this will lock and hold the deck in place. To retract the deck, lift handle up on the left and right side of the platform to release the latch and use the handle to retract deck. Be sure the latch locks the deck in place after it is retracted. Maximum capacity of the deck extension is 227 kg (500 lb).

4.6 PLATFORM HANDRAILS FOLD DOWN PROCEDURE (IN SEQUENCE)

1. Remove the two pins from platform extension gate and fold gate to the left side handrail.
2. After folding gate, remove the pin from extension left side handrail, lift up and fold down handrail onto platform deck.
3. Remove the pin from extension right side handrail, lift up and fold down onto platform deck.
4. Remove the two pins from rear handrail, lift up and fold gate down onto platform deck.
5. Lift up left handrail, fold handrail down onto platform deck.
6. Lift up right handrail, fold handrail down onto platform deck.

4.7 STEERING

To steer machine, the thumb operated steer control switch on the controller handle is positioned to the right for traveling right, or to the left for traveling left. Depress the enable switch before activating the steer function.

When released, the switch will return to the center-off position and the wheels will remain in the previously selected position. To return the wheels to the straightened position, the switch must be activated in the opposite direction until the wheels are centered.

4.8 TRAVELING (DRIVING)

⚠ WARNING

DO NOT DRIVE WITH PLATFORM RAISED EXCEPT ON A SMOOTH, FIRM AND LEVEL SURFACE FREE OF OBSTRUCTIONS AND HOLES.

TO AVOID LOSS OF TRAVEL CONTROL OR UPSET ON GRADES AND SIDE SLOPES, DO NOT DRIVE MACHINE ON GRADES EXCEEDING THOSE SPECIFIED ON WARNING PLACARD AT PLATFORM. DO NOT DRIVE ON SIDESLOPES OVER 5%

TRAVEL GRADES IN "LOW" DRIVE SPEED ONLY. USE EXTREME CAUTION WHEN DRIVING IN REVERSE AND AT ALL TIMES WHEN DRIVING WITH PLATFORM ELEVATED AND ESPECIALLY WHEN DRIVING WITH ANY PART OF MACHINE WITHIN 2 M (6 FT) OF AN OBSTRUCTION.

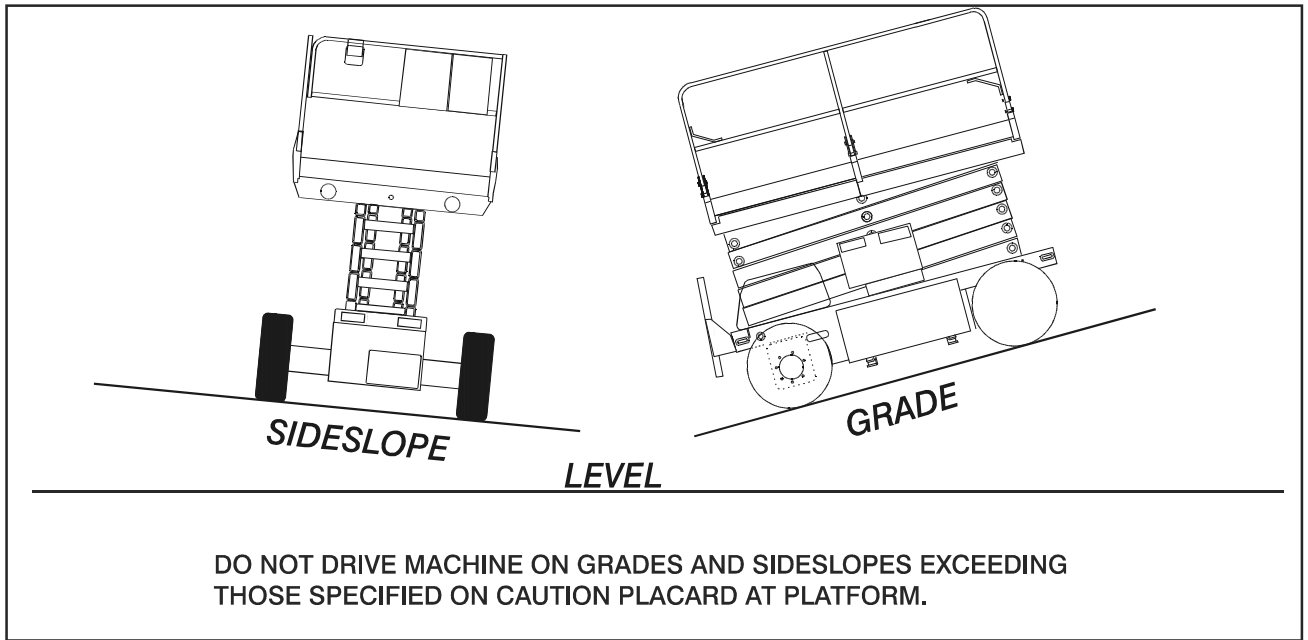


Figure 4-1. Grade and Sideslope

⚠ WARNING

IF HIGH DRIVE SPEED CUT-OUT LIMIT SWITCH MALFUNCTIONS, SHUT DOWN MACHINE AND HAVE AUTHORIZED SERVICE PERSONNEL REPAIR OR REPLACE LIMIT SWITCH PRIOR TO RESUMING OPERATION.

Traveling Forward and Reverse

⚠ IMPORTANT

ENABLE SWITCH MUST BE DEPRESSED PRIOR TO ACTIVATING ANY FUNCTION, OTHERWISE FUNCTION WILL NOT OPERATE.

1. If machine is shut down, turn Platform/Ground Select switch to platform at Ground Control Station.
2. At Platform Controls, pull out Emergency Stop switch and activate Enable switch.
3. Position Drive controller to forward or reverse as desired. Angle of controller will determine travel speed.

4.9 PARKING AND STOWING

NOTE: When parking battery powered units overnight, batteries should be charged in accordance with instructions in Section 2 to ensure readiness for following workday.

To shut down and park the machine, the procedures are as follows:

1. Drive machine to a reasonably well protected area.
2. Ensure platform is fully lowered.
3. Position Platform/Ground Select switch to center off and remove key to disable machine from unauthorized use.
4. If necessary, cover Platform Controls to protect instruction placards, warning decals and operating controls from hostile environment.
5. Chock at least two wheels when parking machine for an extended period of time.

4.10 PLATFORM LOADING

The platform maximum rated load capacity is shown on a placard located on the platform and is based upon the following criteria.

1. Machine is positioned on a smooth, firm and level surface.
2. All braking devices are engaged.
3. Maximum capacity for each model is as follows:

3369 electric - 455 kg (1000 lb)

3969 electric - 340 kg (750 lb)

SECTION 4 - MACHINE OPERATION

4.11 SAFETY PROP

⚠ CAUTION

SAFETY PROP MUST BE USED WHEN MAINTENANCE PERFORMED ON MACHINE REQUIRES SIZZOR ARMS TO BE RAISED.

1. To engage safety prop, raise platform, then rotate prop clockwise until it hangs vertically. Lower the platform until the safety prop rests between the two extended cross-shafts. Maintenance can now begin.
2. To store safety prop, raise platform so that prop can be rotated counterclockwise until it rests on the stop provided on the sizzor arms.

4.12 MACHINE TIE DOWN

When transporting machine, platform must be fully retracted in the stowed mode with machine securely tied down to truck or trailer deck. Four tie down eyes are provided in the frame rail, one at each corner of the machine.

4.13 MACHINE LIFTING

The four slotted holes in the machine frame rails are intended for lifting the machine. When lifting the machine, attach a lifting device to each of the four slotted holes, ensuring that the lifting device's are adjusted to keep the machine level.

NOTE: Crane and lifting devices, chains, slings, etc., must be capable of handling at least:

Model 3369 - 3,856 kg (8,500 lb)

Model 3969 - 4,219 kg (9,300 lb)

⚠ IMPORTANT

THE ABOVE IS A MINIMUM WEIGHT. CHECK WEIGHT OF UNIT PRIOR TO LIFTING.

NOTE: Lifting eyes are provided at the front and rear in the frame rail. Each of the four chains or slings used for lifting machine must be adjusted individually so machine remains level when elevated.

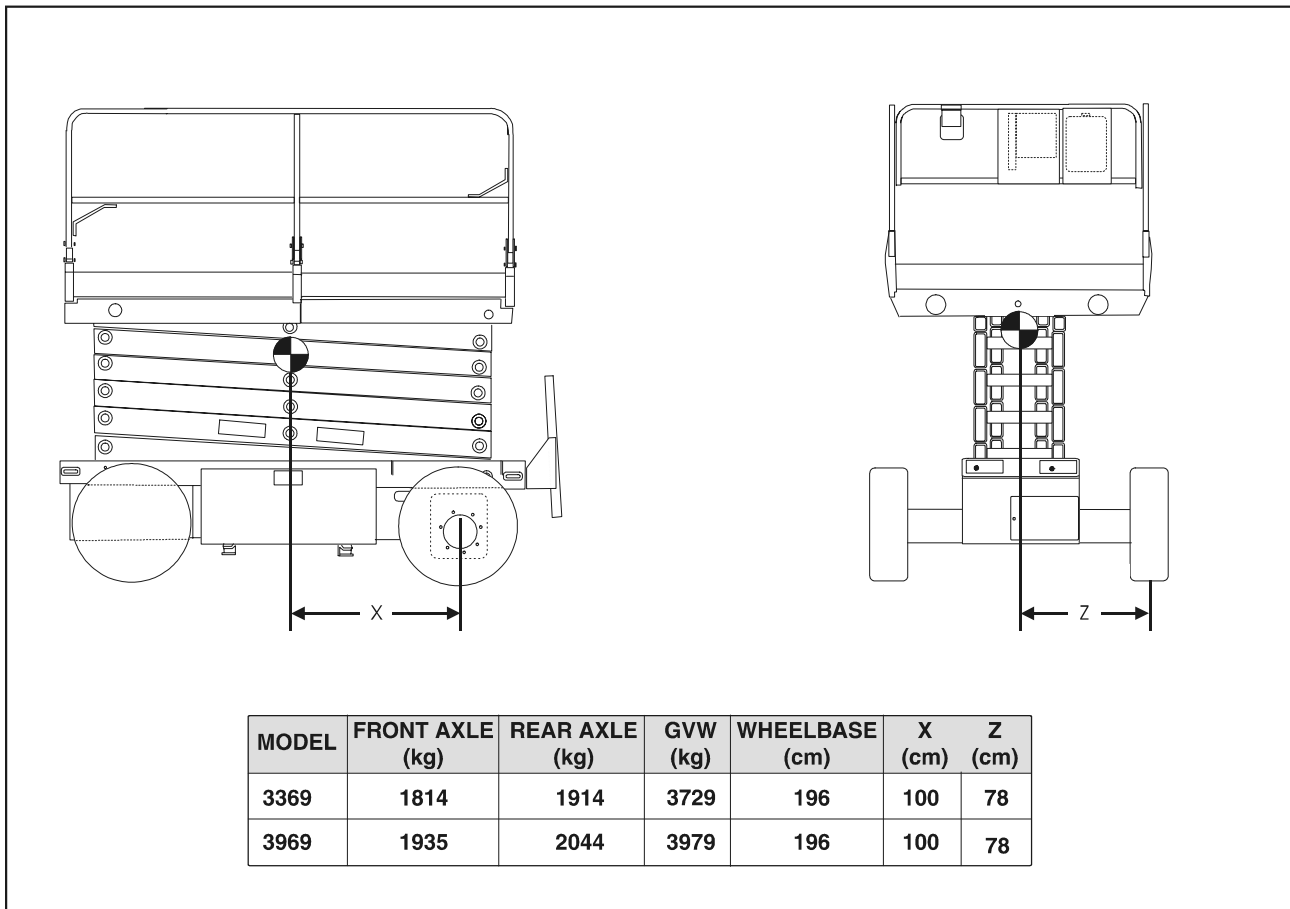


Figure 4-2. Lifting Chart

SECTION 5. OPTIONAL EQUIPMENT

⚠ IMPORTANT

WHEN ADDING AN ELECTRICAL OR ELECTRONIC OPTION TO THE MACHINE, DO NOT GROUND THE DEVICE TO THE MACHINE CHASSIS. AN ELECTRICAL OR ELECTRONIC DEVICE THAT IS GROUNDED TO THE CHASSIS IS SEEN BY THE SEVCON AS A SHORT CIRCUIT AND WILL CAUSE A FAULT CODE TO APPEAR. GROUND ALL ELECTRICAL OR ELECTRONIC DEVICES TO THE APPROPRIATE TERMINAL OF THE SEVCON CONTROLLER.

5.1 BATTERY DISCHARGE INDICATOR

The battery condition indicator is a gauge that provides a visual indication of the condition of the batteries.

5.2 HORN

The warning horn is located on the frame of the machine, and is controlled by a push button switch on the platform control console. The warning horn permits the operator to warn jobsite personnel when the machine is operating in the area.

5.3 TRAVEL ALARM

The motion alarm horn, mounted on the frame of the machine, provides an audible warning when the machine is in the travel (drive) mode. It will function in forward or reverse to warn jobsite personnel the machine is traveling.

5.4 MOTION ALARM

The travel alarm horn, mounted on the frame of the machine, provides an audible warning when the machine is in the drive or lift mode. It will function in forward, reverse, lift up or lift down to warn jobsite personnel the machine is traveling or lifting.

5.5 DESCENT ALARM

Produces an audible warning when platform lift control is placed in the lift down position. The alarm warns personnel in the jobsite area to avoid the sizzor arms.

5.6 TILT ALARM WARNING LIGHT

A red warning light on the control console that lights when the chassis is on a severe slope (over 5 degrees).

5.7 TILT ALARM

An audible warning horn that will sound when the machine is out of level five degrees and illuminates a warning light at the platform control station and sounds the machine's horn, signaling the operator.

5.8 220 VOLT RECEPTACLE

The 220 Volt dual receptacle is mounted on the platform kick rail. The receptacle is connected to a plug on the machine frame which can be connected to a ground receptacle.

5.9 PLATFORM LIGHTS

Platform lights may be installed on the machine platform rails, to provide more lighting for the operator.

5.10 NON-MARKING TIRES

For indoor use, these tires are made from a special compound that, unlike regular tires, will not leave black skid marks on floors and other surfaces.

5.11 ROTATING BEACON PLATFORM/FRAME

An amber rotating beacon may be installed under the platform or on the machine frame, and is activated whenever platform controls are selected at the platform/ground select switch. When activated, the light provides a visual warning of the machine's operation.

5.12 HIGH OUTPUT BATTERIES

For increased operating power and reserve capacity, 370 amp hour batteries are available in place of the standard 245 Amp Hour batteries.

5.13 WHEEL COVERS

Provide protection for wheels and wheel bearings from dirt, grease, mud, rocks, etc.

5.14 CYLINDER BELLOWS

A one piece accordion shaped rubber bellows may be attached to the rod end of the cylinder barrel and the cylinder rod as close to the rod attach bushing as possible. The bellows affords protection to the cylinder rod in either the extended or retracted position. The bellows are installed on the lift cylinders.

This page left blank intentionally.

SECTION 6. EMERGENCY PROCEDURES

6.1 GENERAL

This section provides information on the procedures to be followed and on the systems and controls to be used in the event an emergency situation is encountered during machine operation. Prior to operation of the machine and periodically thereafter, the entire operating manual, including this section, should be reviewed by all personnel whose responsibilities include any work or contact with the machine.

6.2 EMERGENCY TOWING PROCEDURES

Towing this machine is prohibited. However, provisions for moving the machine have been incorporated. The following procedures are to be used **ONLY** for emergency movement to a suitable maintenance area.

1. Chock wheels securely.
2. Engage the mechanical release on both drive brakes by loosening, completely reversing, and tightening the three nuts on each brake.
3. Connect suitable equipment, remove chocks, and move machine.

After moving machine, complete the following procedure:

1. Position machine on a firm level surface.
2. Chock wheels securely.
3. Disengage the mechanical release on both drive brakes by loosening, completely reversing, and tightening the three nuts on each brake.
4. Remove chocks from wheels as desired.

6.3 EMERGENCY CONTROLS AND THEIR LOCATIONS

Emergency Stop Switch

There is red mushroom shaped switch located at the Platform Controls Station. When depressed it will immediately stop all functions at that station and shut down the machine.



WARNING

CHECK DAILY TO MAKE SURE EMERGENCY STOP SWITCH IS FUNCTIONING AND THAT CONTROL INSTRUCTIONS ARE IN PLACE AND LEGIBLE.

Ground Control Station

The Ground Control Station is located on the right side of the frame. The controls on this panel provide the means for overriding the platform controls and for controlling the platform lift up and down from the ground. Place the station SELECT SWITCH in the GROUND position and operate the lift switch to lift up or down.

Manual Descent System

The manual descent system is used, in the event of total power failure, to lower the platform using gravity. To operate the manual descent system, proceed as follows:

1. Turn knob (clockwise) on lowering valve until fully closed.
2. Install handle, and pump until holding valve opens and desired descent speed is attained.
3. When platform is fully lowered, turn knob on lowering valve (counterclockwise) to reopen valve.
4. Return handle to stowed position.

6.4 EMERGENCY OPERATION

Use of Ground Controls

Know how to use Ground Controls in an emergency situation. Ground personnel must be thoroughly familiar with the machine operating characteristics and the ground control functions. Training should include operation of the machine, review and understanding of this section and hands-on operation of the controls in simulated emergencies.

Operator Unable to Control Machine

NOTE: IF THE PLATFORM OPERATOR IS PINNED, TRAPPED OR UNABLE TO OPERATE OR CONTROL MACHINE:

1. Operate the machine from ground controls only with the assistance of other personnel and equipment (cranes, overhead hoists, etc.) as may be required to safely remove the danger or emergency condition.
2. Other qualified personnel on the platform may use the platform controls. **DO NOT CONTINUE OPERATION IF CONTROLS DO NOT FUNCTION PROPERLY.**

3. Cranes, forklift trucks or other equipment which may be available are to be used to remove platform occupants and stabilize motion of the machine in case machine controls are inadequate or malfunction when used.

Platform Caught Overhead

If the platform becomes jammed or snagged in overhead structures or equipment, do not continue operation of the machine from either the platform or the ground until the operator and all personnel are safely moved to a secure location. Only then should an attempt be made to free the platform using any necessary equipment and personnel. Do not operate controls to cause one or more wheels to leave the ground.

Post-Incident Inspection

Following any accident, thoroughly inspect the machine and test all functions first from the ground controls, then from the platform controls. Do not lift above 3 m (10 ft) until you are sure that all damage has been repaired, if required, and that all controls are operating correctly.

6.5 INCIDENT NOTIFICATION

1. It is imperative that JLG Industries, Inc. be notified immediately of any incident involving a JLG product. Even if no injury or property damage is evident, the Product Safety and Reliability Department at 1-877-JLG-SAFE (1-877-554-7233) should be contacted by telephone and provided with all necessary details.
2. It should be noted that failure to notify the Manufacturer of an incident involving a JLG Industries product within 48 hours of such an occurrence may void any warranty consideration on that particular machine.



TRANSFER OF OWNERSHIP

To: JLG, Gradall, Lull and Sky Trak product owner:

If you now own, but ARE NOT the original purchaser of the product covered by this manual, we would like to know who you are. For the purpose of receiving safety-related bulletins, it is very important to keep JLG Industries, Inc. updated with the current ownership of all JLG products. JLG maintains owner information for each JLG product and uses this information in cases where owner notification is necessary.

Please use this form to provide JLG with updated information with regard to the current ownership of JLG Products. Please return completed form to the JLG Product Safety & Reliability Department via facsimile (717) 485-6573 or mail to address as specified on the back of this form.

Thank you,
Product Safety & Reliability Department
JLG Industries, Inc.
1 JLG Drive
McConnellsburg, PA 17233-9533
Telephone: (717) 485-5161
Fax: (717) 485-6573

NOTE: Leased or rented units should not be included on this form.

Mfg. Model: _____

Serial Number: _____

Previous Owner: _____

Address: _____

City: _____ State: _____

Zip: _____ Telephone: (_____) _____

Date Of Transfer: _____

Current Owner: _____

Address: _____

City: _____ State: _____

Zip: _____ Telephone: (_____) _____

Who in your organization should we notify?

Name: _____

Title: _____

Please cut on the dotted line and fax to 717-485-6573





Corporate Office
JLG Industries, Inc.
1 JLG Drive
McConnellsburg PA. 17233-9533
USA
Phone: (717) 485-5161
Customer Support Toll Free: (877) 554-5438
Fax: (717) 485-6417

JLG Worldwide Locations

JLG Industries (Australia)
P.O. Box 5119
11 Bolwarra Road
Port Macquarie
N.S.W. 2444
Australia
Phone: (61) 2 65 811111
Fax: (61) 2 65 810122

JLG Industries (UK)
Unit 12, Southside
Bredbury Park Industrial Estate
Bredbury
Stockport
SK6 2sP
England
Phone: (44) 870 200 7700
Fax: (44) 870 200 7711

JLG Deutschland GmbH
Max Planck Strasse 21
D-27721 Ritterhude/Idpohl
Bei Bremen
Germany
Phone: (49) 421 693 500
Fax: (49) 421 693 5035

JLG Industries (Italia)
Via Po. 22
20010 Pregnana Milanese - MI
Italy
Phone: (39) 02 9359 5210
Fax: (39) 02 9359 5845

JLG Latino Americana Ltda.
Rua Eng. Carlos Stevenson,
80-Suite 71
13092-310 Campinas-SP
Brazil
Phone: (55) 19 3295 0407
Fax: (55) 19 3295 1025

JLG Europe B.V.
Jupiterstraat 234
2132 HJ Foofddorp
The Netherlands
Phone: (31) 23 565 5665
Fax: (31) 23 557 2493

JLG Industries (Norge AS)
Sofeimyrveien 12
N-1412 Sofienyr
Norway
Phone: (47) 6682 2000
Fax: (47) 6682 2001

JLG Polska
Ul. Krolewska
00-060 Warszawa
Poland
Phone: (48) 91 4320 245
Fax: (48) 91 4358 200

JLG Industries (Europe)
Kilmartin Place,
Tannochside Park
Uddingston G71 5PH
Scotland
Phone: (44) 1 698 811005
Fax: (44) 1 698 811055

JLG Industries (Pty) Ltd.
Unit 1, 24 Industrial Complex
Herman Street
Meadowdale
Germiston
South Africa
Phone: (27) 11 453 1334
Fax: (27) 11 453 1342

Plataformas Elevadoras
JLG Iberica, S.L.
Trapadella, 2
P.I. Castellbisbal Sur
08755Castellbisbal
Spain
Phone: (34) 93 77 24700
Fax: (34) 93 77 11762

JLG Industries (Sweden)
Enkopingsvagen 150
Box 704
SE - 175 27 Jarfalla
Sweden
Phone: (46) 8 506 59500
Fax: (46) 8 506 59534
