

# OPERATION MANUAL

---

---

---

## MINI-CRAWLER CRANE

# MC-285C

**SERIAL NO. P00001 AND UP  
(Moment Limiter Type)**

### **⚠ WARNING**

**Unsafe use of this machine may cause serious injury or death. Operators must read this manual before operating this machine. This manual should be kept near the machine for reference and periodically reviewed by all personnel who will come into contact with it.**

### **NOTICE**

**MAEDA has Operation & Maintenance Manuals written in some other languages. If a foreign language manual is necessary, contact your local distributor for availability.**

# M A E D A



# INTRODUCTION

1. Foreword .....	1-2
2. Safety Information .....	1-3
3. Outline of the Machine .....	1-4
4. Qualification for Operating the Machine .....	1-6
5. Glossary .....	1-7

## 1. Foreword

We thank you for selecting Maeda Mini-Crawler Crane NEOX 28C Series.

This manual is the guide book for your safe and efficient use of this machine.

This manual describes procedures for operation and service of this machine as well as matters to be strictly observed while performing them.

Most accidents are attributable to operation, inspection or service where basic safety rules are neglected. Before operating this machine, please read this manual to fully understand the method of operation, inspection and service.

Unless the content of this manual are observed, a serious accident could occur.

### WARNING

**Careless use of this machine may result in serious injury or death.**

**Operator and service personnel should read this manual carefully before starting operation or service of this machine.**

**This manual should be kept in a designated location as a guide , and should be referred to periodically by all the personnel involved.**

- **Do not use this machine unless and until the description in this manual is totally understood.**
- **Always keep this manual ready and convenient for repeated reference.**
- **In case of loss or damage, replace it immediately by ordering from your dealer.**
- **Before transferring this machine, be sure to give this manual to the new owner.**
- **Any descriptions, value or illustrations, are based on the information at the time of publication.**  
**Due to continued improvement on this machine, the service standards, tightening torque, pressure, measuring method, adjust value or illustration are subject to change. Such change may effect the maintenance service work. Before starting your work, contact the supplier to obtain the latest information.**
- **Information regarding safety is provided in Part II "Safety" which starts on herein.**

## 2. Safety Information

For better understanding of this manual and caution plates on the machine, safety related messages are classified as follows:



### **DANGER**

Indicates a pressing danger that may result in death or serious injury. Also indicated is the method to avoid such risk.



### **WARNING**

Indicates a type of danger which is highly probable to result in death or serious injury. Also indicated is the method to avoid such risk.



### **CAUTION**

Indicates any status where it may result in light to medium injury or serious damage to the machine. Also indicated is the method to avoid such risk.

Further, we have shown with following captions what is to be observed for the sake of the machine and what is convenient to know.

### **CAUTION**

Indicates the case where improper handling may cause damage to or shorten the useful life of the machine.

### **NOTES**

Information which is convenient to know.

Rules described in this manual in connection with procedures and safety for operation and service, are applicable only to those cases where this machine is used for designated work.

The manufacturer is not in a position to be able to presume all the cases to which this machine may be exposed by users.

Accordingly, any Rule shown in this manual or on the caution plates affixed to your machine does not cover every situation relevant to safety.

For carrying out any operation or maintenance service not described in this manual, it should be understood that necessary measures for safety are solely for the responsibility of the users.

Even for the responsibility of users, any work or operation expressly prohibited in this manual should never be performed.

### 3. Outline of the Machine

#### 3.1 Designated type of work

This machine should be used mainly for the following work:

- Crane work

This machine is a mobile crane with a boom type crane mounted on rubber tracked undercarriage. It is capable of self propelled movement on job sites and crane work within rated total load. In addition, A remote control system is provided to allow remote control of the crane.

#### 3.2 Configuration of the machine

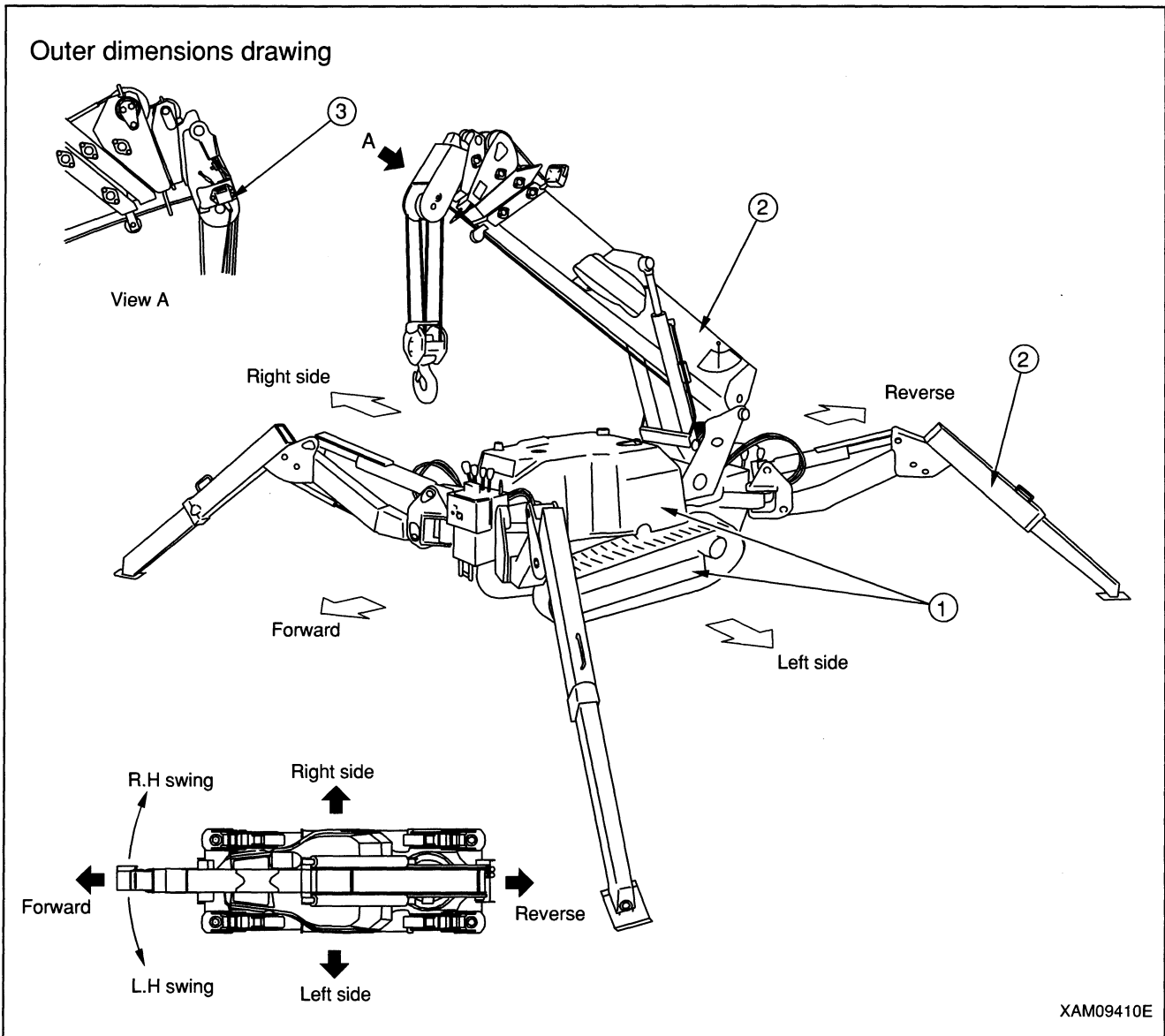

In this manual, front, rear, right and left are in principle identified respectively while viewing forward from the operator position. Above sketch shows the crane in working position.

This machine consists of following major components:

**[1] Undercarriage**

Consists of travel gear, engine, travel control and crane operation systems.

**[2] Crane**

Consists of boom telescoping, boom hoisting, swing and hook-block winches and outrigger systems.

**[3] Safety systems**

Hook over-hoist warning system, hydraulic safety valve, Travel/Crane work selector system (which prevents crane from functioning while traveling) and Tipping over alarm are provided.

### **3.3 Functions this machine is provided with**

**[1] Undercarriage**

- This machine is designed to be more compact with the overall width for travelling reduced from that of our existing models, enabling it to enter tighter spaces.
- Operation with two travel levers allows pivot turn and spin turn in addition to normal operation of forward, backward travel or turning its travel direction.

**[2] Crane**

- Equipped with auto-sliding type outrigger which allows the crane to work over uneven ground or in a tight space. Outriggers can be extended in anyway to match terrain or conditions of a given job site.
- Boom telescoping, hoisting and swinging motions plus vertical move of hook block with winch operation, permits to move suspended load to desired location within rated total weight and working radius.
- Remote control system allows remote control of the outrigger setting and any crane motion.

## 4. Qualification for Operating the Machine

### **WARNING**

- **Workmen's accidents in connection with cranes are occurring frequently. What we would like our users to recognize is the fact that even persons with rich experience are incurring accidents.**
- **For operation of this machine, be sure to observe safety rules shown in this manual.**

### 4.1 Qualification require for Operating cranes

Qualification for operation of this type machine is provided in local laws and regulations. Check with the competent authority or your Meada dealer for detail.



## 5. Glossary

### 5.1 Definitions of words

**[1] Rated total load**

Means the maximum load that can be lifted in accordance with length and angle of the boom. Such load includes mass (weight) of hook and rope.

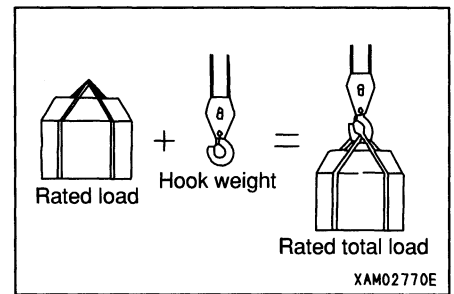

**[2] Rated load**

Means the load with the mass (weight) of hook and rope subtracted from rated total load, which is the load that can be lifted.

**[3] Working radius**

Means the horizontal distance from swing center to hook center.

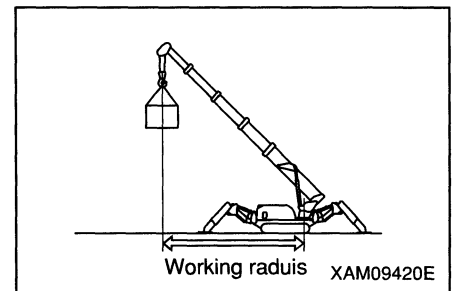

**[4] Boom length**

The distance from boom foot pin to sheave pin of top boom.

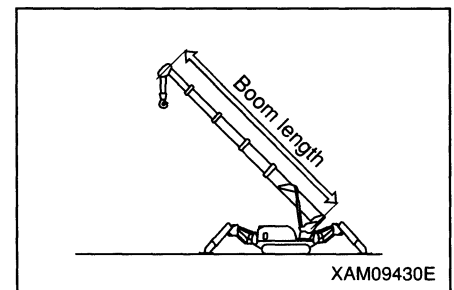

**[5] Boom angle**

The angle made between boom and horizontal ground line.

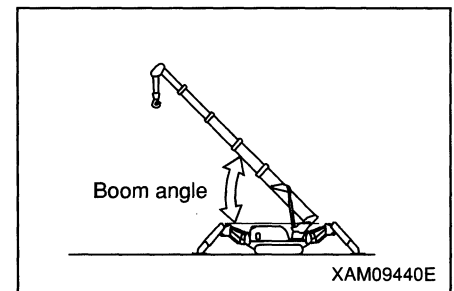

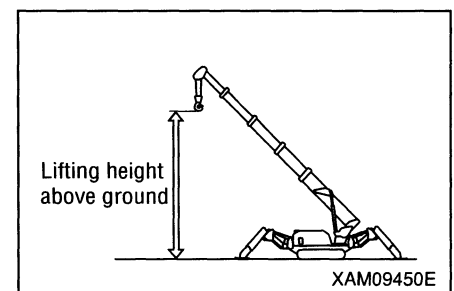

**[6] Lifting height above ground**

Vertical distance from hook bottom to ground with the hook lifted to the maximum (upper limit).



5.2 How to read working radius and lifting height diagram

**! WARNING**

- The working radius/lifting height diagram indicates the relation between the working radius, boom angle and lifting height above ground of this machine, without any load suspended.
- “5.575m Boom” in the working radius/lifting height diagram shows the status where one half of first  mark is extended from the second stage boom.
- “7.075m Boom” in the working radius/lifting height diagram shows the status where one half of second  mark is extended from the second stage boom.

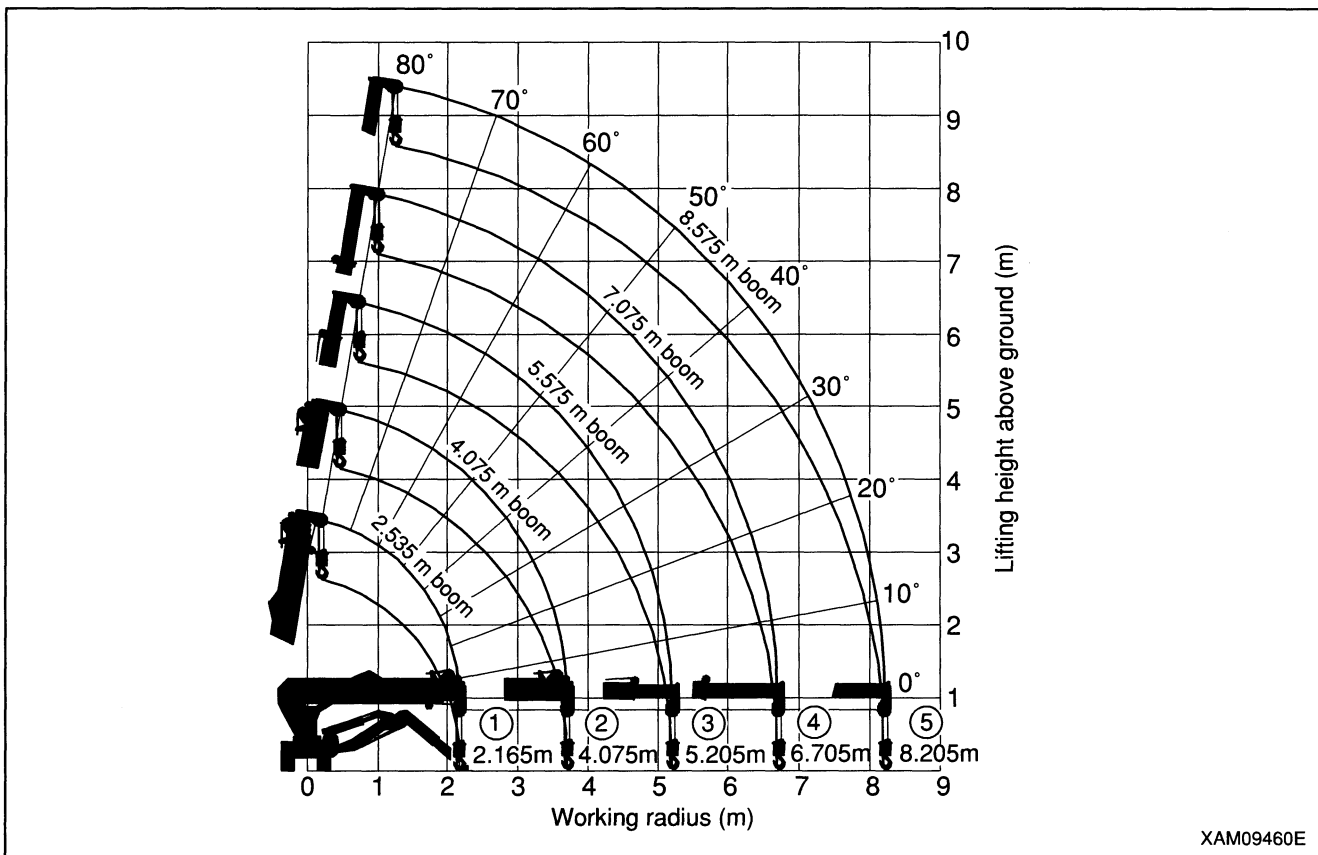

1. Point A in the sketch to the right represents boom angle while point B represents the lifting height above ground. Working radius at points A and B are the same.

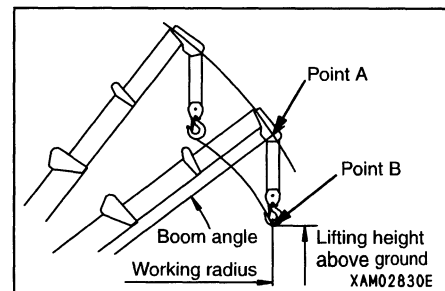

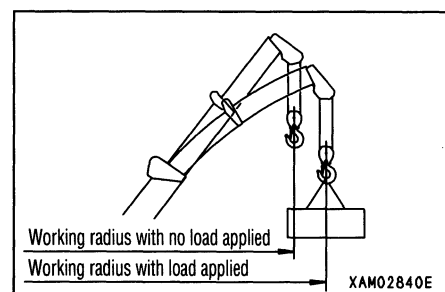

2. “Working radius/Lifting height Diagram” is based on “no-load” without taking into consideration any bending of the boom. In actuality, when load is lifted, the boom will bend causing the working radius to slightly expand. When working radius expands, the value of rated total load will be reduced. It is important that you set your working plan with some room added to the Diagram.



5.3 How to read total rated load chart

**! WARNING**

- Rated total load chart is based on level, hard ground. Depending on the outrigger setting or ground conditions, machine may tip over.
- Rated total load chart is based on working radius with bending of boom and lifted load taken into consideration.
- If boom ③ is extended to any extent, work should be performed within the capacity for “5.575m Boom”.
- When more than one half of the first  mark is exposed from the boom ②, work should be carried out within the performance for the “7.075m Boom”.
- When more than one half of the second  mark is exposed from boom ②, work should be carried out within the performance for the “8.575m Boom”.
- If working radius exceeds the value of Working Radius column in the chart by any extent, work should be performed within the rated total load in the next column of Working Radius.
- Rated total load is shown with the mass of hook (20kg) included.
- Unless outrigger is extended to maximum, work should be performed in accordance with the “Rated Total Load Chart without extending outrigger to maximum”.

MC-285C Rated Total Load Table							
Rated Total Load with Outrigger Extended to Maximum							
2.535m/4.075m boom		5.575m boom		7.075m boom		8.575m boom	
Working radius (m)	Rated Total Load (t)	Working radius (m)	Rated Total Load (t)	Working radius (m)	Rated Total Load (t)	Working radius (m)	Rated Total Load (t)
1.4 below	2.82	3.0 below	1.22	3.6 below	0.82	4.0 below	0.55
1.5	2.52	3.5	0.97	4.0	0.74	4.5	0.4
2.0	1.92	4.0	0.78	4.5	0.58	5.0	0.34
2.5	1.57	4.5	0.63	5.0	0.48	5.5	0.3
3.0	1.22	5.0	0.53	5.5	0.43	6.0	0.27
3.5	0.97	5.205	0.53	6.0	0.38	6.5	0.23
3.705	0.92			6.5	0.35	7.0	0.2
				6.705	0.33	7.5	0.18
						8.0	0.15
						8.205	0.15
Rated Total Load of Outrigger Extended to other than Maximum							
2.535m/4.075m boom		5.575m boom		7.075m boom		8.575m boom	
Working radius (m)	Rated Total Load (t)	Working radius (m)	Rated Total Load (t)	Working radius (m)	Rated Total Load (t)	Working radius (m)	Rated Total Load (t)
1.5 below	1.72	3.0 below	0.51	3.6 below	0.4	4.0 below	0.33
2.0	1.07	3.5	0.41	4.0	0.33	4.5	0.28
2.5	0.63	4.0	0.33	4.5	0.28	5.0	0.23
3.0	0.52	4.5	0.28	5.0	0.23	5.5	0.18
3.5	0.43	5.0	0.23	5.5	0.18	6.0	0.16
3.705	0.35	5.205	0.2	6.0	0.16	6.5	0.15
				6.5	0.15	7.0	0.1
				6.705	0.14	7.5	0.08
						8.0	0.07
						8.205	0.06

XAM11070E

Rated Total Load Chart shows the maximum load the crane is capable of lifting by the working radius, in accordance with boom length and outrigger setting.

**[1] Boom length**

“2.535m Boom”, “4.075m Boom”, “5.575m Boom”, “7.075m Boom” and “8.575m Boom” as appear on top horizontal column of the Rated Total Load Chart represent following cases:

1. “2.535m Boom”: All the booms retracted.

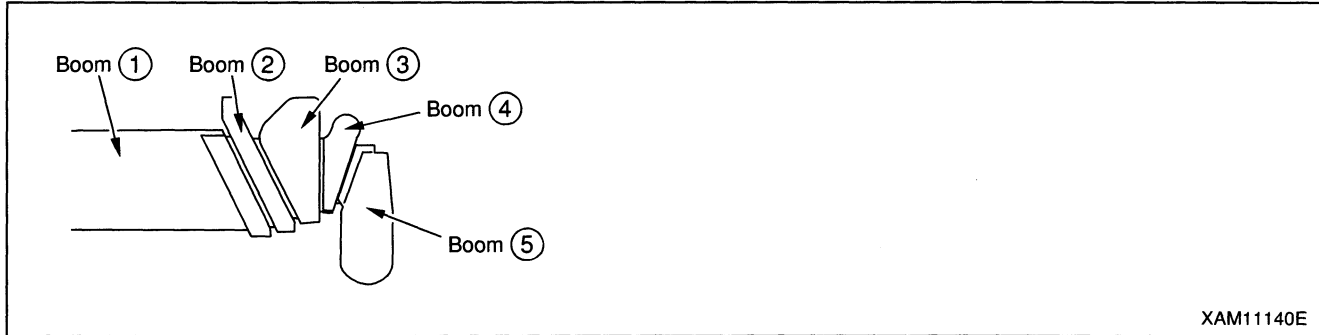

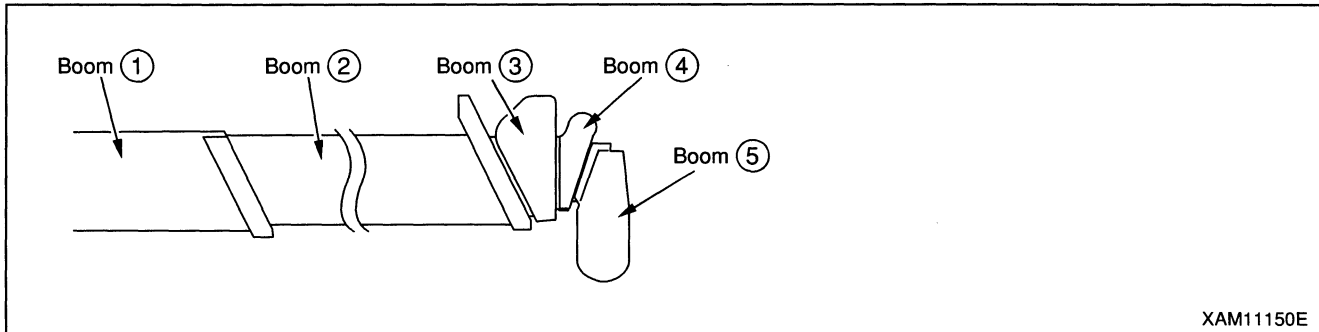

2. “4.075m Boom”: With boom ② extended fully, remainder of booms are all retracted. If boom ② is extended to any extent, work should be carried out on the basis of performance for this configuration.

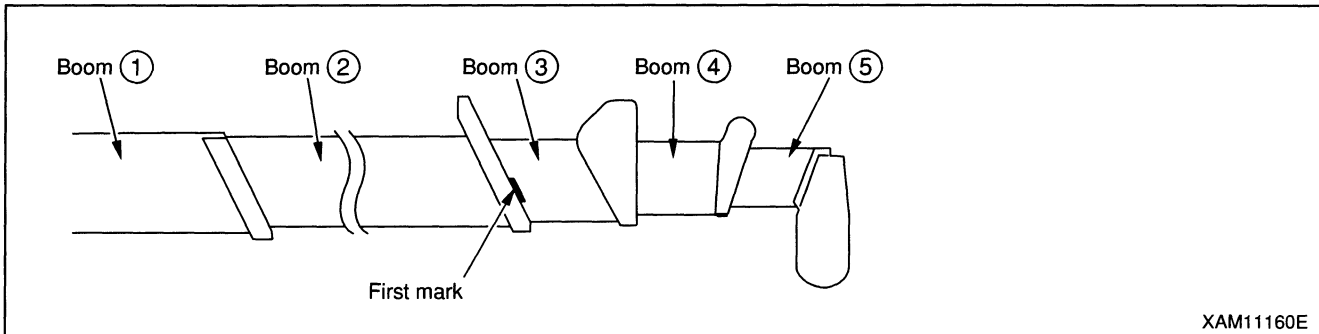

3. “5.575m Boom”: Boom extended to such extent that the first mark of the boom ③ is exposed. When the boom ③ is extended by any amount, however, work should be carried out according to the performance shown in this column.



4. "7.075m Boom": Boom extended to such extent that the second  mark of the boom ③ is exposed. When more than one-half of the first  mark of the boom ③ is exposed, too, your work should be carried out in accordance with the performance of this column.

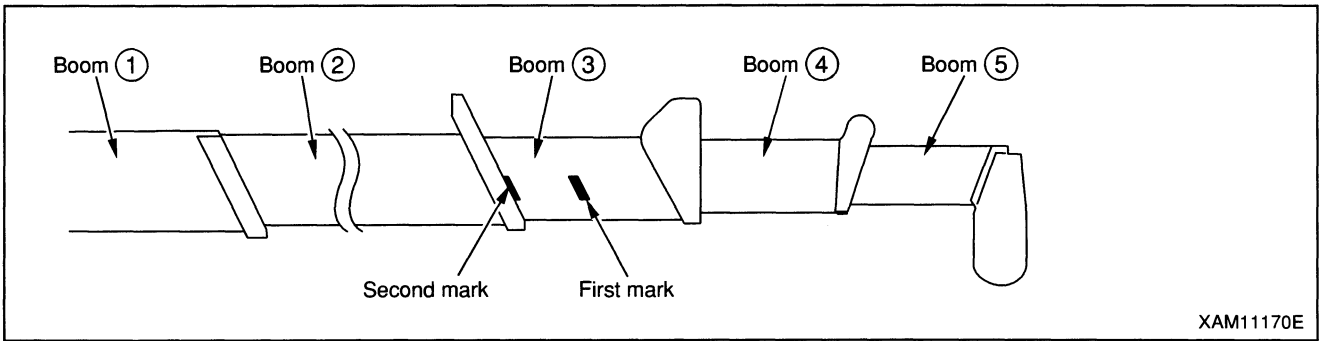

5. "8.575m Boom": All the booms extended fully. When more than one-half of the second  mark of the boom ③ is exposed as well, your work should be carried out in accordance with the performance of this column.

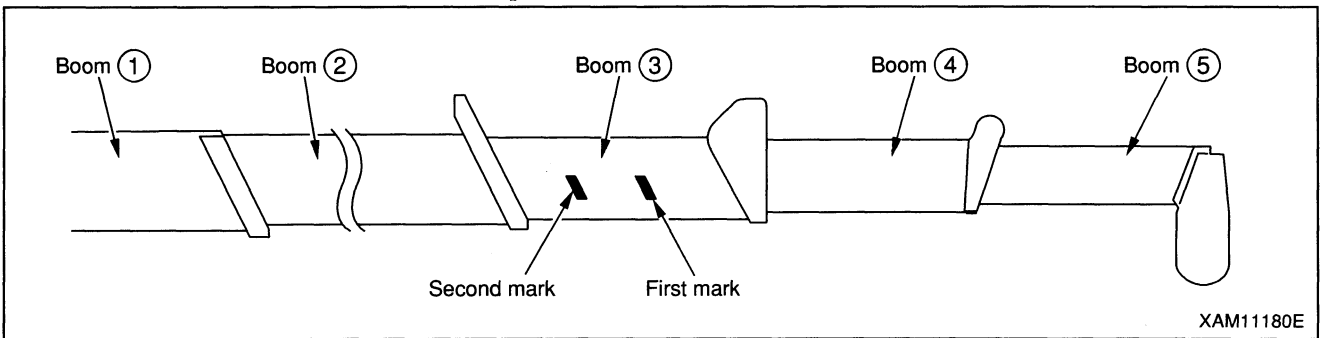

## [2] Outriggers extended to the maximum

**! WARNING**

- For crane work, be sure to extend all the outriggers. Never perform any crane work without setting up outrigger. Machine may tip over causing serious injury otherwise.
- Outriggers should be extended while watching leveling instrument so that the machine is set horizontally.
- Tilting the machine more than three degrees activates alarm buzzer. To stop buzzer, place the machine horizontally.
- For working without extending outrigger to maximum, see the values in “Rated Total Load Chart without extending outrigger to maximum”  
Working under improper value may cause the machine to tip over.
- If you have retracted any positioning pin of outrigger inner box or outrigger base by even one hole, your work should be performed in accordance with the value of “Rated Total Load with Outrigger Extended to other than Maximum”
- Swinging 360 degrees with a load lifted may expose the machine to an unstable position. Reduce the working radius and use sufficient care.

“Outriggers extended to the maximum” at the top of Rated Total Load Chart indicates the status shown in the sketch to the right.

**NOTES**

With the Outrigger extended to maximum” means that, with the outriggers set to the standard extension (60 degrees front and 45 degrees rear), inner boxes of all the outriggers pulled out fully and linkage bracket positioning pins set at the maximum position, the outriggers are placed on level ground.

Any status other than that in the sketch to the right represents “Outrigger Extended to other than Maximum”. See “OPERATION, 2.12 Setting up the outrigger” for proper placement.

**NOTES**

Even with all the outriggers extended to maximum, so long as the grounding surface of any one of them is not flush with bottom surface of track due to uneven terrain or the like, the status will have to be defined as “Outriggers Extended to other than Maximum”.

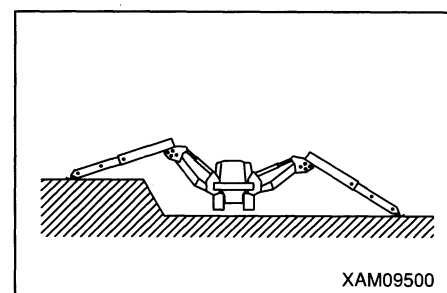
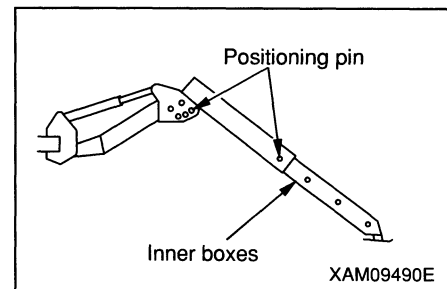
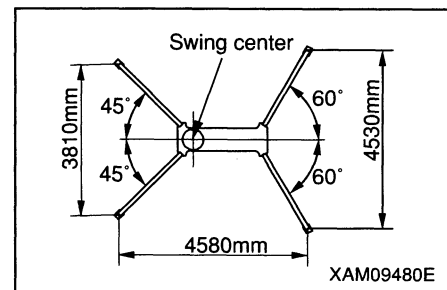

[3] Zones where crane work is prohibited according to the pattern of outrigger placement.

**! WARNING**

- Sketches below indicate the zones where crane work is prohibited according to the pattern of outrigger placement (Shaded area in the sketch). Within such zones, tippingover of machine may take place to result in serious personal accident. Never attempt to perform crane work in such zone.
- Of the 4 outriggers, the pair of either front and rear or right and left should always be set to the standard placement (Front 60 degrees and rear 45 degrees). Even with the two outriggers set to standard placement, the work should be performed in accordance with the value in Total Rated Load Chart with Outriggers Extended to other than Maximum.
- Outrigger placement whereby work is allowed over entire circle, is only in accordance with "Standard Extension" at the center in the sketch below.

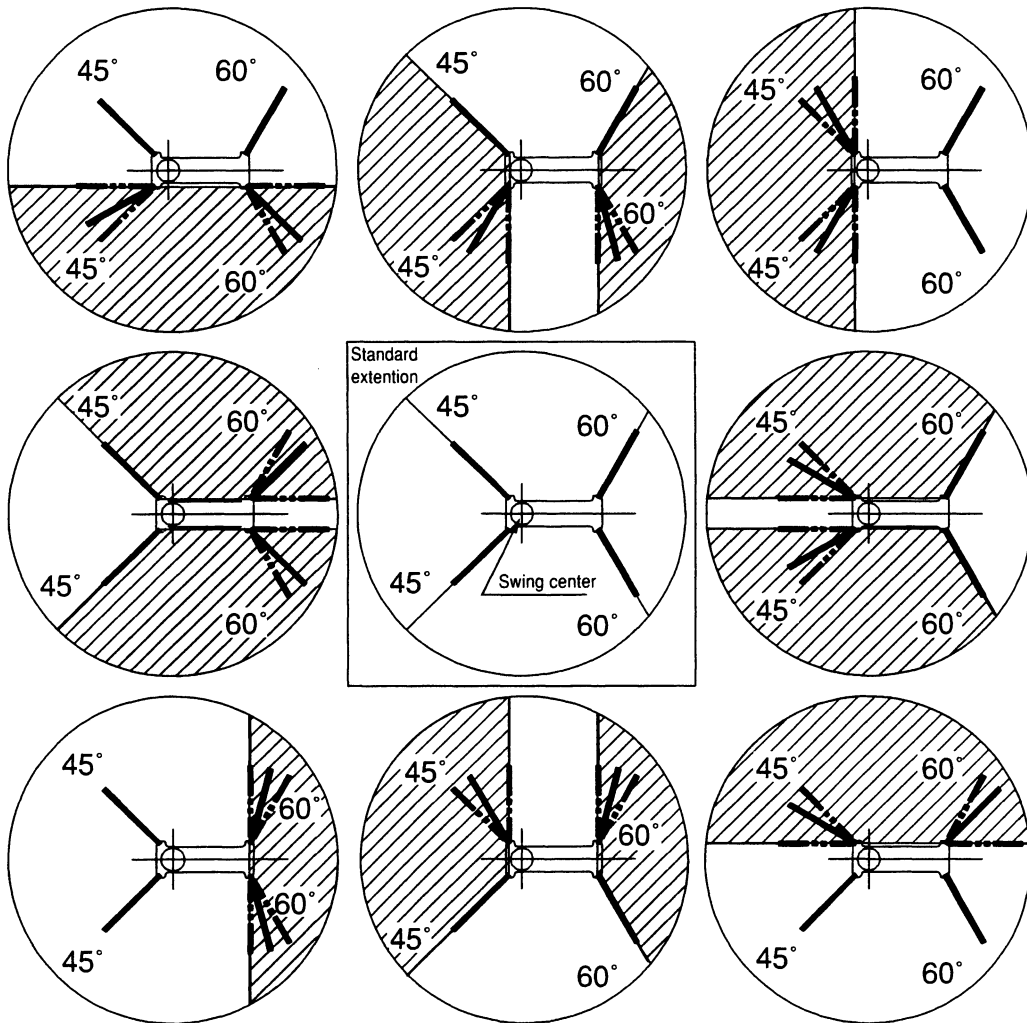

XAM09510E

### 5.4 How to read load indicator ( See also Operation Manual for Moment Limiter )

#### **! WARNING**

- For reading Rated Total Load with load indicator in use, be sure to observe following rules. Serious accident including tipping over and damaging of the crane may be incurred otherwise:
  1. Set up outrigger horizontally over hard ground.
  2. Extend outrigger to the maximum.
 For detail, see "OPERATION, 2.12 Setting up the outrigger".
- Before lifting a load, determine the boom length to be used (number of stages) and boom angle, compare the rated total load at such position indicated by load indicator with the weight of the object and make sure that the total load consisting of the weights of hook, object and rope never exceeds the rated total load.
- When the outrigger is not extended to the maximum, any rated total load value indicated on load indicator is not useful. Read only the boom angle on the load indicator.

Load indicator is affixed to each side of No.1 boom and consists of pointer and scale board as shown in the sketch to the right.

Load indicator indicates the rated total load with outrigger set on hard, level ground and extended to maximum (See Part I Introduction 5.3 [2] Outrigger extended to maximum), excluding bending of the boom. The load indicator should be read in the following manner:

- Read the value at the intersection of curve on scale for the boom in use and pointer. It indicates the Rated Total Load for the boom length in use at the time.

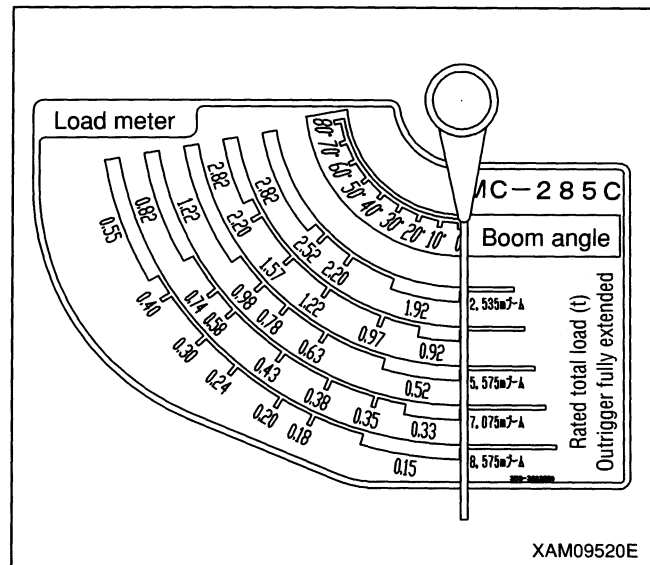



## CONTENTS

### INTRODUCTION

1. Foreword .....	1- 2
2. Safety Information .....	1- 3
3. Outline of the Machine .....	1- 4
3.1 Designated type of work .....	1- 4
3.2 Configuration of the machine .....	1- 4
3.3 Functions this machine is provided with .....	1- 5
4. Qualification for Operating the Machine .....	1- 6
4.1 Qualification require for Operating cranes .....	1- 6
5. Glossary .....	1- 7
5.1 Definitions of words .....	1- 7
5.2 How to read working radius and lifting height diagram .....	1- 8
5.3 How to read total rated load chart .....	1- 9
5.4 How to read load indicator .....	1-14

### SAFETY

1. Basic Rules .....	2- 2
2. Rules for Operation .....	2- 8
2.1 Before starting up engine .....	2- 8
2.2 After the engine has started .....	2- 9
2.3 During crane operation .....	2-13
3. Rules for Transporting a Crane .....	2-21
4. Rules for Handling the Battery .....	2-23
5. Rules to Observe in Connection with Services .....	2-25
5.1 Prior to conducting services .....	2-25
5.2 During service work .....	2-27
6. Location for Affixing Caution Plates .....	2-32

### OPERATION

1. Nomenclature of Components .....	3- 2
1. Nomenclature of Components .....	3- 2
1.2 Nomenclature of travel control components .....	3- 3
1.2.1 Control levers and pedals .....	3- 4
1.2.2 Switches .....	3- 6
1.2.3 Meters and switches .....	3- 7
1.3 Nomenclature of crane control components .....	3- 9
1.3.1 Control levers .....	3-10
1.3.2 Switches .....	3-11
1.3.3 Meters and lamps .....	3-13
1.4 Over-hoist alarm system .....	3-14
1.5 Machinery Cover .....	3-15

2. Operation and Controls .....	3-16
2.1 Before starting engine .....	3-16
2.1.1 Walk-around checks .....	3-16
2.1.2 Checks before starting .....	3-18
2.2 Starting the engine .....	3-37
2.2.1 Starting the engine with main starter switch .....	3-37
2.2.2 Start the engine with main starter switch in cold weather.....	3-38
2.2.2 Starting the engine with auxiliary starter switch .....	3-39
2.3 Operation and checking after engine has started .....	3-40
2.4 Break-in operation .....	3-42
2.5 Travel position of the machine .....	3-42
2.6 Starting the machine .....	3-43
2.7 Change travel direction of the machine.....	3-44
2.8 Stopping and parking the machine .....	3-45
2.9 Stopping the engine .....	3-46
2.10 Inspection and check after stopping the engine. ....	3-46
2.11 Rules for travelling.....	3-47
2.12 Setting up the outrigger .....	3-48
2.13 Matters to be known before starting crane work .....	3-53
2.14 Operations prior to starting crane work .....	3-54
2.15 Crane work position .....	3-55
2.16 Hoisting and lowering operation .....	3-56
2.17 Boom hoisting and lowering operation .....	3-56
2.18 Boom telescoping operation .....	3-57
2.19 Swing operation .....	3-58
2.20 Accelerator pedal operation.....	3-59
2.21 How to use load indicator and load meter .....	3-60
2.22 Stowing the crane .....	3-63
2.23 Stowing the outrigger .....	3-64
2.24 Matters prohibited in connection with crane operation .....	3-67
3. Handling of Rubber Track.....	3-69
3.1 Smart way of using it .....	3-69
3.2 Warranty .....	3-69
3.3 Prohibited types of work .....	3-70
3.4 Rule for using it .....	3-71
4. Handling of Wire Rope .....	3-73
4.1 Standard for wire rope replacement.....	3-73
4.2 Measures to take when winch wire rope is twisted.....	3-74
5. Transport.....	3-75
5.1 Loading and unloading.....	3-75
5.2 How to lift the machine .....	3-76
5.3 Rules for loading.....	3-77
5.4 Rule for transport .....	3-77
6. Handling in Cold Climate.....	3-78
6.1 Preparation for low ambient temperature .....	3-78

7. Long Term Storage .....	3-80
7.1 Treatment prior to storage .....	3-80
7.2 During storage .....	3-80
7.3 After storage .....	3-80
8. Handling of Battery .....	3-81
8.1 Rules for handling the battery .....	3-81
8.2 Removal and installation the battery .....	3-82
8.3 Rules for charging the battery .....	3-82
8.4 Starting with booster cables in use .....	3-83
9. Measures to be Taken in Case of Abnormality .....	3-85
9.1 In connection with electrical components .....	3-85
9.2 In connection with the machine .....	3-85
9.3 In connection with engine .....	3-86

## MAINTENANCE

1. Rules for Conducting Service .....	4- 2
2. Basics of Service .....	4- 4
3. Legally Required Inspection .....	4- 6
3.1 Safety regulation on crane .....	4- 6
4. Consumable Parts .....	4- 7
5. Lubrication Oil and Grease .....	4- 8
5.1 Applicable lubricants by ambient temperature .....	4- 8
6. Standard Tools and Standard Tightening Torque .....	4- 9
6.1 Inquiry on standard tools .....	4- 9
6.2 List of standard tightening torque .....	4- 9
7. Maintenance Schedule Chart .....	4-12
8. Service Procedure .....	4-14
8.1 Initial 10 hours service .....	4-14
8.2 Initial 50 hours service .....	4-14
8.3 Initial 250 hours service .....	4-14
8.4 When required .....	4-15
8.5 Checks before starting .....	4-21
8.6 Every 30 hours service .....	4-40
8.7 Every 50 hours service .....	4-42
8.8 Every 100 hours service .....	4-45
8.9 Every 250 hours service .....	4-46
8.10 Every 500 hours service .....	4-48
8.11 Every 1000 hours service .....	4-55
8.12 Every 2000 hours service .....	4-65

## SPECIFICATION

1. Main data and specifications .....	5- 2
1.1 Specifications chart .....	5- 2
1.2 Dimension drawing .....	5- 3
1.3 Rated total road table.....	5- 4
1.4 Working radius – lifting height chart .....	5- 4

# SAFETY

- 1. Basic Rules ..... 2- 2
- 2. Rules for Operation ..... 2- 8
- 3. Rules for Transporting a Crane ..... 2-21
- 4. Rules for Handling the Battery ..... 2-23
- 5. Rules to Observe in Connection with Services ..... 2-25
- 6. Location for Affixing Caution Plates ..... 2-32

 **WARNING**

**Read and observe these safety related rules thoroughly. Violating this manual can result in an accident involving serious injury or death.**

# 1. Basic Rules

## Follow the instruction161 manual and caution plates.

- Read and understand this manual and caution plates affixed to the machine. Operating the machine without fully understanding them may lead to improper operation resulting in an accident involving personal injury or damage to the machine.
- Understand proper method of using and servicing this machine to perform operation safely.
- This manual and caution plates on the machine should always be kept legible. When they become illegible, replace them quickly by obtaining from your dealer.

For example

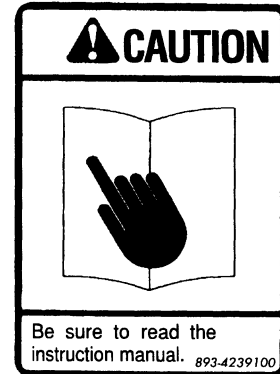

## Qualification to operate

- Official qualification may be required to operate this machine.
  - ★ See “FOREWORD, 4. Qualification for operation” in this manual for detail.
- Operation of this machine normally requires certain official qualifications for mobile crane or small sized mobile crane as well as for performing slinging work. Check with your local authority for required qualifications
- Operator should receive sufficient training and acquire sufficient operating technique before starting to operate the crane.

## Protective items and clothing

- Be sure to wear hard hat, safety shoes and safety belt.
- Select personal protective items that conform to the PPE instruction, suitable to respective working conditions and be sure to wear them.
- Do not wear excessively large clothing or accessory which may be caught by control lever or other projection, causing the machine to make unintended movement.

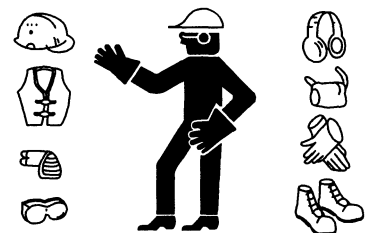

A0055010

**Rules for safe operation**

- Follow instruction or signal of management and leader, to work with priority placed on safety.
- Work while observing the basics of crane work.
- Be sure to conduct prescribed inspection before starting operation and work.
- Do not work under weather conditions of gale, thunder or fog.
- When excessively tired, drunk, or taking hypnagogue or any drugs affecting work, never operate the machine.
- For performing operation, inspection or service, be sure to observe working rules, safety regulations and operating procedures.
- Pay attention to surroundings and pedestrians when working. When a pedestrian carelessly approaches, suspend your work and take measures to give warning.
- Always be alert while operating the machine against unexpected happenings and be ready to address them.
- Never operate the machine beyond its performance or application specified in this manual.
- Be sure to observe prescribed rated total load and working range.
- Never operate the machine looking aside, recklessly or forcibly.

**Before operating a machine that has been leased to or driven by others:**

Before operating any machine which has been on rental or use by others, make sure of the following in writing. Check the past services including voluntary periodical inspection, based on the inspection record as well:

- (1) Crane capacity
- (2) How the crane has been serviced
- (3) Habit or weakness of the particular crane
- (4) Miscellaneous matters to be watched in connection with operation.
  - (a) Function of brake and clutch
  - (b) Availability and function of flood light, rotational light, etc.
  - (c) Function of hook, winch, outriggers etc.

**Provision for safety protections**

- Make sure that all the guards and covers are properly in place and if not, be sure to correct promptly.
- Use safety systems properly after fully understanding their usage.
- Never remove safety systems and always maintain them to function properly.
- Incorrect use of safety system may result in a serious accident.

**Follow the instruction and signal to work.**

- For a work using the crane, select a work leader, and implement the work under responsibility of the work leader.
- Do not work together with two cranes or more.
- Crane work by nature contains the risk of causing worker's arm or finger to be caught between boom and undercarriage or clearance of moving parts of boom derrick cylinder. Operator should make certain that there is no person inside the working radius.

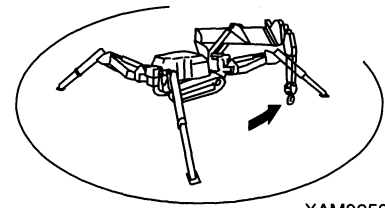

XAM09530



A0055130

**For prevention of trouble**

- Always conduct inspection and service carefully to prevent trouble from developing.
- If any abnormality is felt with respect to your machine, suspend the work immediately and report to a superintendent.
- With respect to the countermeasures to prevent consequential disaster, have the sharing of duties established beforehand.
- When any fuel or hydraulic oil is leaking from the machine, do not operate it but report to a superintendent and eliminate such leakage completely before continuing the work.

This machine uses diesel fuel as its fuel. Pay particular attention to any fuel leakage.

- Before leaving the machine, ground any lifted load, shutdown engine and remove the engine key.

However, do otherwise in case involving possible danger risking lives.



A0055020

**Temporary storage of troubled machine**

For temporary storage of troubled machine waiting for service, let everyone on the job site know that the use of machine is prohibited in the following manner.

- Post the prohibition conspicuously, with outline of trouble, personnel to contact and time limit for storage indicated.
- For parking such machine, apply chocks to rubber track for prevention of rolling.
- Remove the starter key and have it kept by the person responsible to keeping it.



### Provision of fire extinguisher and first aid kit

Be sure to observe following in preparation for unexpected injury or fire:

- Have fire extinguisher installed at designated location and its instruction label read by everyone for ready use in emergency.
- Determine the location to keep first aid kit. It should be periodically checked and replenished as required.
- Have measures against and procedures for injury or fire established beforehand
- Have procedures for notifying an emergency contact (doctor, ambulance, fire station) established and displayed conspicuously so anyone at the site can act properly.

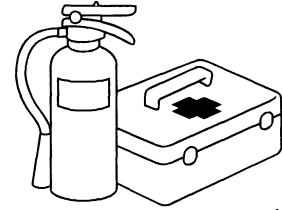

A0055070

### Work reasonably and carefully

- Abrupt lever operation and jerky machine operation should be avoided.
- When two or more cranes are closely positioned to work, operate them carefully, paying attention to avoid tipping over due to contact. Place a guide as necessary for prevention of such contact.
- When you notice any trouble or danger, discontinue the work immediately to avoid the risk.
- Discontinue your work under bad weather (heavy rain, gale, thunder or dense fog). Such judgment should be made in accordance with "Standard for discontinuing work" as well as judgment of leader.

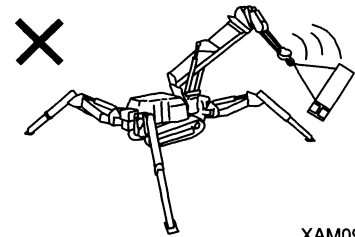

XAM09540

### Do not make modification

Do not make any modification to your machine without our written consent. Any modification involves an issue of safety and should be discussed with our service personnel. We can not be responsible for any injury or other trouble due to modification without our consent.

### Safety during refueling

- This machine operates using diesel fuel. Make sure to use fuel of proper type. Wrong fuel will cause damage to engine.
- Be sure to shutdown engine for refueling. Refueling with engine running may cause inflammation of spilled fuel at heated muffler.
- Over-refueling is dangerous with spilling. Try to refuel on the lower side of specified level. If spilled, be sure to wipe it off completely.
- After refueling, be sure to close tank cap firmly.



A0055020



A0055040

**Do not allow any fire to approach oil**

Inflammation may result if any fire should approach fuel, hydraulic oil or engine oil. Observe following rules strictly:

- Do not allow lighted cigarette or match to approach any inflammable matter.
- Cap of fuel or oil can should be closed tightly.
- Fuel or oil should be stored in well ventilated area.
- Fuel or oil should be stored at a specified location and do not allow any unauthorized person to approach.
- Do not leave the spot during replenishment.  
During refueling in particular, be sure to observe rules provided in preceding subparagraph "Safety during refueling".
- Any fuel or oil spilled during replenishment should be wiped off immediately.



A0055020



A0055040

**High temperature**

Immediately after operation, engine oil or hydraulic oil is hot and pressure has been built up inside the hydraulic tank. Under such condition, you may incur scalding by removing cap or replacing oil, coolant or filter. Wait for the temperature to drop before proceeding with following procedure:

- To avoid blowing of hot oil, shutdown engine and wait for the temperature to drop. Loosen cap slowly to release pressure before removing it. (Feel the oil temperature by holding your hand close to the tank surface but not by touching it directly.)

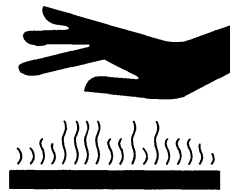

A0055050

**Cautions as to asbestos dusts**

Inhaling air including asbestos dusts may cause lung cancer. Though the machine does not use asbestos, wall surfaces and ceilings of buildings in working ranges of the machine may contain asbestos. Be sure to observe following when you work using materials which may contain asbestos.

- Wear designated dust mask, if necessary.
- Do not use compressed air for cleaning.
- To prevent asbestos dusts from flying, sprinkle water during cleaning.
- Be sure to work in the wind when you operate the machine on site possibly subject to asbestos dusts.
- Strictly observe specified regulations concerning jobsite and environmental standard.



A0055060

**To avoid injury due to crane**

To avoid accident resulting in serious injury or death, do not place any part or whole of your body in clearances such as follows:

For example

- Between boom and undercarriage
- Between outrigger float and ground
- Between boom or post and hoist cylinder
- Between winch drum and wire rope
- Between sheave and wire rope
- Between track and ground



A0055130

**Exhaust gas**

For starting up engine or handling fuel, cleansing oil or paint indoors or in poorly ventilated area, be sure to open window or door for prevention of poisoning by gas. However, do not use this machine, which is not conforming to the explosion proof order, in the area where only the machines conforming to the explosion proof order can work. If ventilation is still insufficient even with window or door opened, install ventilation fan.

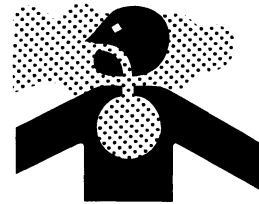

A0055060

## 2. Rules for Operation

### 2.1 Before starting up engine

#### Securing safety in job site

- Make sure that there is no danger in job site before starting your work.
  - Check ground and surface conditions of job site to select the most suitable work method.
  - Eliminate inclination in job site where possible, before proceeding with your job. In case of heavy cloud of dust, water the job site.
  - For work on road, place guide or fence to prohibit entry and secure safety of pedestrian or machine.
  - Take necessary measures to prohibit entry of unauthorized person to job site.
- Approaching moving machine may lead to serious accident of injury or death by contacting or being caught.
- When traveling in a site covered with water (such as liver, pond or bog), examine the ground condition, water depth and water flow rate not to enter water deeper than the allowable level.
- ★ See “OPERATION, 2.11 [2] Allowable depth of water” for detail.

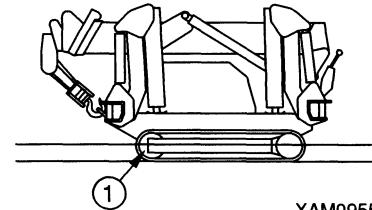

XAM09550

#### Checking the engine before starting up

- Prior to the first start up of the day, conduct following inspection:  
Its negligence may result in serious accident involving injury or death.
- Check for leakage of fuel or oil, deposit of inflammable matter around engine or battery.
    - ★ See “OPERATION, 2.1.1 Work-around check” for detail.
  - Check fuel and hydraulic oil tanks for proper level, air cleaner for clogging, wiring for any damage and function of safety systems and instrument.
    - ★ See “OPERATION, 2.1.2 Checks before starting” for detail.
  - Make sure that control levers are in Neutral. Check that control linkages function satisfactorily.
- Based on the result of above checking, be sure to correct any abnormality.



A0055020

#### Rules for starting up the engine

- Before starting the engine, check if no one or no obstacle is in the crane working range.
- Be sure to sound horn for warning when starting up your engine.
- Do not use short circuiting of starter circuit to start the engine. It may cause fire.

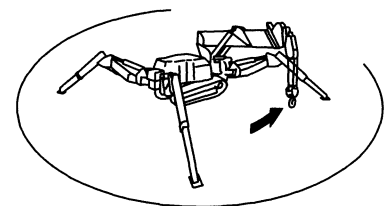

XAM09530

## 2.2 After the engine has started

### Inspection after starting the engine

Negligence of inspection after starting engine will delay detection of trouble in machine resulting in personal injury or damage of machine.

Inspection should be carried out in a wide area without obstacles. Do not allow anyone to approach the machine.

- Check actuation and travel of the machine, function of outrigger, and function of crane including winching and hoisting, telescoping, and swinging of boom.
- Check for abnormal sound, vibration, heat or smell of the machine or leakage of air, oil or fuel. Pay particular attention to the leakage of fuel.
- Any abnormality should be corrected whenever it is detected. Using the machine without correction may cause unexpected personal injury or machine trouble.

### Rules for starting the machine

In order to avoid serious injury or death, be sure to observe following rules whenever you move the machine.

- Let the machine assume "Travel Position" as shown in sketch to the right: Do not travel the machine without locking the hook block.
- Lower and retract the boom all the way.
- Engage the hook block to its hanger.
- Retract the outrigger.
  - ★ See "OPERATION, 2.5 Travel position of the machine" for detail.
- Make sure again that there is no person or other obstacle around, before starting to travel.
- When starting, sound the horn for warning.
- When travelling, be sure to stand in front of the travel lever located on the travel control panel side. When the machine starts moving, walk and keep your pace with the machine speed.
- This machine is not designed to carry any personnel or load on its carrier or boom, when travelling.

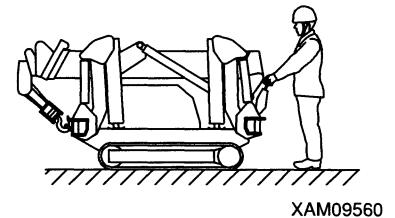

### Rules for reversing travel or changing travel direction

In order to avoid serious injury or death, be sure to observe following rules whenever you move the machine.

- Before switching from forward to reverse travel or vice versa, decrease speed on the earlier side and bring the machine to a complete stop.
- For switching forward/reverse or changing direction, sound the horn to give warning.
- Make sure that there is no person around the machine. Particularly, because there is a blind spot in front of the machine, stop the machine as necessary to make certain that there is no person in front or around the machine.
- When traveling in reverse, the operator must check the safety of the rear area.
- Use a guide wherever hazardous or view is poor.
- Do not allow any person to enter any area where you are travelling or changing direction in.

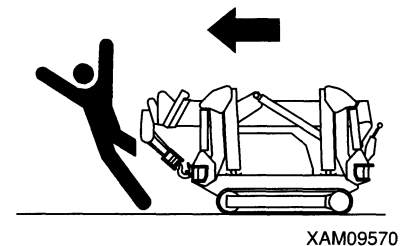

**Rules for traveling**

In order to avoid serious injury or death, be sure to observe following rules whenever you travel the machine.

- While travelling, pay attention.
- Avoid speeding and making jerky start or stop motions of sudden turns. Avoid zig zag travel.
- When reversing the machine, you should be specially careful about your footing. Decrease machine speed to a slow level and operate the machine carefully so that you will not loose your footing due to obstacles or irregularity.
- When any abnormality is detected during operation such as abnormal noise, vibration, smell or leak of fuel or oil, stop the machine immediately at appropriate location to check for the cause.
- Avoid making sudden change of direction. It may cause the loss of balance or damage the machine or nearby structure.
- For travelling over uneven ground, use low speed to avoid tipping over and do not make jerky operation for changing direction.
- Try not to go over obstacle where possible. If inevitable, use as low speed as possible. Further, do not go over any obstacle which may cause the machine to incline extremely (more than 10 degrees).
- While travelling, for prevention of contacting with other machine or structure, keep a roomy distance from them.
- When traveling in a site covered with water (such as liver, pond or bog), examine the ground condition, water depth and water flow rate not to enter water deeper than the allowable level.  
See "OPERATION, 2.11 [2] Permissible water depth" for detail.
- Before travelling over any bridge or other structure in privately owned land, make sure that they withstand the weight of this machine. As for public road, check with competent authority and follow its instruction.

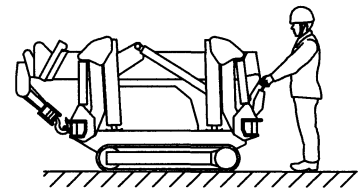

XAM09560

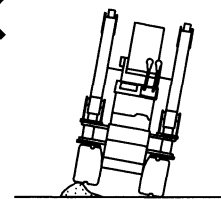

XAM09580

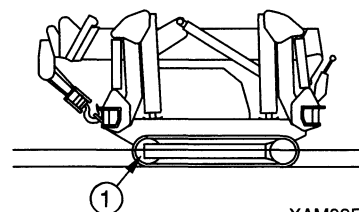

XAM09550

**Rules for traveling on slope**

When traveling on the sloping ground, be sure to keep the following items.

- When travelling on a slope, operator should always stand on upper side of the machine.
- When travelling on slope, use care for tipping over or skidding sideways.
- Do not attempt to change travel direction on or to cross a slope. Go down to flat area and detour for safety.  
★ See "OPERATION 2.11 [3] Rules for travelling up- or downhill" for detail.
- On grass, fallen leaves or wet steel plate, even with small inclination, machine is more likely to skid sideways than imagined.
- Avoid to position your machine laterally to slope where possible and try to slow down. When going downhill, travel slowly. Apply brake (travel lever in Neutral position) as necessary.

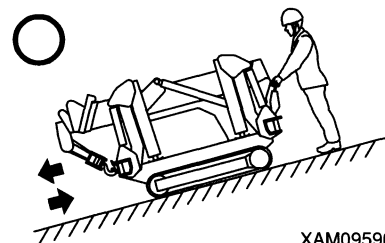

XAM09590

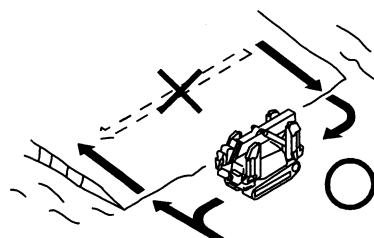

XAM09600

### Be careful about tipping over on unsteady ground

In order to avoid serious injury or death, be sure to observe following rules whenever you have to travel over unsteady ground:

When travelling on a slope, operator should always stand on upper side of the machine.

- Do not enter soft ground. It may be difficult to escape.
- Do not approach precipice, shoulder, deep ditch because ground is unsteady around there. Landslide due to mass or vibration of the machine will cause the machine to tip over or fall down. Ground immediately after heavy rain fall, blasting or earthquake will be prone to landslide.
- Over a banking or near an excavated ditch, ground is unsteady. Do not approach where possible. Machine may incline due to its mass or vibration.

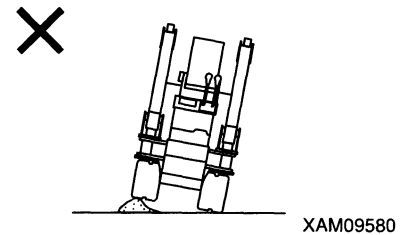

XAM09580

### Rules for accumulated snow or frozen ground surface

In order to avoid serious injury or death, be sure to observe following rules whenever you have to travel over accumulated snow or frozen ground surface:

- Snow accumulated or frozen surface is slippery even with a small inclination. Slow down and avoid making jerky start, stop or turn. Particularly going up or down a slope is slippery and hazardous.
- Frozen surface becomes unsteady to travel the machine on. The ground will become soft as the temperature rises.
- In a cold climate, before attempting to lift, check to see that the load is not stuck to ground or anything else because of freezing. Attempting to lift a load frozen to the ground or anything else without knowing, is dangerous.
- In cold climate, do not touch metal surface or the like with your bare hand or finger. Touching metal surface of a machine in extremely cold climate may cause your skin to freeze to metal surface.
- Remove any snow or ice deposited on your machine as it makes difficult to read caution plates. Particularly, if deposited on boom it should be removed without fail, as it may fall down.

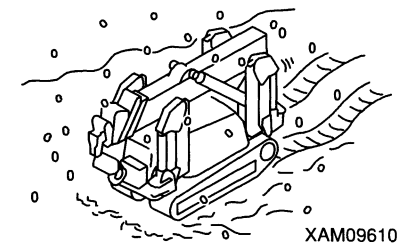

XAM09610

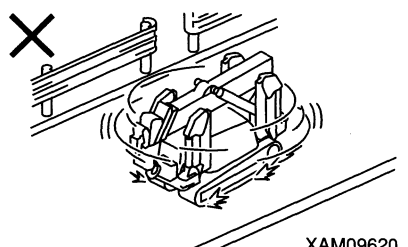

XAM09620

### Rules for parking

- For parking the machine, select flat surface without danger of falling rock, land sliding or being flooded.
- When parking on slope, apply a chock to prevent the machine from rolling.
- For parking on road, place caution sign including flag, protection fence, flood light or the like within the limit not to disturb traffic.
- Before leaving the machine, shutdown the engine. Be sure to keep the engine key at designated location.

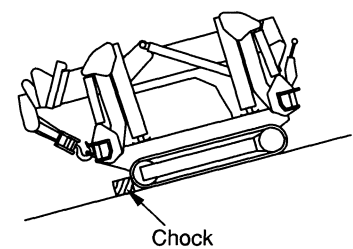

Chock

XAM09630E

**Rules for cold climate**

- After finishing work, wipe any water, snow or mud off the wire harness, connector ①, switches and sensors before covering them. Freezing of ingressed water may cause the machine to malfunction, resulting in unexpected accident.
- Remove or defrost snow or ice around swing gear, boom or winch and make sure that they function properly.
- Conduct sufficient warm-up run. Without sufficient warm-up run, reaction of the machine to control levers and switches will be slow, leading to unexpected trouble.
- Rapid acceleration of the engine immediately after its start-up should be avoided.
- Operate the control lever to relieve hydraulic pressure (raise the pressure to exceed its set level so that hydraulic oil is released to its tank) to increase temperature of oil in the circuit. This will improve reaction of machine and prevents malfunctioning.
- When electrolyte is frozen, do not charge the battery or try to start up engine with other battery. It may cause inflammation of the battery. Before charging battery or starting up the engine using other battery, first defrost the electrolyte and make sure that there is no leakage.

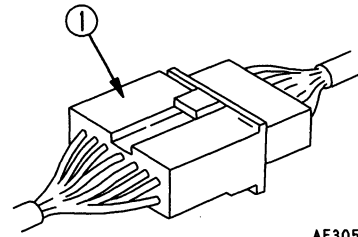

AE305820

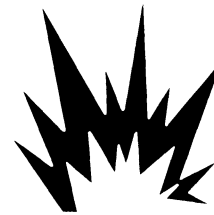

A0055110



## 2.3 During crane operation

### Inspection before starting your work

Make sure that function of safety system and crane is normal.

- Operate control levers and switches at no-load and make sure that they function normally. If any abnormality is detected, correct it immediately.
- Make sure that safety systems including over-hoist warning system function normally.

### Rules for selecting location for placing outrigger float

For crane work, be sure to use the outrigger. Performing crane work without outriggers set, may result in tipping over of the crane.

Be sure to place outriggers on level, hard and steady ground. Placing them on following type of ground is hazardous:

- Random paved asphalt surface
- Thin concrete paved surface
- Stone paved surface
- Where underneath of pavement having been eroded by water to become hollow, surface appears to be solid but inside is soft.
- Near any shoulder or hole for work.
- Inclined ground.

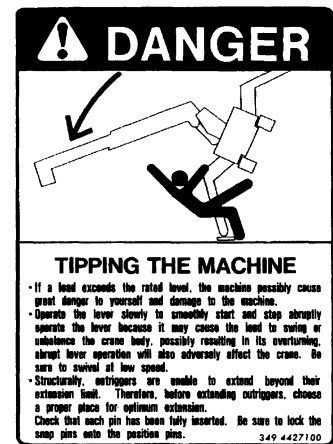

### Rules for setting up outrigger

In order to prevent accident of serious injury or death, for setting up outrigger, observe following rules:

- When setting up outrigger, do not allow any person to approach. Serious accident may result, such as your foot being caught by outrigger float.
- Except for extending or retracting outrigger cylinders, have the engine shutdown, because if anyone inadvertently touches the outrigger switch, the cylinder may be actuated unexpectedly and cause an accident.
- All the outriggers should be extended firmly. After having extended outriggers, make sure that they are all well grounded.
- Over soft ground, use a plate under the outrigger floats.
- When you must set up outrigger near a shoulder, take every possible measures to prevent collapsing of the shoulder.
- Outrigger should be set up while checking with leveling instrument so that the levelness of machine is secured. During crane work as well, the leveling instrument should be referred to once in a while in order to maintain the levelness of machine.
- For working on slope, be sure to have the ground under outrigger float and track leveled before setting up the outrigger. Setting up outrigger on inclined ground without having it leveled, may cause the machine to become unstable.

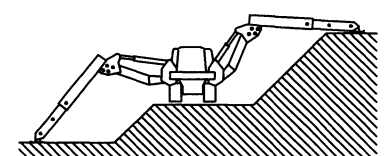
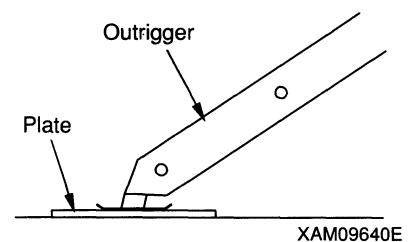

**Watch out for overhead power line**

- Do not allow the machine to touch overhead power line. If it is high tension line, electrification may result by just approaching.
- Observe following rules in order to avoid accident:
- At any job site where there is a possibility of boom or wire rope contacting power line, discuss with the power company or make sure that measures set forth in related regulations (such as placing a guard, sheathing the line or posting caution board) have been taken, before starting the work.
- Wear rubber soled shoes and rubber gloves and be careful not to allow any portion of your body which is not protected by rubber or the like to come in contact with boom, wire rope or machine.
- Place a guide to watch for the boom, wire rope or machine not to approach too closely to the power line. Sign for emergency should be established beforehand.
- Inquire about voltage of power line at job site.
- Be sure to keep following distance between the boom, machine and power line:

	Power line voltage	Minimum safety distance
Low voltage (Distribution line)	100 · E200V	2m
	6,600V	2m
Special voltage (Transmission line)	22,000V	3m
	66,000V	4m
	154,000V	5m
	187,000V	6m
	275,000V	7m
	500,000V	11m

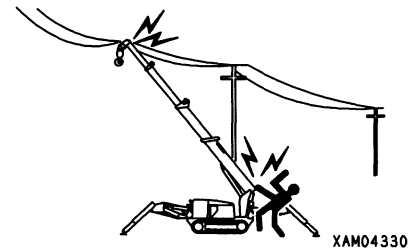

**Corrective action against electro static charge accident**

When electro static charge accident occurs, keep calm and follow the steps below without being confused.

**1. Emergency communication**

Contact the electric power company or related controlled company to receive instructions such as stopping power transmission and emergency measure.

**2. Evacuation of the construction interest from the periphery of the machine**

To prevent secondary disaster, evacuate the construction interest such as workers from the periphery of the machine.

If the machine bears electro static charges and worker receives electric shock when he is holding slinging rope or guide rope, the worker should get out of the situation by himself/herself.

NEVER try helping him/her out. It will cause secondary disaster.

**3. Emergency measure**

If the machine bears electro static charges to cause worker to receive electric shock, take following emergency measures.

- (1) When the machine is operational, immediately operate the machine to move away structural part of the machine from contact part or range with the cause of electro static charges. Be careful not to break power line.
- (2) Completely move away the cause of electro static charges from the machine, check that the machine does not bear them, rescue worker who received electric shock, and carry him/her to hospital at once.

**4. Corrective actions after accident**

Do not use the machine without taking corrective actions after accident; this may cause unexpected accident or failure.

Contact your dealer to receive service.

**Rules for crane work at place where high-output radio waves are issued**

If you operate crane near device which issues high-output radio waves such as radar, TV set, radio broadcasting antenna, etc., structural part of crane is subjected to radio waves, putting you in very hazardous situation by generating induced current. It may put mechatronics out of order.

When operating crane in a place above, install grounding between crane body and ground. Slinging workers should wear rubber boots to prevent electric shock from receiving by contacting hook or wire.

**Pay attention to weather information**

- When there is any possibility of lightning, discontinue crane work, ground the load immediately and retract the boom. However, do otherwise in case involving possible danger risking lives.
- When load sways due to wind, the machine becomes unstable. If such is the case, ground the load immediately and retract the boom.
- When the maximum instantaneous wind velocity reaches 10m/s, discontinue the crane work, ground the load and retract the boom.
- Even when the maximum instantaneous wind velocity is less than 10m/s, the greater the lifted load, the higher the load is lifted or the longer the boom, the greater the influence of wind. Work should be carried out with sufficient caution.
- When lifting any load having wide area being exposed to wind such as steel plate, wind from front, rear or side of boom can cause tipping of the machine or damage to the boom. Sufficient attention should be paid.
- In case of earthquake, suspend your work and wait until it settles down. Chart below is the guide of wind velocity and its effect. Wind velocity in weather information represents a mean velocity (m/s) for 10 minutes at 10 meters above ground.

Wind velocity (m / s)	Effect of wind
Up to 0.3	Quiet breeze. Smoke rises straight up.
0.3 – 1.6	Direction of wind can be known as it streams but anemoscope does not detect it.
1.6 – 3.4	Wind felt by face. Leaves move constantly and anemoscope starts actuating.
3.4 – 5.5	Leaves and twigs moves constantly. Light weight flag opens.
5.5 – 8.0	Dust rises, small piece of paper flies and twigs move.
8.0 – 10.8	Shrub with leaves starts to rustle. Wave crest develops in lakes and marshes.
10.8 – 13.9	Big branches move. Power line howls. Hard to use umbrella.
13.9 – 17.2	Entire tree sways. Hard to walk against headwind.
17.2 – 20.8	Branches break. Impossible to walk against headwind.
20.8 – 24.5	Slight damage incurred by residential house. (Chimney falls and roof tiles come off)
24.5 – 28.5	Not frequently experienced inland. Trees uprooted. Major damage to houses.
28.5 – 32.7	Scarcely experienced. Destruction in broad region incurred.

### Rules for wire engaging

- Before lifting load, make sure of the following: Lifting load without checking, may result in serious accident of injury or death by falling of the load or tipping over.
  - Observe values in rated total load chart.
  - Lift at the center of gravity of load.
  - Make sure that wire rope for hook block is in perpendicular.
  - After lifting off the ground, stop hoisting the load once to make sure that the load is stable.
- Before lifting wired load, be sure to check that wire rope holding device at hook block is securely in place. If not, wire rope may come off the hook block, causing serious accident with the load falling.
- When the angle of wire rope while lifting a load is great, even with the load of same weight, the load applied to the rope will be greater and can break the rope. Wiring work should be performed with careful attention paid so that wire rope is not exposed to unreasonable force.
- Lifting a long shaped load is dangerous as the load is unstable. In such case, lift it vertically with connect ropes to each end of the load for improvement of stability.

### Rules for handling wire rope

Multiple lifting may cause the center of gravity to shift and result in serious accident such as tipping over of crane , falling down of load , and breakdown of crane. Be sure not to implement multiple lifting using two cranes or more.

In the event that multiple lifting is not prohibited by regulations in the area where operations are conducted and operators are obliged to use two cranes or more because of either environments or requirements , observe the following rules on their own responsibility.

### Rules for crane operation

- Any work beyond the capability of machine will be a cause for serious accident including tipping over or breakage or any other trouble. Perform crane work in accordance with the rated total load chart.
- Never travel with any load lifted. Crane may tip over resulting in serious accident of injury or death.
- Be sure to operate slowly. Sudden operation of lever or accelerator may cause a load to sway, fall or collide into surroundings. Swing motion in particular should be performed at low speed.
- There is a danger of load falling or contacting which may lead to serious accident of injury or death. Do not allow any person to enter inside the working radius or underneath the load. Working radius increases due to bend of boom as a load is lifted, which should be taken into account.
- Crane work in poor visibility or bad weather is dangerous. In dark area, use flood light or other lighting system to secure brightness. If view is poor due to bad weather (rain, fog, snow, etc.), discontinue your work and wait for weather to improve.
- Do not use the crane for any duty other than its primary usage, such as lifting worker with it.
- Crane work should only be started after turning ON the over-hoist alarm switch. Whenever the hook block is over-hoisted the warning buzzer will sound to notify you.
- Crane work should be started only after over-hoist preventive device switch is turned ON. When hook block is excessively hoisted, buzzer will sound for warning.
- When the buzzer of over-hoist preventive device sounds, take your hand off the winch lever immediately. Hoisting of the hook block will stop. Then, operate winch lever to Lower position (push forward) of the hook block.
- As you extend the boom, the hook block will be hoisted. Therefore, when you extend the boom, keep lowering the hook block by pushing the lever forward.
- If, during work, overloading should take place, lower the load by pushing winch lever forward. Rapid hoisting or lowering of the boom should be avoided because it may cause an accident by tipping over.
- Volume of hydraulic oil in each cylinder will vary as its temperature changes. If you leave the machine stopped with a load suspended, the oil temperature will drop as the time elapses and as the volume reduces, hoist angle or length of the boom will also be reduced. If such is the case, correct it by performing action for boom hoist or extension appropriately.
- Do not leave the machine leaving a load suspended. If you have to, be sure to lower the load.
- When not in use, have the hook block wound up to prevent any person from colliding with empty hook block.

### Rules for operating the winch

- Do not allow any person to enter under a lifted load.
- When lifting a load, be sure to stop it at a point where the load is off the ground to check for stability of the load and safety of weight before continuing to lift.
- Dragging laterally, pulling in or lifting at an angle to the load is prohibited. Crane may tip over or be damaged.
- Hoisting the hook block excessively may cause the block to collide into boom, break the wire rope and cause the hook block and load to fall down, leading to a serious accident. Use sufficient care not to over-hoist the hook block.
- Lift a load while using care not to allow wire rope or lifted load to contact with obstacle such as tree or structure. If entangled with obstacle, do not attempt to hoist forcibly but disentangle it first before continuing to lift.
- Do not use disorderly wound wire rope off the winch drum. Leaving this rope wound disorderly on drum not merely shortens the useful life but can break the rope causing serious accident. Observe following rules to prevent wire rope from being wound disorderly:
  - Do not ground the hook block.
  - When lowering the hook block below ground level for underground work or the like, be sure to leave minimum of 3 windings of the rope on winch drum.
- When hook block rotates with the rope twisted, remove such twist completely before resuming your work.
  - ★ See "OPERATION, 4.2 Measures to take when wire rope is twisted" for detail.

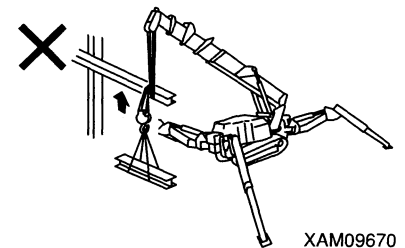
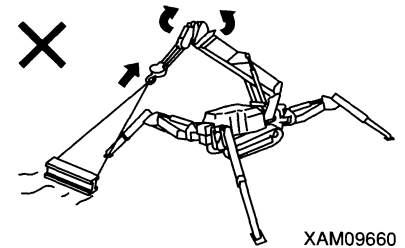

### Rules for operating the boom

- Operate the boom control lever as slowly as possible. In Particular, rapid lever operation with a load lifted will cause the load to sway and give machine a big shock, resulting in damage to the crane or tipping over of the machine.
- Lowering the boom causes working radius to increase but the corresponding rated total load to reduce. To perform your work while hoisting or lowering the boom, use sufficient care so that the mass (weight) of the load with the boom lowered to the lowest angle does not result in overloading.
- Dragging laterally or pulling-in a load with boom hoisting/lowering or telescoping is strictly prohibited.
- When you telescope the boom, pay attention to the hoisting move of hook block.
- Telescoping of the boom should be done carefully while making sure that the hook block is being hoisted or lowered. Extending the boom causes working radius to increase but the corresponding rated total load to reduce. To perform your work while telescoping the boom, use sufficient care so that the mass (weight) of the load with the boom extended to the maximum does not result in overloading.

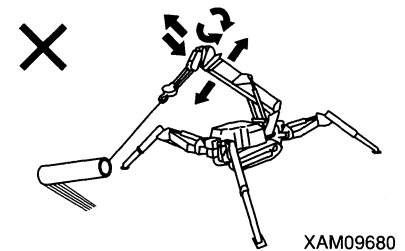

### Rules for making swing motion

- Before swinging, check for safety of surrounding and sound horn.
- When crane hoisting angle is small, be careful not to allow boom to hit operator or machine.
- Swing lever should be operated as slowly as possible. Start smoothly and swing at low speed before stopping softly. Rapid lever operation with a load lifted will cause the load to sway and the balance of machine to be lost, which may result in damage to or tipping over of the crane.
- Dragging in or erecting a load by means of swing motion is strictly prohibited.
- For swinging 360 degrees with a load lifted, be sure to place outriggers in the standard pattern as shown in the sketch to the right. In any configuration other than this, you are not supposed to make 360-degree swing. Further, you should remember that, even with the outriggers placed to the maximum extension, lateral stability is not necessarily perfect.
- For lifting a load or making a swing, be careful so that wire rope or lifted load does not contact with obstacle such as tree, steel structure or the like. If entangled with obstacle, do not force to hoist the load but disentangle it first.
- Depending on the extended length of outriggers, boom hits outriggers at the time of swing operation, possibly damaging crane or tipping over the machine. Be careful not to allow boom to hit outriggers at swing operation.

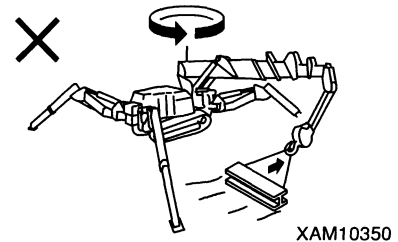

XAM10350

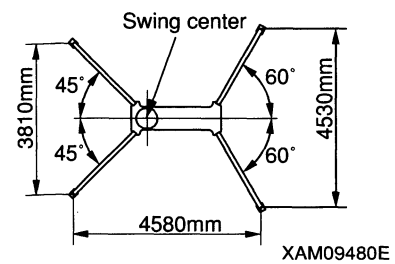

XAM09480E

### Rules for joint lifting work

Multiple lifting may cause the center of gravity to shift and result in serious accident such as tipping over of crane, falling down of load, and breakdown of crane. Be sure not to implement multiple lifting using two cranes or more.

In the event that multiple lifting is not prohibited by regulations in the area where operations are conducted and operators are obliged to use two cranes or more because of either environments or requirements, observe the following rules on their own responsibility.

### Working for a lifting height which involves below ground level

Do not use this machine, which is not conforming to the explosion proof order, in the area where only the machines conforming to the explosion proof order can work.

- For winching wire in below-ground-level work, be sure to leave at least 3 windings of rope on the winch drum.
- Let every one understand signs in use.
- Operate crane with particular carefulness.



### 3. Rules for Transporting a Crane

#### Rules for loading to and unloading from truck or trailer

- Loading and unloading involves a lot of danger. Particular care should be used.
- Select level and hard ground for loading and unloading. Secure plenty of distance from shoulder.
- Angle of ramp board should be less than 15 degrees. Set the distance between the boards to match the track centers.
- For loading or unloading of the crane, be sure to let the crane assume "Travel position" with position pins (4) securely inserted at the rotary.
  - ★ See "OPERATION, 2.5 Travel Position of the Machine" for detail.
- Be sure to load the machine by travelling backward. Loading by travelling forward may cause tipping over.
- Be sure to unload the machine by travelling forward. Unloading by travelling backward may cause tipping over.
- For loading or unloading, run the engine at idling speed and drive the machine at low speed.
- Use ramp board having sufficient strength in terms of its width, length and thickness for safe loading and unloading operation.
- To avoid side skidding of the machine on ramp board, remove dirt off the undercarriage. Also keep the board clean with any deposit of grease or oil removed. Be extra careful on rainy days as it gets slippery.
- Never correct travelling course on the board. If you want to, let the machine get off the board to change the direction.
- For changing direction on truck bed, operate slowly because foothold is unsteady.
- After loading, engage chock and lock the machine securely with wire rope or the like.
  - ★ See "OPERATION, 5.1 Loading and Unloading Procedure" for detail.
  - ★ See "OPERATION, 5.3 Rules for loading the machine" for detail.

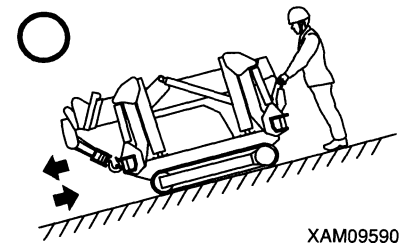
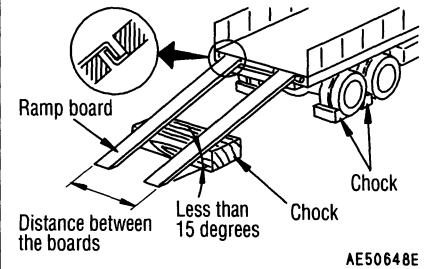

#### Rules for transport

When transporting the machine, follow local rules and regulations.

**Rules for loading and unloading by means of a crane**

Observe following rules for loading and unloading the machine with a crane in use:

- For lifting up the machine, either engage the hook ② of the lifting crane to the hanger bracket provided on top surface of the boom or use a hanging device ① for engaging such hook ②.
- The crane and hangers ① (wire ropes, shackles, etc.) for lifting duty should be sufficiently strong for the mass (weight) of the machine.
- For lifting up the machine, be sure to put it in Travel position and securely insert four positioning pins to rotary part of outrigger.

Location of center of gravity of the machine is established with the machine in travel position. Also, for letting the machine assume travel position, make sure that hook block is engaged to prescribed position and rope is tightened sufficiently to prevent boom derrick cylinder from extending.

★ See “OPERATION, 2.5 Travel Position of the Machine” of detail.

- Holding the machine suspended for long time, may cause the boom derrick cylinder ③ to extend, putting the machine out of balance with the center of gravity shifted. Duration of suspension should be limited to about 10 minutes.
- For suspending the machine for long time (over 10 minutes) or moving it with helicopter, use such hanger as shown to the right for the safety.

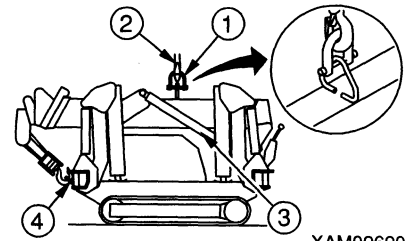

XAM09690



XAM03900

## 4. Rules for Handling the Battery

### Rules for Handling the Battery

Electrolyte contains dilute sulfuric acid and it generates hydrogen gas as well. Its improper handling may result in injury or fire.

Observe following rules:

- Do not allow any fire including lighted cigarette to approach battery.
- For handling battery, be sure to wear goggles and rubber gloves.
- If electrolyte gets on your clothing or skin, wash it away with plenty of water immediately.
- If electrolyte gets in your eyes, wash it away and see doctor promptly for treatment.
- If you swallow electrolyte inadvertently, drink plenty of water, milk, raw eggs or vegetable oil and see doctor immediately.
- Clean the top of battery with wet and clean cloth. Use of organic cleanser such as gasoline or thinner is prohibited.
- Tighten battery caps securely.
- When electrolyte is frozen, do not charge or try to start engine with other power supply. It may cause the battery to catch fire.
- For charging or starting engine with other battery in use, first defrost the electrolyte and make sure it is not leaking.
- Before charging the battery, be sure to remove it from the machine.



A0055040

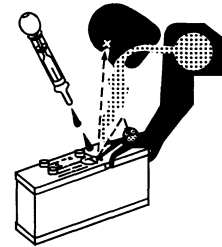

A0055090

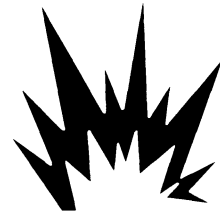

A0055110

### Rules for starting the engine with booster cable in use

Improper connection of booster cables may cause fire. Observe following rules.

- Engine should be started with 2 persons involved. One should be standing on the operating position on the travel control panel side.
- For starting up the engine with other machine involved, make sure that two machines do not come in contact with each other.
- Before connecting booster cables, starter switch keys should be turned off on both of the normal and troubled machines.
- Booster cables should not be connected in opposite {(+) with (-) and (-) with (+)}.
- Connection should be made with (+) terminal first and disconnected with (-) terminal (earthing end) first.
- Last grounding connection should be made with (-) terminal of battery of the machine with failure.
  - ★ See "OPERATION, 8.4 Starting up with booster cable in use" for detail.
- When disconnecting booster cables, avoid any contact between the cable clips or between the clip and machine.

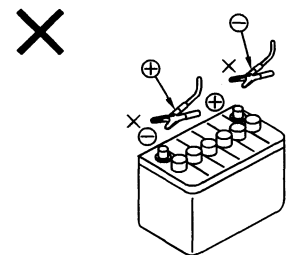

A0067320

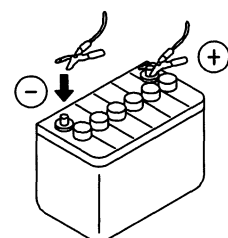
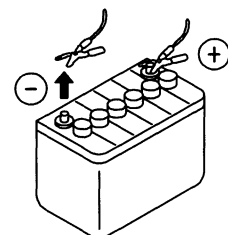

XAM04590

**Rules for charging the battery**

Battery can explode with its improper handling for charging. Follow the direction provided in this manual as well as battery manual and observe the rules shown below:

- ★ See “OPERATION, 8.3 Rules for charging the battery” for detail.
- Move the battery to well ventilated area and remove caps to allow diffusion of hydrogen gas and prevent explosion.
- Adjust the voltage of charger to that of battery to be charged. Incorrect voltage adjustment can result in overheating and explosion of the battery.
- Securely connect the (+) charging clip of the charger to (+) terminal of the battery, before connecting (-) charging clip to (-) terminal of the battery.
- Charging current should be set to the value less than 1/10 of rated capacity of the battery. In case of boosting charging, set it below the value of rated capacity of the battery.
- Charging battery excessively may lead to inflammation and explosion with electrolyte leaking or drying up.

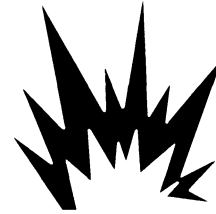

A0055110

## 5. Rules to Observe in Connection with Services

### 5.1 Prior to conducting services

#### Notification on trouble

Conducting any service that is not described in this manual may result in unexpected trouble. Notify your dealer about it.

#### Proceed with inspection and service only after cleaning the machine.

- Before conducting inspection and service, clean the machine to prevent dust from entering and so that you can service safely.
- Inspection and service conducted with the machine remaining smeared will not merely makes it difficult to detect deficiency, it will cause dust or dirt to enter your eyes or you incur injury by slipping to fall.
- For washing the machine, observe following:
- Wear slip proof shoes to prevent from slipping due to wet foothold.
- When using high pressure steam for cleaning, wear protectors. Avoid accident of getting a cut or dirt entering your eyes by touching the high pressure.
- Do not water electric systems (sensors, connectors, receiver boxes) ①. Water entering electric system is hazardous as it causes actuation deficiency, leading to malfunctioning.

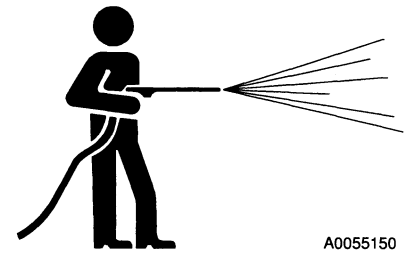

A0055150

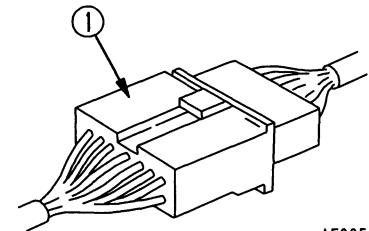

AE305820

#### Keeping job site neat and clean.

Keeping job site neat and clean. For your working safety, keep your job site clean by moving tools and hammers out of your way and wiping off slippery grease or oil. Leaving job site disorderly will expose you to risk of stumbling and slipping to incur injury.

#### Joint work should be performed under direction of leader.

For performing machine repair or installation or removal of attachment, designate a leader and follow his or her direction. Failure to understand command among joint workers can lead to unexpected accident.

#### Use proper tool.

Do not use broken, deteriorated or wrong tool for your purpose. Chip of rounded chisel or hammer can even blind you if it gets in your eyes.



A0055120

**Lighting system**

- For checking fuel, oil or electrolyte, use lighting system of explosion proof type. If not, an explosion may result.
- Working in dark area without flood light may lead to accident. Be sure to use lighting properly. Just because it is dark, do not use fire of cigarette lighter or the like in place of lighting. Fire or explosion due to inflammation of electrolyte gas could result.



A0055160

**Shutdown engine for inspection or service**

- For inspection or service, be sure to park the machine on level and hard ground without possibility of falling rocks or land slide or being flooded, with boom totally retracted and lowered and engine shutdown.
- Operate all the crane control levers back and forth for a few repetitions to release residual pressure in hydraulic system.
- Apply chocks to rubber tracks to prevent the machine from rolling.
- Any service personnel should be careful so that his or her body or clothing does not contact any moving part.

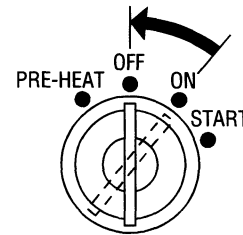

XAM11190E

**Prevention of fire breaking out.**

During service work, dangerous object having risk of inflammation including fuel or battery will be handled. Following should be strictly observed:

- Store oil and grease according to law.
- Do not leave place of your duty during replenishment of fuel and oil.
- For parts cleaning, use incombustible type of cleanser and avoid inflammable light oil, gasoline or the like.
- Do not smoke while conducting inspection or service. Smoke at designated area only.
- When inspecting fuel, oil or electrolyte, use explosion proof lighting and do not use cigarette lighter or matches in place of lighting.
- Loosened or damaged electric connection can cause fire by short circuiting. Check it during pre-operation check.

Make sure that fire extinguisher is available in the vicinity of your place of inspection and maintenance.



A0055020



A0055040

## 5.2 During service work

### Unauthorized entry prohibited

During service work, do not allow any unauthorized person to enter.  
Place a guard as required. Use particular care during grinding, welding or driving work.

### Action to take when abnormality is found during inspection

- During inspection, if abnormality is found, be sure to correct it.  
Using the machine without correcting defect may result in accident involving injury or death.
- Depending on the trouble involved, contact your dealer.

### Do not drop tool or parts into the machine

- When carrying out inspection with access panel or filler port of tank opened, try not to drop bolt, nut or tool into the machine. Dropping them may cause damage or malfunction of the machine, leading to accident. If you should drop anything, be sure to pick it up.
- Do not leave anything in your pocket other than those required for the inspection.

### Be careful about noise

High level of noise around you can cause you to incur difficulty in hearing or to be deafened. Be sure to use ear covers or plugs during engine service or the like which exposes you to noise for long period of time.

### Service work with engine running should be performed with 2 or more persons

For avoiding accident, do not perform service work with engine running.  
If inevitable, observe following:

- One person should stand at engine operating position on travel control panel side so that at anytime he can stop the engine, and always keep contacting each other.
- For working near any rotating part, use care because there is a risk of being caught.
- Do not touch control levers. If inevitable, be sure to give the partner a signal to let him or her evacuate from danger zone.
- Never touch alternator drive belt or the like with your body or tool because it can result in amputation.

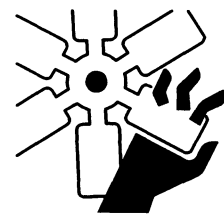

A0055210

**Care to be used when working**

- Park the machine on level, hard ground with boom totally retracted and lowered.
- For performing service from underneath the machine, let the machine float with outrigger extended to maximum. If the machine is unstable and sways then, engage support under its front and rear for stabilization.
- Do not mount yourself on the machine.



A0055140



AD305870

**Care to be taken while replenishing with fuel or oil**

Fuel or oil may ignite when fire approaches to it.  
Particularly diesel fuel being in use, observe following:

- Stop engine while replenishing.
- Do not smoke during replenishment.
- Wipe off any spilled fuel or oil immediately.
- Tighten fuel or oil cap securely.
- Carry out fuel or oil replenishing work at well ventilated area.
- Do not leave the spot during replenishment.



A0055020



A0055040



**Care to be taken during hammer work**

For hammer work, wear protector such as goggles or helmet and place brass rod or the like between object and the hammer to blow.

Giving impact to hard metal parts such as pin or bearing, may cause its chip to get in your eyes.

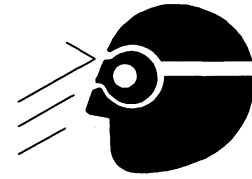

AE305880

**Care to be taken during welding repair work**

Welding work should be performed at well equipped place by qualified person.

Welding work may cause generation of gas, fire or electrification. Non-qualified person should absolutely refrain from doing it.

Qualified welding personnel should observe following:

- For prevention of battery explosion, disconnect battery terminal.
- Any paint on welding area should be removed for prevention of gas generation.
- Heating hydraulic equipment, piping or rubber hose or its vicinity may cause inflammable gas or steam to ignite. Avoid heating such area.
- Heating pressurized piping or hose directly may cause them to suddenly break. Use fireproofing sheath.
- Wear protector.
- Make sure to have good ventilation.
- Stow away any inflammable object and have fire extinguisher ready.
- Do not ground any part near electrical equipment. This may cause electrical equipment to malfunction.

**Removing battery terminal**

For performing repair of electric system or welding work, disconnect negative terminal of the battery to stop electric current.

★ See "OPERATION, 8. Handling of battery" for detail.



A0055170

**Care to be taken during rubber track tension adjustment**

- Internals of rubber track tension adjust system is packed with grease, which is highly pressurized with track tension. Attempting to remove grease in negligence of following rules may cause the grease valve to blow off, resulting in serious accident.
- Tension adjusting grease valve should not be loosened by more than one turn. Grease valve may blow off otherwise.
- When adjusting the tension, do not position yourself directly in front of the valve to avoid the risk.
  - ★ See “MAINTENANCE, 8.4 [3] Check and adjust rubber crawler tension” for detail.

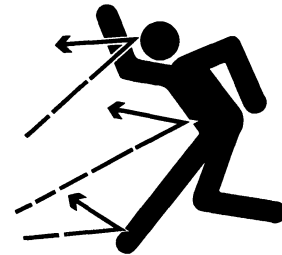

A0055200

**High Pressure Hose: Use care**

Leakage of oil from high pressure hoses may cause injury due to fire or malfunctioning of systems. Whenever damage in hoses or loosened bolts are found, discontinue your work and contact your dealer for repair.

- For replacement of high pressure hoses, skilled technic is required. Further, tightening torque has been established according to type and size of hoses. Do not perform repair work by yourself.
- When situation such as follows is found, contact your dealer for repair.
  - Damage of or leakage at hose metal piece.
  - Sheath worn or broken or wire reinforcement layer exposed.
  - Partly expanded sheath
  - Sign of twist or collapse at moving part of hose
  - Foreign matter buried under sheath
  - Deformed hose metal piece.
- Replacement should be made with one hose at a time to avoid error.

**Care to be taken in connection with high pressure oil**

When inspecting or replacing high pressure piping or hose, unless you make sure that the pressure has been released, serious accident may result. Strictly observe following:

- Do not proceed with inspection or replacement work before pressure is eliminated.
- Wear protection goggles and leather gloves.
- If there is leakage in piping or hose, such piping, hose or its vicinity is wet. Check for crack in piping and crack or expansion in hose. If it is difficult to identify, be sure to contact your dealer for repair.
- Leakage of high pressure oil from any small hole can hit you and cut your skin or make you blind. If you incur serious injury on your skin or in your eyes with high pressure oil, wash it off with water and see doctor promptly.



A0055180

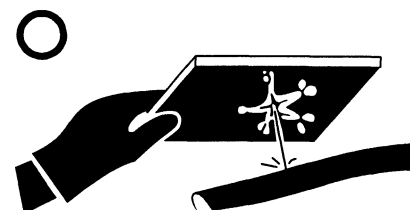

A0055190

### Care to be taken in connection with high temperature

Immediately after engine is shutdown, engine, various oil, exhaust manifold and muffler remain hot.

Performing service work under such condition, including removing cap or replacing oil, water or filter will result in scalding. Wait for temperature to drop before proceeding with service in accordance with procedures shown in this manual such as follows:

- ★ See “MAINTENANCE, 8.5 [3] Check oil level in engine” for detail.
- ★ See “MAINTENANCE, 8.5 [7] Check oil level in hydraulic tank” for detail.
- ★ See “MAINTENANCE, 8.10 [1] Chang engine oil and replace filter cartridge” for detail.
- ★ See “MAINTENANCE, 8.10 [3] Replace hydraulic oil return filter” for detail.
- ★ See “MAINTENANCE, 8.11 [3] Chang oil in hydraulic tank” for detail.

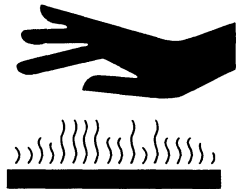

A0055050

### Checking to be performed after inspection and service

Failure to complete the required service items or failure to verify the function or actuation of serviced location, may cause unexpected trouble to occur, resulting in serious accident. Observe following strictly:

- Checking after stopping engine:
  - Check for any neglected inspection and service location.
  - Check for proper execution of required inspection and service.
  - Check for tools or parts dropped. It is dangerous particularly if they are dropped internally or caught by link mechanism of levers.
  - Check for water leakage, oil leakage or bolt not tightened.
- Checking with engine running
 

For checking engine while it is running, see Paragraph “Service work with engine running should be performed with 2 or more persons” and pay sufficient attention for your safety.

  - Check the inspected and serviced location for normal actuation.
  - See if oil leakage does not occur when engine speed is increased and load is applied to hydraulic system.

### Care to be taken about waste treatment

In order to avoid polluting the environment of area where people and animals live, observe following strictly:

- Do not dispose waste oil to sewerage system or river.
- Be sure to dispose oil from machine to container. Do not dispose it directly to ground.
- For disposal of harmful matter including oil, fuel, solvent, filter and battery, observe applicable laws and regulations.

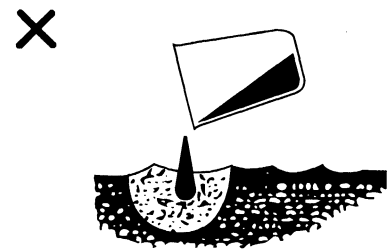

A0055220

### 6. Location for Affixing Caution Plates

Keep these labels always clean. If it comes off, affix with new one. There are other plates than those shown below. Take care of them in the same manner.

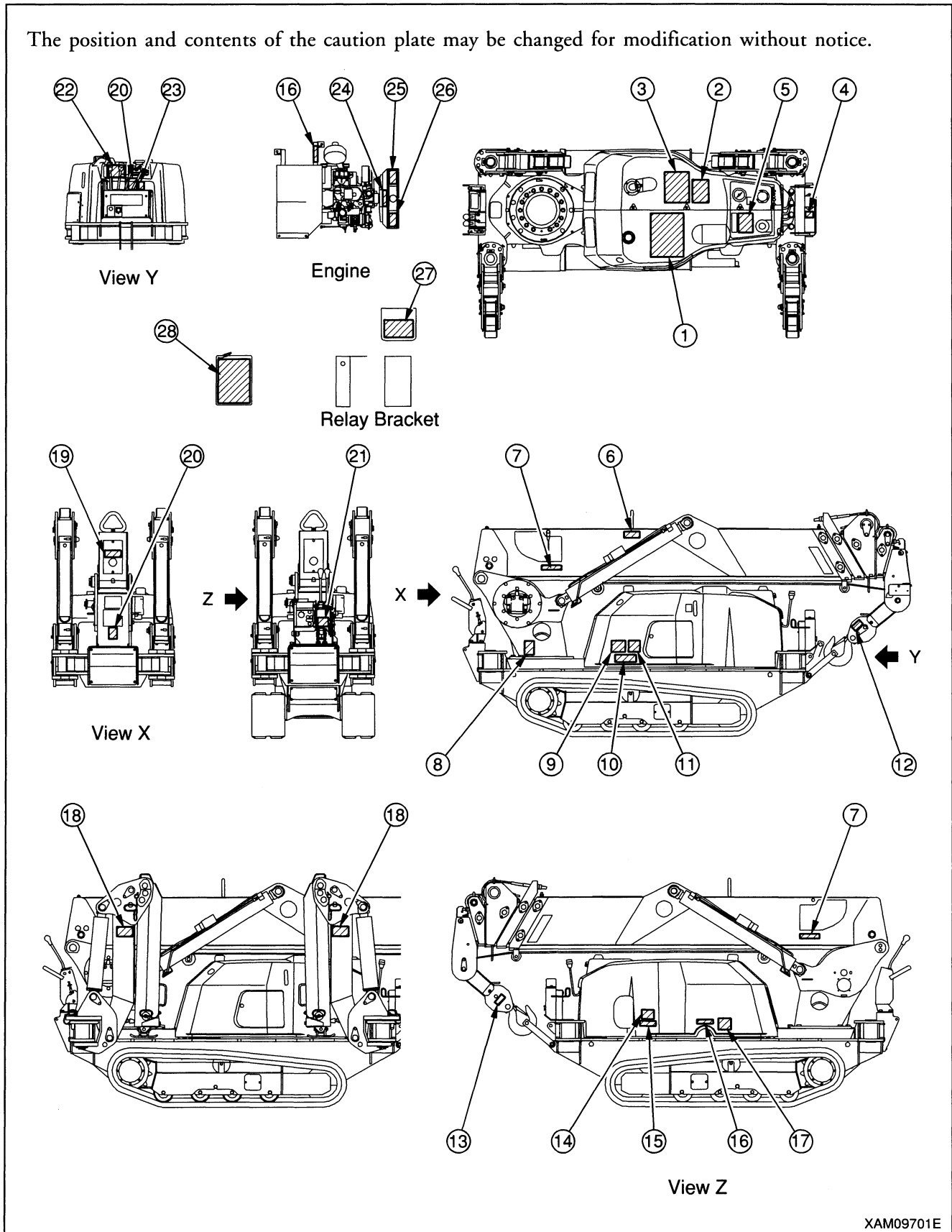

XAM09701E

① Warnings for crane performance and outrigger (353-2082900)

### MC-285C Working Radius/Lifting Height Chart

1. This chart does not reflect any bending of boom.  
 2. Curve 3-represents the case where one-half of  $\blacktriangledown$  mark is exposed from 2st stage boom  
 3. Curve 4-represents the case where second of  $\blacktriangledown$  mark is exposed from 2st stage boom.

### WARNING

1. Use a leveling instrument to position your machine horizontally on level and hard ground.
2. Use outriggers extended to the maximum, in principle.
3. For setting insert retainer pins for positioning pins.
4. For traveling, be sure to stow outriggers.

### CAUTION

1. For crane work, extend four outriggers so that load is uniformly applied and tracks are lifted off the ground by about 80mm.
2. Do not perform crane work with tracks grounded, because it may cause damage to undercarriage. Do not lift your machine excessively for increasing the lifting height over the ground level, which will cause the stability to be reduced. Work within the specified values.

G. L.

### MC-285C Rated Total Load Chart

Rated Total Load Chart with outrigger extended to maximum								Rated Total Load Chart with outrigger extended to other than maximum							
2.535m/4.075m Boom		5.575m Boom		7.075m Boom		8.575m Boom		2.535m/4.075m Boom		5.575m Boom		7.075m Boom		8.575m Boom	
Working Radius (m)	Rate Total Load (t)	Working Radius (m)	Rate Total Load (t)	Working Radius (m)	Rate Total Load (t)	Working Radius (m)	Rate Total Load (t)	Working Radius (m)	Rate Total Load (t)	Working Radius (m)	Rate Total Load (t)	Working Radius (m)	Rate Total Load (t)	Working Radius (m)	Rate Total Load (t)
1.4 or shorter	2.82	3.0 or shorter	1.22	3.6 or shorter	0.82	4.0 or shorter	0.55	1.5 or shorter	1.72	3.0 or shorter	0.51	3.6 or shorter	0.4	4.0 or shorter	0.33
1.5	2.52	3.5	0.97	4.0	0.74	4.5	0.4	2.0	1.07	3.5	0.41	4.0	0.33	4.5	0.28
2.0	1.92	4.0	0.78	4.5	0.58	5.0	0.34	2.5	0.63	4.0	0.33	4.5	0.28	5.0	0.23
2.5	1.57	4.5	0.63	5.0	0.48	5.5	0.3	3.0	0.52	4.5	0.28	5.0	0.23	5.5	0.18
3.0	1.22	5.0	0.53	5.5	0.43	6.0	0.27	3.5	0.43	5.0	0.23	5.5	0.18	6.0	0.16
3.5	0.97	5.205	0.53	6.0	0.38	6.5	0.23	3.705	0.35	5.205	0.2	6.0	0.16	6.5	0.15
3.705	0.92			6.5	0.35	7.0	0.2					6.5	0.15	7.0	0.1
				6.705	0.33	7.5	0.18					6.705	0.14	7.5	0.08
						8.0	0.15							8.0	0.07
						8.205	0.15							8.205	0.06

1. The Rated Total Load Chart is based on actual working radius with the bending of boom attributable to load reflected and is shown with the mass of hook (20kg) included when.
2. If third stage boom is extended to any extent, work should be performed within the capacity for "Boom 5.575m".
3. If one half or more of the mark  $\blacktriangledown$  is exposed from second boom, work should be performed within the capacity for "Boom 7.075m".
4. If one half or more of the second mark  $\blacktriangledown$  is exposed from second stage boom, work should be performed within the capacity for "Boom 8.575m".
5. Rough operation of crane is extremely dangerous, Stick to safe operation.

### OUTRIGGERS EXTENDED TO MAXIMUM

With the inner box pulled out to the position of Maximum Extension, positioning pin for outrigger base is set Maximum Position.

1. If the position of inner box or outrigger base positioning pin is retracted by even one step, your work should be performed in accordance with the value for other than maximum extension.
2. When swinging with a load suspended, stability may vary between the front and rear or right and left side of the machine. Perform your work with the working radius reduced to as short as possible and paying attention to a possibility of tipping over.
3. For any crane work, use outriggers to maintain the machine body horizontally.
4. When setting up outrigger excepting for above drawing, work should be performed in accordance with the "Zone where crane work is prohibited".

353-2082900

## ② Warnings for crane tipping over (349-4427100)

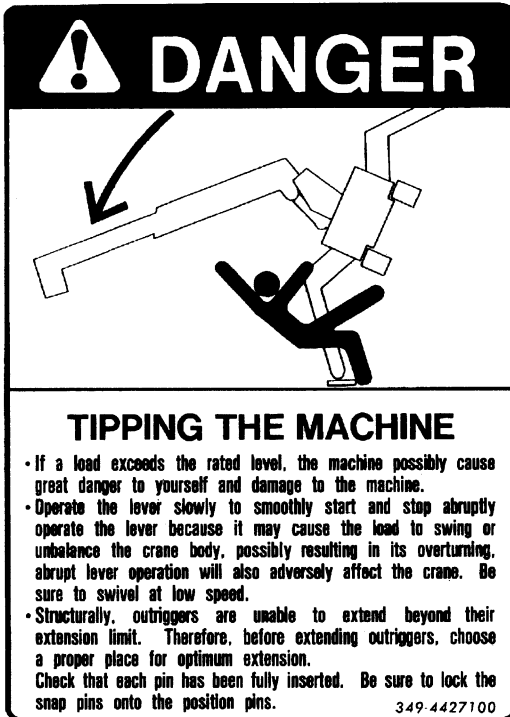

- ④ Cautions for over-hoist alarm system (353-4488500)  
 ★ This caution plate is not provided in the specifications including the moment limiter.



- ⑤ Cautions for boom hitting to outrigger (353-4488700)

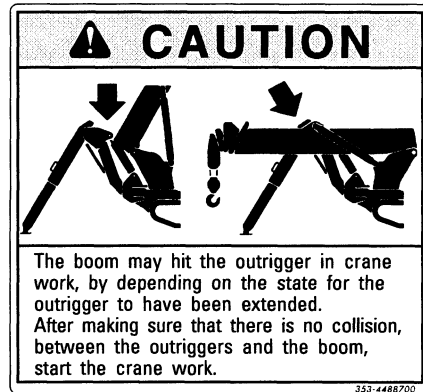

- ⑥ Display for machine weight (353-4479500)



- ⑦ Display for minimum lifting load (353-4479600)

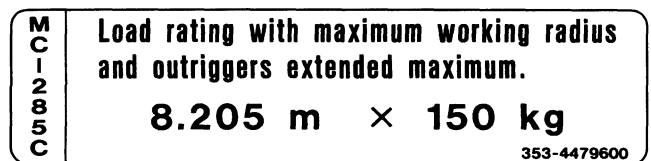

- ⑧ Watch for crane approach (349-4422000)



- ⑨ Caution (553-4268000)



- ⑩ Warning for electric shock (553-4267300)

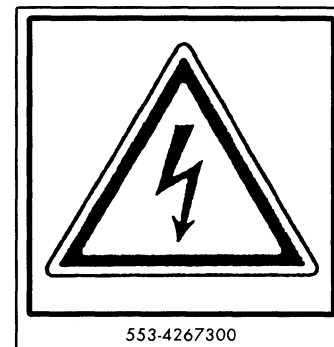

- ⑪ Cautions for rotating parts (553-4268600)

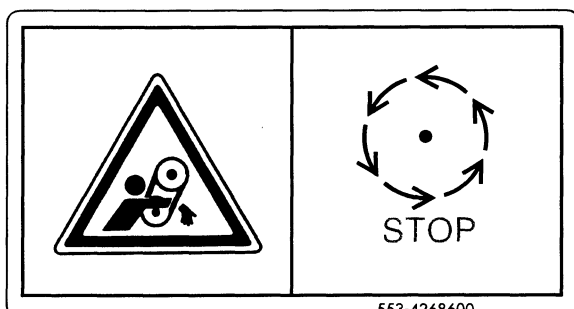

⑫ Precautions for rotating parts (553-4267400)



⑬ Display for maximum lifting load (353-4488800)



⑭ Cautions for diesel fuel (553-4267100)

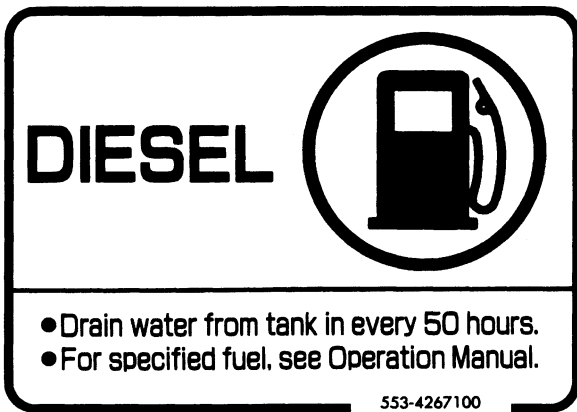

⑮ Fire strictly prohibited (349-4427500)

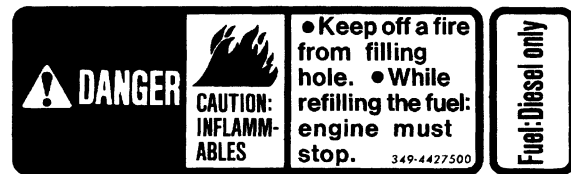

⑯ Cautions for hot muffler (349-4427800)



⑰ Precautions for burns (553-4267700)



⑱ Warnings for outrigger pin hole (349-4426900)

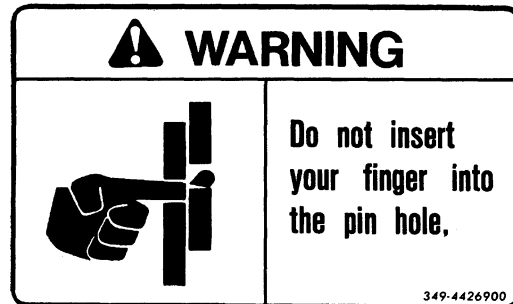

⑲ Warnings for travelling on slope (353-4488400)

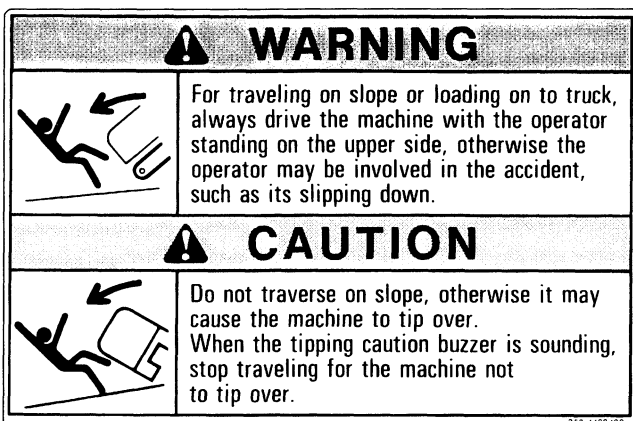

⑳ Cautions for operation and service work (893-4239100)

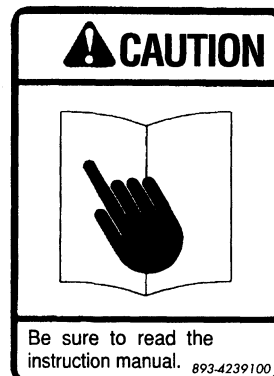



②① Warnings for travelling on slope (353-4488600)

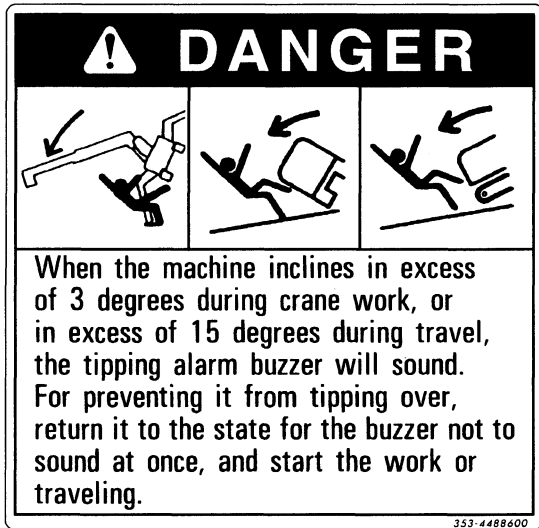

②② Warnings for over-hoist alarm (350-4432100)

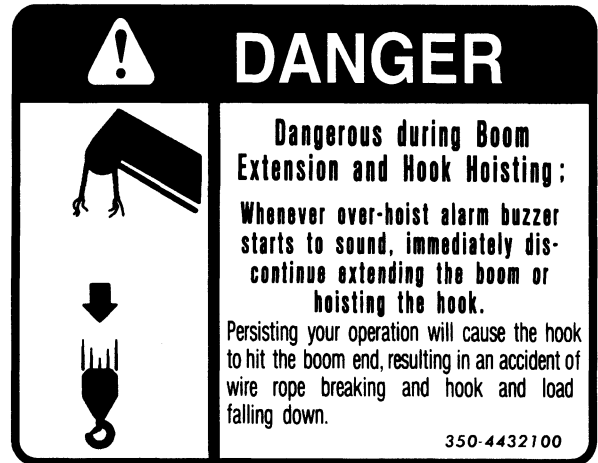

②③ Cautions for main switch (349-4421400)

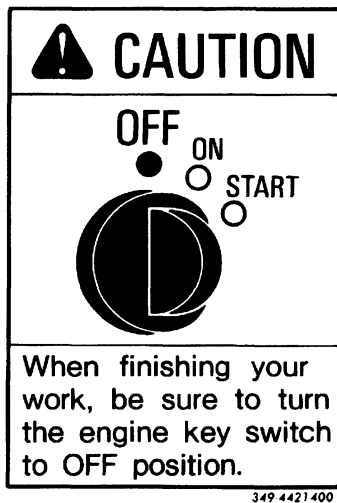

②④ Warnings for radiator (349-4427300)



②⑤ Warnings for rotating belt (349-4427700)

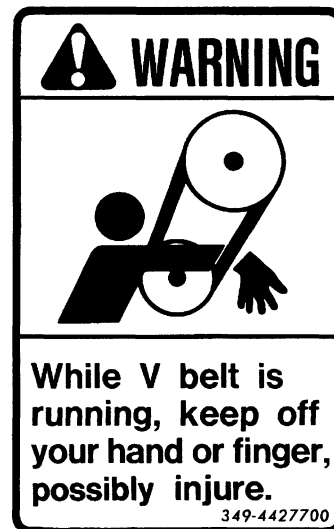

②⑥ Warnings for rotating fan (349-4427600)

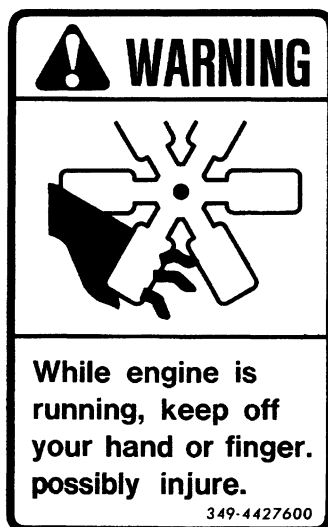

②⑦ Cautions for emergency stop (349-4420100)

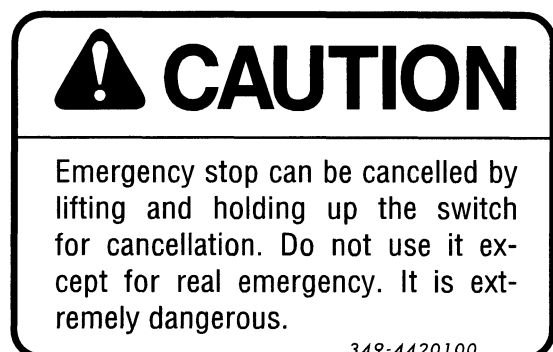

⊗ General rules for use (Card type) (353-2083000)

○ MINI-CRAWLER CRANE MC285GRM (-E)

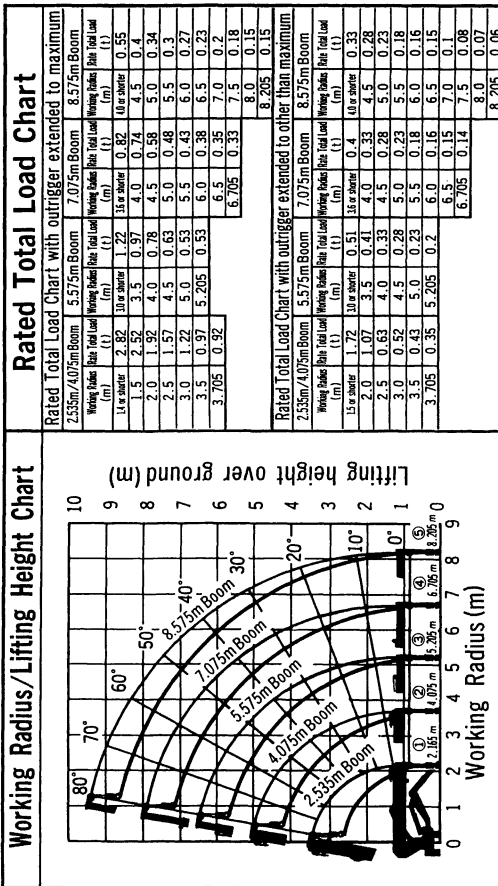

1. The Rated Total Load Chart is based on actual working radius with the bending of boom attributable to load.  
 2. If third stage boom is extended to any extent, work should be performed within the capacity for "Boom 5.575m".  
 3. If one half or more of the mark is exposed from second boom, work should be performed within the capacity for "Boom 7.075m".  
 4. If one half or more of the second mark is exposed from second stage boom, work should be performed within the capacity for "Boom 8.575m".  
 5. Rough operation of crane is extremely dangerous. Stick to safe operation.

OUTRIGGER EXTENDED TO MAXIMUM

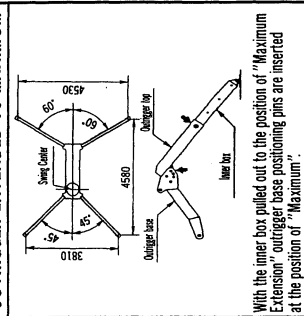

With the inner box pulled out to the position of "Maximum Extension" outrigger base positioning pins are inserted at the position of "Maximum".

⚠ If the position of inner box or outrigger base positioning pin is retracted by even one step, your work should be performed in accordance with the value for other than maximum extension.  
 ⚠ For each pattern of outrigger extension, your work should be performed so that the load is located within blue range. In red range, the crane may tip over.  
 ⚠ Of the four outriggers, make sure that the two in either front or rear or the two on either right or left side are set to the standard extension (front 60 degrees and rear 45 degrees as shown sketches) to the left. Under this arrangement, even if two outriggers are set to standard positions, your work should be performed in accordance with the Rated Total Load for other than maximum.

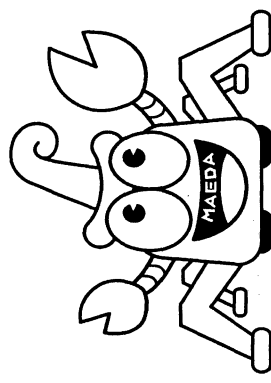

**PERFORMANCE**

(1) Even with a same working radius, performance will vary depending on the boom length in use. Also, even with very minor change in the working radius, lifting capability changes in great deal.  
 (2) Lifting capability of the crane becomes smaller as the working radius grows greater.  
 (3) Depending on how outrigger is extended, lifting capability changes.  
 (4) Depending on the direction of boom (forward, lateral, backward), stability changes. Stability is worst when boom is in lateral position. When swinging from forward to lateral position, strictly observe the Rated Total Load Chart values.

Rules for Operating the Crane

- Read carefully and understand the instruction Manual before starting your work.
  - Make sure to conduct the pre-work check-up.
  - For performing crane work, always place the machine in level by using outrigger.
  - Use the outriggers in maximum extension in principle.
  - Rubber tracks should be lifted off the ground by about 80mm.
  - Try not insert your finger to pin holes of the outriggers.
  - Insert the positioning pins (retainer pins) when setting the outriggers.
  - Close the switch of over-hoist alarm and make sure that the buzzer sounds.
  - For working with this crane, operator, qualification is required by local authority with respect to its operation as well as wiring work.
- (2) During Work
- Stability changes depending on outrigger placement and ground conditions. Do not perform crane work under hazardous conditions such as float of outrigger leaving ground. Be sure to observe the Rated Total Load Chart values.
  - Avoid over-loaded work as it may expose the machine to tipping over or any other damage.
  - Performing any crane work with engine running at high speed is dangerous, because work speed will also become light.
  - During crane work, use care not to allow the load to sway.
  - Do not perform any lateral or longitudinal dragging or slant lifting of your load, as it may damage your crane.
  - Do not leave your crane with any load suspended.
  - Do not allow anyone to enter underneath the boom during crane operation.
  - Watch for over-hoisting while hoisting or extending your boom.
- As you approach over-hoisted condition, the over-hoist alarm will be actuated, causing the buzzer to sound. Use the hook well lowered so that it does not cause the buzzer to sound.
- (3) During Travel
- For travelling, be sure to stow the outriggers and lock the fork to its holder.
  - Reduce speed for making turn or traveling over bad road surface.
  - For parking on slope, be sure to engage chocks.
  - For travelling on stop or loading on to truck, always drive the machine with the operator standing on upper side.
- (4) After Work
- After completion of your work, always turn off your main switch(key switch).
- (5) Inspection and Service
- Conduct pre-work inspection as well as voluntary periodical inspection such as monthly and annual.
  - If any deficiency should be detected through such check and inspection, go ahead and correct it immediately.
  - In accordance with the standards stipulated in instruction Manual, services such as replacement of consumables, lubrication and replenishment or replacement of lubricant should be conducted.

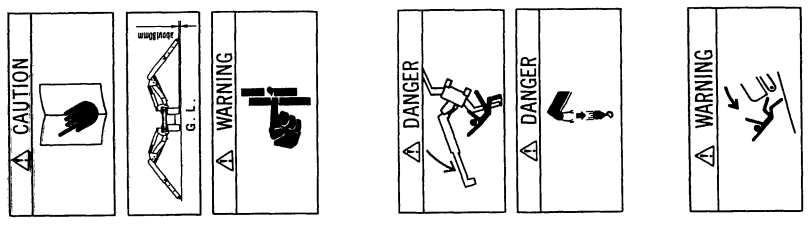

OTHER RULES

- Improper use of this crane may result in serious accident involving death or injury.
- Before starting your crane work, read the instruction Manual and learn the safe manner of its operation.

## OPERATION

1. Nomenclature of Components .....	3- 2
2. Operation and Controls .....	3-16
3. Handling of Rubber Track .....	3-69
4. Handling of Wire Rope .....	3-73
5. Transport .....	3-75
6. Handling in Cold Climate .....	3-78
7. Long Term Storage .....	3-80
8. Handling of Battery .....	3-81
9. Measures to be Taken in Case of Abnormality .....	3-85

# 1. Nomenclature of Components

## 1. Nomenclature of Components

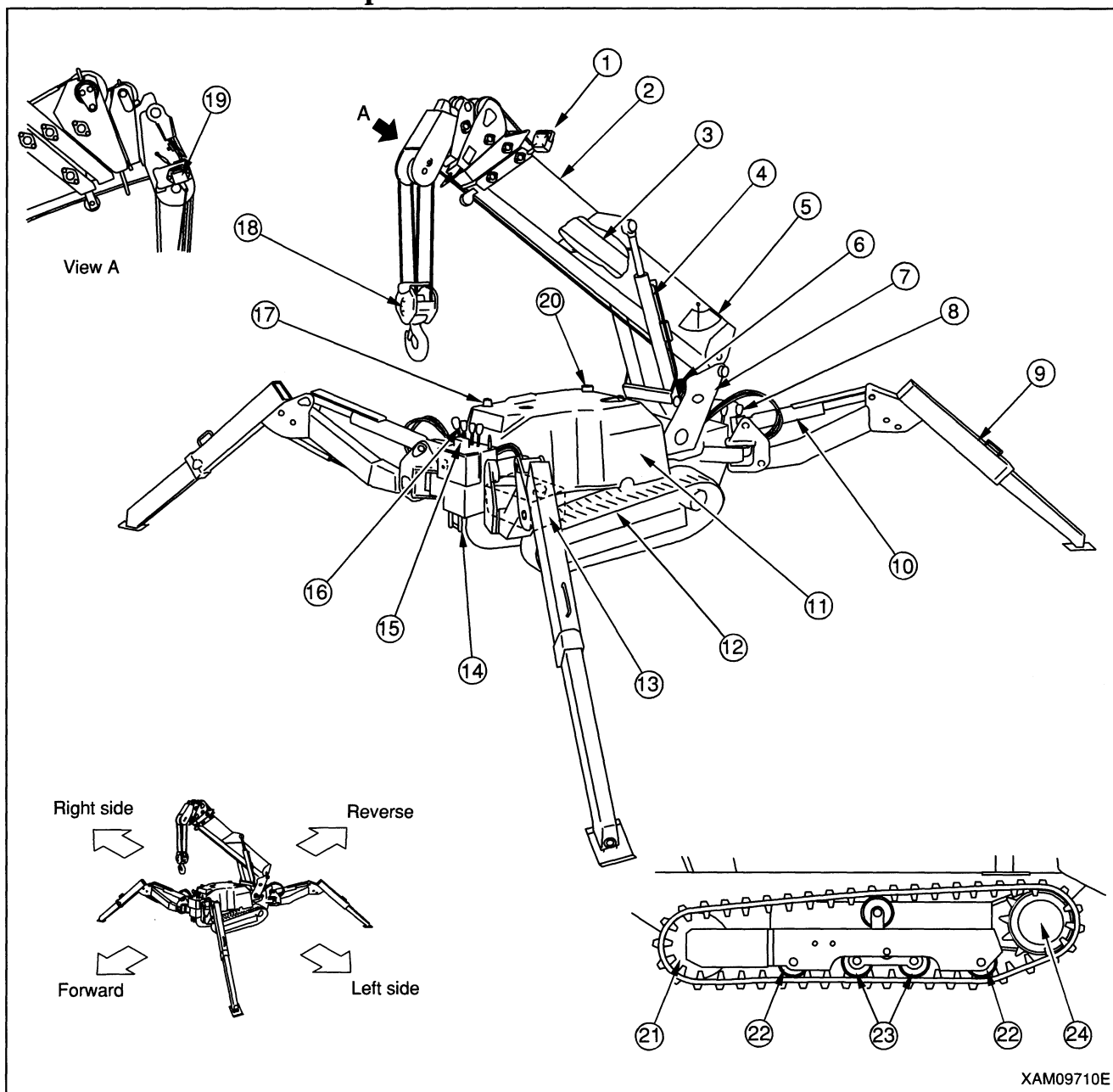

XAM09710E

- |   |                                 |
|---|---------------------------------|
| ① Working light                             | ⑬ Fuel tank (under the engine)  |
| ② Boom                                      | ⑭ Hook hanger                   |
| ③ Boom telescope cylinder (inside the boom) | ⑮ Over-hoist alarm buzzer       |
| ④ Boom derrick cylinder                     | ⑯ Crane control                 |
| ⑤ Load indicator                            | ⑰ Outrigger mode indicator lamp |
| ⑥ Winch                                     | ⑱ Hook block                    |
| ⑦ Post                                      | ⑳ Over-hoist alarm system       |
| ⑧ Travel control                            | ㉑ Hydraulic oil tank            |
| ⑨ Outrigger                                 | ㉒ Front idler                   |
| ⑩ Outrigger cylinder                        | ㉓ Track roller                  |
| ⑪ Machinery cover                           | ㉔ Tandem track roller           |
| ⑫ Rubber track                              | ㉕ Travel motor and sprocket     |

**1.2 Nomenclature of travel control components**

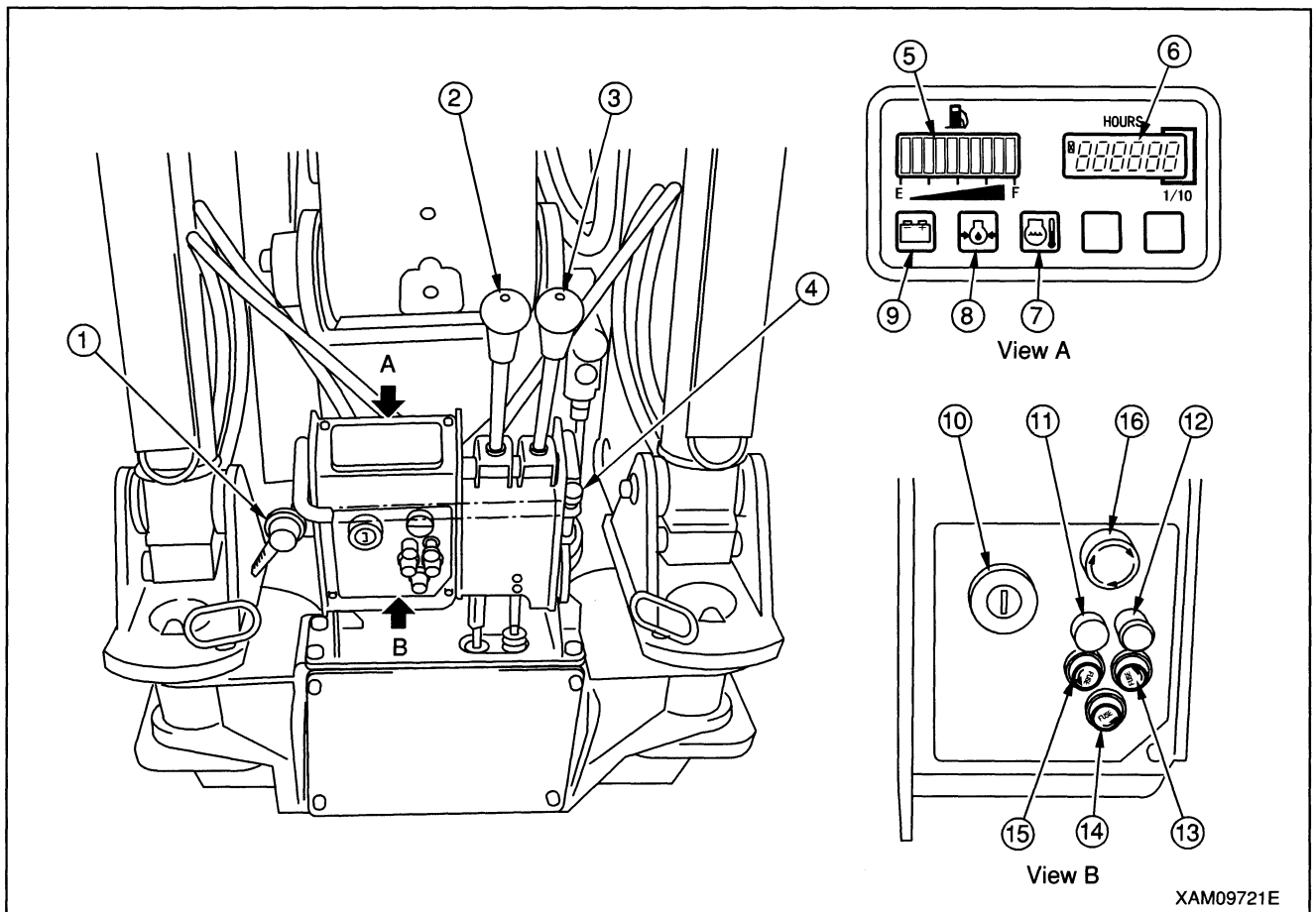

- |                                    |  |
|------------------------------------|--|
| ① Accelerator lever                | ⑩ Main starter switch  |
| ② L.H. travel lever                | ⑪ Horn switch  |
| ③ R.H. travel lever                | ⑫ Working light switch                                       |
| ④ Travel stand locking lever       | ⑬ Fuse (15A)   |
| ⑤ Fuel level gauge                 | ⑭ Fuse (30A)   |
| ⑥ Hour meter                       | ⑮ Fuse (15A)   |
| ⑦ Engine water temperature monitor | ⑯ Emergency engine stop switch<br>(For moment limiter spec.) |
| ⑧ Engine oil pressure monitor      |  |
| ⑨ Charge monitor                   |  |

### 1.2.1 Control levers

#### [1] Accelerator lever

This lever is to be used for adjusting engine speed or output.

- Low idling: Push the lever downward.
- Full speed: Pull the lever upward.

#### NOTES

- At the desired engine speed for your work, release the lever. It will stop at that position.
- Accelerator lever is also provided on the crane control panel.

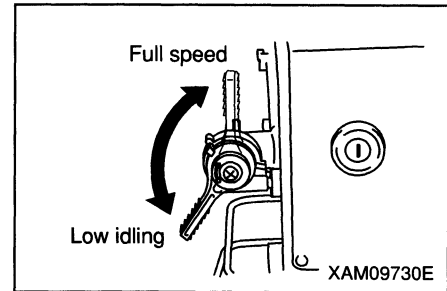

#### [2] Travel levers, left and right

Used for traveling forward/backward, stopping, swinging and adjusting travel speed.

- Forward travel: Push both of the left and right levers forward simultaneously.
- Neutral: Take your hands off both of the left and right levers simultaneously. Levers will return to neutral automatically, causing the machine to stop.
- Reverse travel: Pull back both of the left and right levers simultaneously.
- Left turn: Release the left hand side lever.
- Right turn: Release the right hand side lever.
- Spin turn: Move left and right levers respectively in opposite direction. Left and right tracks will respectively rotate in opposite direction to make the spin turn.

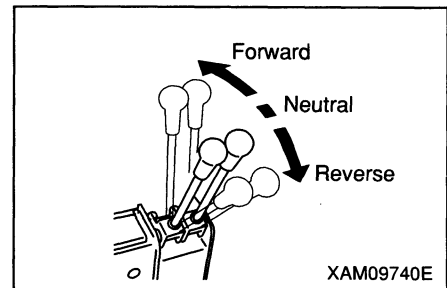

**[3] Travel lever stand**

**! WARNING**

- **Before setting the travel lever stand to “Travel Position”, be sure to stow the crane and let the machine assume travel position.**  
**Travelling with the crane not in travel position, may cause it to tip over and serious accident be incurred.**
- **When pulling up the travel stand locking lever, be careful not to contact the travel lever, as it may cause the undercarriage to move.**

This stand is to be used for switching between travel control and crane control.

- **For traveling:**  
 Pull up the locking lever ② before erecting the entire lever stand ① forward to the “Travel Position”. The machine is in “Travel Position” when the bottom end of locking lever ② fits into the guide groove ④.
- **For crane operation:**  
 Pull up the locking lever ② before pressing the whole lever stand ① down to the “Crane Work Position”. The machine is in “Crane Work Position” when the end of locking lever ② fits into its place before the stopper ⑤.

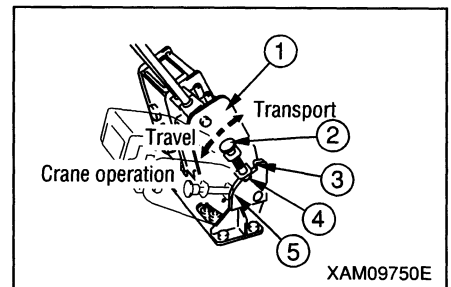
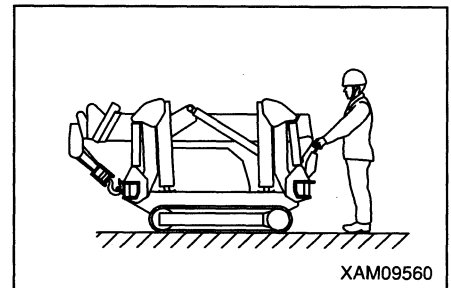

**NOTES**

- When the travel lever stand is in Travel Position, only the travel operation is possible. Operating the crane or outrigger control lever under such status. will cause the crane to not respond.
- When the travel lever stand is in Travel Position, under such status, radio control for crane or outrigger does not actuate the crane at all.
- For actuating crane or outrigger motion, place the travel stand in “Crane Work position”.

- **For transport or storage:**  
 With the locking lever ② pulled up, erect the entire lever stand ① forward. The machine is in Transport Position when the end of locking lever ② fits in the position before the stopper ③ at guide top.

**NOTES**

- When you place the travel stand in Transport Position, the back end of travel lever stand may be stowed within the rear end of the carrier. Place the stand in this position when you desire to reduce the overall length to the minimum due to storage place or the like.

1.2.2 Switches

[1] Main starter switch

**CAUTION**

When you finish your work, be sure to turn the main starter switch to OFF position.

Used for starting and stopping the engine.

- PRE-HEAT: When starting the engine in low temperature, set the key to this position.
- OFF: At this position, key can be inserted or removed and switches of all the electric systems go off and engine comes to stop.
- ON: Power flows to all the circuits.
- Start: At this position, engine starts. Once the engine starts, take your hand off the key. The key will automatically return to ON position.

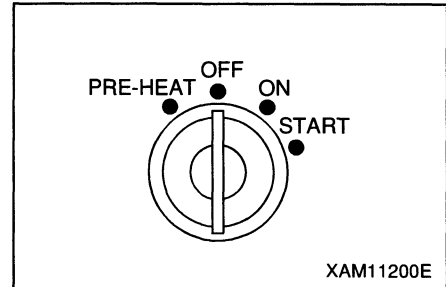

[2] Working light switch

This switch is to be used for turning on the working light at the machine front.

- Turning on: Pull out the switch.
- Turning off: Push in the switch.

**NOTES**

When the starter switch is at OFF position, the working light will not go on even if the switch is pulled out.

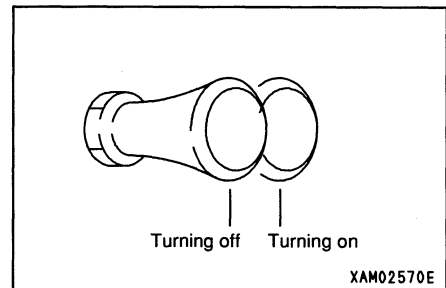

[3] Horn switch

Used to sound horn.

- To sound the horn: Press the switch.

**NOTES**

- Horn sound stops as you take your finger off the switch.
- Horn switch is provided on the crane operating side as well.

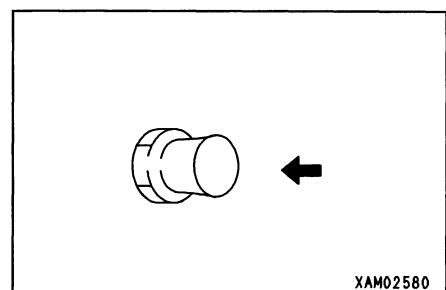

[4] Emergency engine stop switch (For moment limiter spec.)

Use this switch to stop the engine with trouble having developed on the machine.

- Switch ON: Pressing the switch causes engine to stop.
- Switch OFF: Turn the switch to right. It will return to original position.

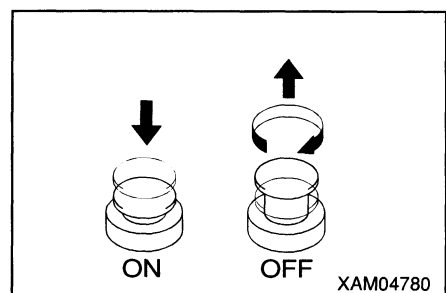



**1.2.3 Meters and switches**

**[1] Fuel gauge**

This indicates the amount of fuel remaining in the fuel tank.  
 Placing the starter switch at ON position causes the bar lamps to light to indicate the remaining fuel level.  
 Lighting of one bar lamp at the E side during operation indicates that little fuel is left.  
 Stop operation at once for refueling.

**NOTES**

- After finishing the work of a day, fill up the tank (until all bar lamps (10) light).
- Even if you place the starter switch at ON position, the fuel level may not be correctly indicated. This is completely normal.

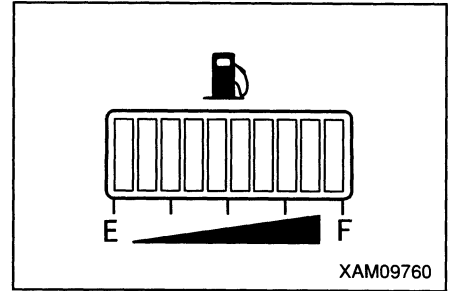

**[2] Hour meter**

This meter indicates total hours the machine has been operated.  
 Set up your serving intervals accordingly. So long as the engine is running, the meter gains even while the machine is idle.  
 Regardless of engine speed, the meter gains by the increment of one when it has run for an hour.

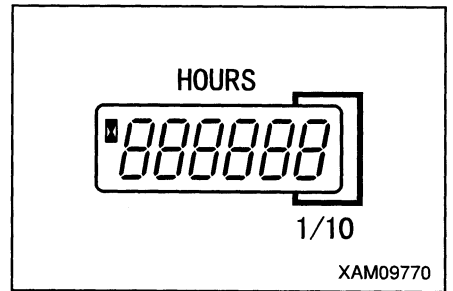

**[3] Engine water temperature monitor lamp**

Warns you of abnormal engine coolant temperature.  
 It is normal if this lamp is off during operation.  
 The temperature exceeds the normal range if this lamp lights on during operation.  
 If it happens, decrease engine rotation down to the low idling level at once and wait until the monitor goes off (engine coolant temperature lowers to the specified level).  
 Then, stop operation to check the radiator for leakage, radiator core for clogging, and alternator belt for damage and tension.

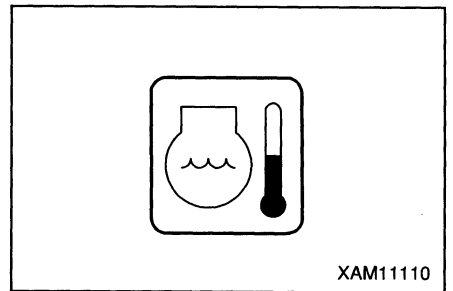

**[4] Engine oil pressure monitor lamp**

Warns you of reduction of engine oil pressure.  
 It is normal if it lights by placing the main starter switch at ON position and it goes off as engine rotation increases after starting the engine.  
 Engine oil pressure is too low if it lights during operation.  
 If it happens, stop operation at once, check the engine oil filter for clogging and engine oil level.

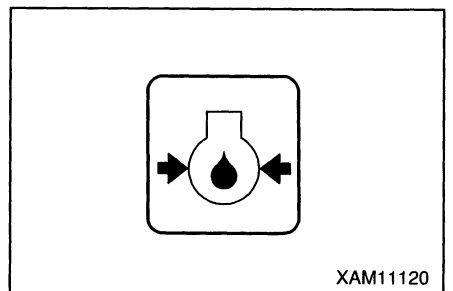

**[5] Charge monitor lamp**

This indicates the condition of the charging system.

When the starter switch is turned ON, it lights up, and after the engine is started and the engine speed rises, it should go out.

If it lights up during operations, there is an abnormality in the charging system.

Stop operations immediately and check the tension of the alternator belt.

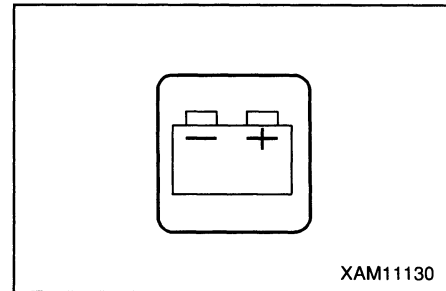
**[6] Fuse****CAUTION**

**For checking or replacing a fuse, make sure that main starter switch is at OFF position.**

**CAUTION**

Fuse protects electric components and wiring from burning.

- Tubular fuse is in use. Be sure to replace it when it is covered with whitish powder due to corrosion.
- When any fuse has blown, be sure to check the relevant circuit and correct it before replacing the fuse.
- Replace any fuse with tubular fuse of the same capacity.

Systems and capacities of fuses are as follows:

- Fuse ① (15A): For light, horn and crane control systems.
- Fuse ② (10A): For Meter panel, fuel pump and slope gauge.
- Fuse ③ (30A): For engine.

1. Turn the fuse holder on control panel counterclockwise and take it out.
2. Check and replace fuses contained in the removed fuse holder.
3. Install new or checked fuse to the holder and turn it clockwise to tighten.

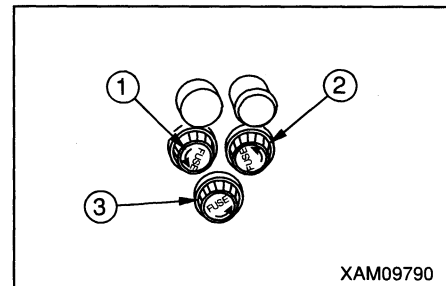

1.3 Nomenclature of crane control components

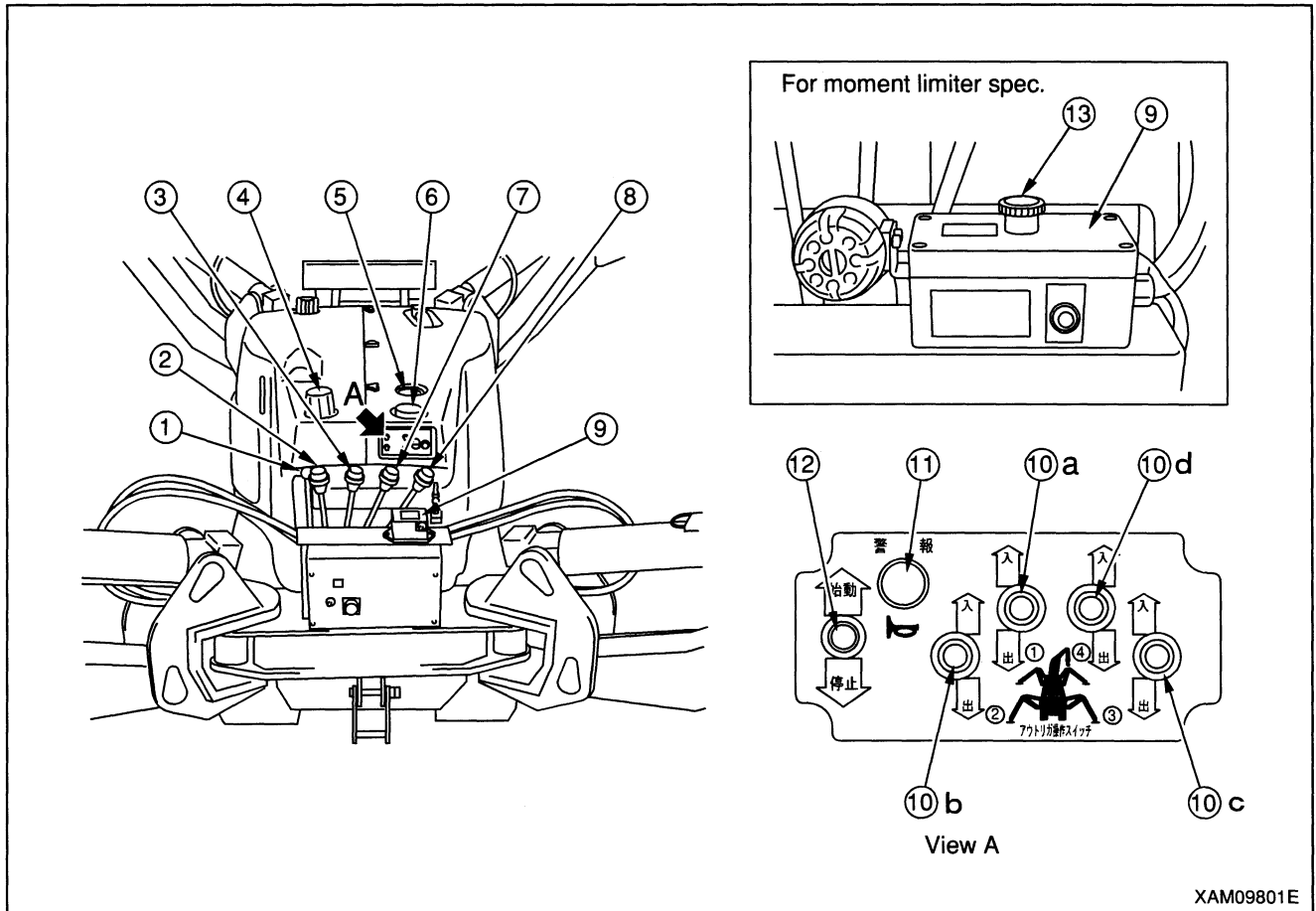

XAM09801E

- ① Accelerator lever
- ② Swing lever
- ③ Boom telescope lever
- ④ Outrigger mode indicator lamp
- ⑤ Load meter
- ⑥ Level instrument
- ⑦ Winch lever
- ⑧ Boom hoist lever
- ⑨ Over-hoist alarm buzzer

- ⑩ Outrigger control switch
  - (a) Outrigger ① control switch
  - (b) Outrigger ② control switch
  - (c) Outrigger ③ control switch
  - (d) Outrigger ④ control switch
- ⑪ Horn switch
- ⑫ Auxiliary starter switch
- ⑬ Emergency engine stop switch  
(For moment limiter spec.)

1.3.1 Control levers

[1] Accelerator lever ①

This lever is to be used for adjustment of engine speed or output.

- Low idling: Push the lever forward.
- Full speed: Pull back the lever.

**NOTES**

- At the desired engine speed for your work, release the lever. It will stop at that position.
- Accelerator lever is also provided on the crane control panel.

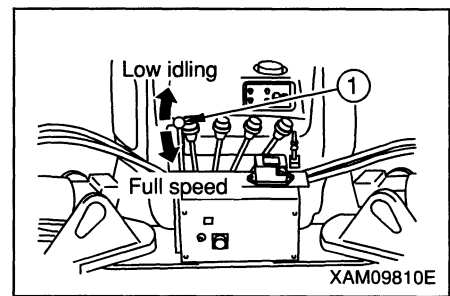

[2] Swing lever ②

Used for having boom post of the crane swing.

- Counterclockwise swing: Push the lever forward (to Left).
- Neutral: Take your hand off the lever, which will return to Neutral position, causing the swing to stop.
- Clockwise swing: Pull back the lever (to Right).

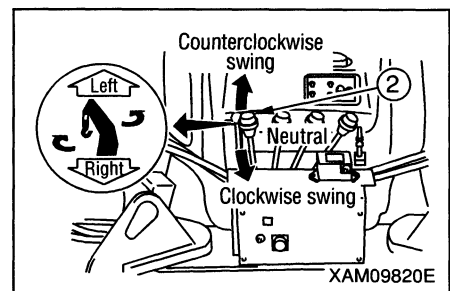

[3] Boom telescoping lever ③

Used for telescoping the boom.

- Extension: Push the lever forward (to Extend).
- Neutral: Take your hand off the lever, which will return to Neutral position, causing the telescoping of the boom to stop.
- Retraction: Pull back the lever (to Retract).

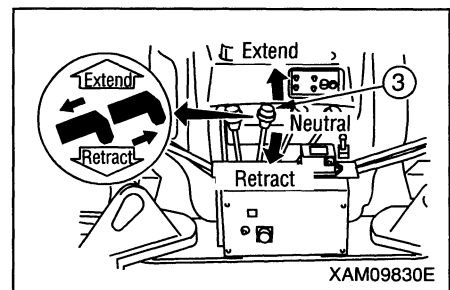

[4] Winch lever ⑦

Used for hoisting the hook of crane.

- Lowering: Push the lever forward (to Down)
- Neutral: Take your hand off the lever, which will return to Neutral position, causing the brake to be automatically applied and hoisting and lowering of the hook block to stop.
- For hoisting: Pull back the lever (to Up).

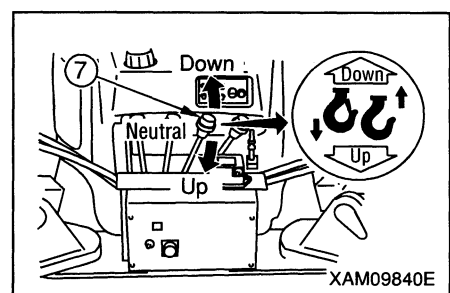

[5] Boom hoist lever ⑧

Used for hoisting the boom.

- Lowering: Push the lever forward (To Lower).
- Neutral: Take your hand off the lever, which will return to Neutral causing the hoisting of boom to stop.
- Hoisting: Pull back the lever (to Hoist).

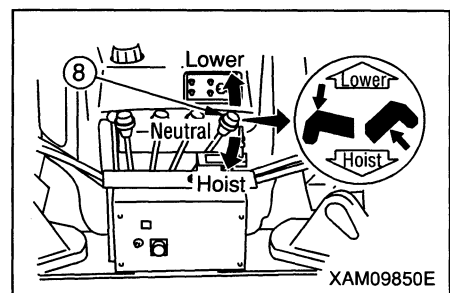

**1.3.2 Switches**

**[1] Outrigger control switch**

Used for setting and stowing away the outrigger.

This machine has 4 outriggers (① – ④), which can be controlled individually or simultaneously.

- To retract: Push the switch upward. Outrigger cylinder will be retracted and the outrigger can be stowed.
- Neutral: Take your finger away from the switch, which will return to Neutral position and telescoping of the cylinder will discontinue.
- To extend: Push the switch downward. Outrigger cylinder will be extended and the outrigger can be placed.

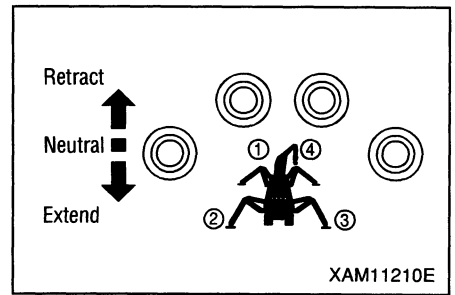

**NOTES**

While the outrigger control switch is being operated, outrigger mode indicator lamp flashes and warning buzzer sounds intermittently.

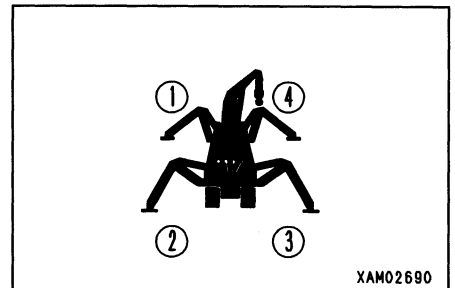

**[2] Auxiliary starter switch**

**CAUTION**

**The auxiliary starter switch functions only while main starter switch at travel control is in ON position.**  
**To start-up engine using the auxiliary starter switch, the main starter switch must remain at ON position.**

This switch is to be used, to start or stop the engine while crane or outrigger operation is going on.

- For starting: Push the switch upward and engine will start. Once the engine is started, release the switch.
- For Neutral: Release the switch and the switch will return to Neutral.
- For stopping: Push the switch downward and the engine will stop. Do not release the switch until the engine comes to stop.

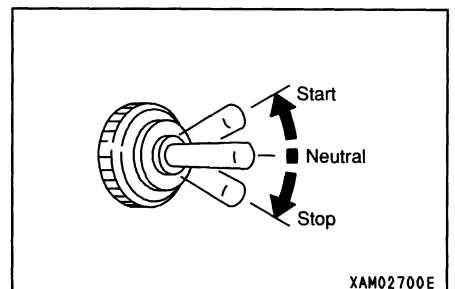

**[3] Horn switch**

Used to sound the horn.

- To sound the horn: Press the switch.

**NOTES**

- Horn will stop sounding as soon as you release the switch.
- Horn switch is provided at the travel control panel side as well.

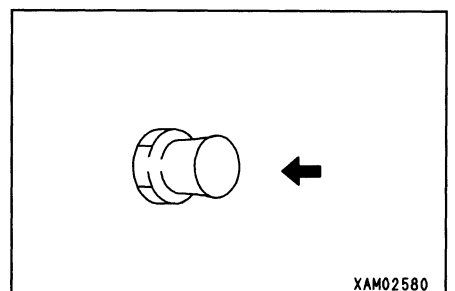

**[4] Emergency engine stop switch (For moment limiter spec.)**

Use this switch to stop the engine with trouble having developed.

- Switch ON: Pushing the switch causes engine to come to stop.
- Switch OFF: Turning the switch clockwise causes the switch to return to original position.

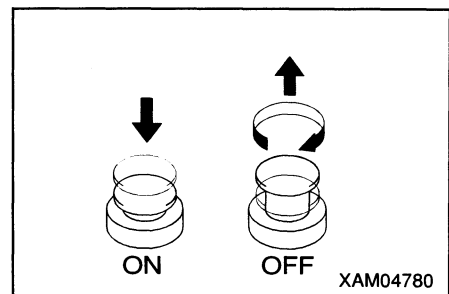

**1.3.3 Meters and lamps**

[1] **Load meter** ( See also Operation Manual for Moment Limiter )

**! WARNING**

- **Load meter indicates the mass (weight) of load being hoisted with winch. Hoisting any load in excess of rated load of the crane can cause tipping over or other damage. Crane work should always be carried out while making sure that the pointer of this meter remains within safety range.**
- **Failure of the load meter jeopardizes safe crane operation. Load meter should be always kept in normal conditions with monthly inspection carried out independently.**

It indicates the mass (weight) of the load being hoisted with winch. Scales of the load meter are provided for one, two and four part reeving according to number of wire rope part reeving of the hook. Read the scale that corresponds to your number of part reeving. Standard for this machine is 4 part reeving.

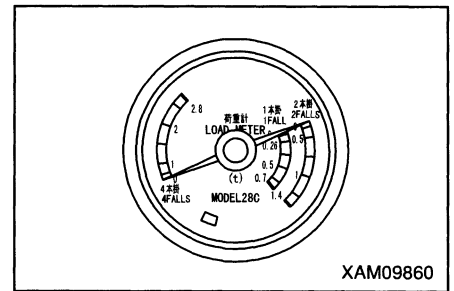

[2] **Leveling instrument**

**! WARNING**

**For setting up outrigger, adjust the level of machine while checking it by means of leveling instrument. Performing crane work with the machine inclined, may result in tipping over.**

It indicates inclination of the machine. Position of bubble tells the inclination of machine and its direction. Used for checking the levelness of machine when setting up outrigger. When the bubble comes to the center, the machine is level.

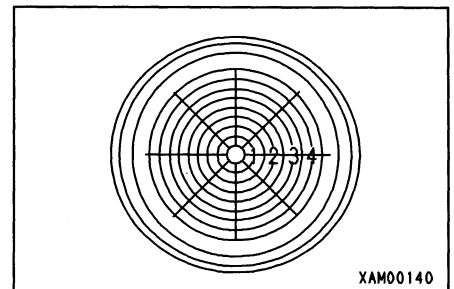

[3] **Outrigger mode indicator lamp**

It notifies that the outrigger is in operation. Operating the outrigger control switch to Extend or Retract, causes the lamp to flash and warning buzzer to sound intermittently. When the Outrigger mode has been selected by means of radio control, the lamp will flash and warning buzzer sounds intermittently even if the switch is not operated.

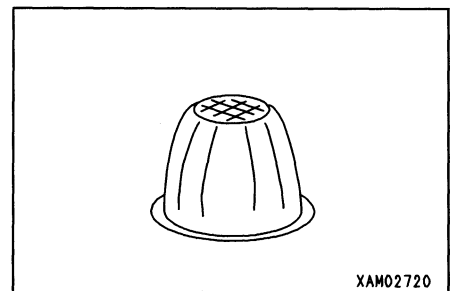

## 1.4 Over-hoist alarm system

**! WARNING**

Before conducting pre-work inspection or starting your crane work, be sure to turn the switch ② of the over-hoist alarm buzzer ① to ON position.

If the switch ② remains at OFF position, the alarm buzzer ① will not actuate, causing not merely the lifted load to hit various part of the crane causing damage, but the load to fall down and result in an accident.

**CAUTION**

Travelling the machine may cause the load to bounce and alarm to sound. When you let the machine assume travel position, turn OFF the switch ② for the over-hoist alarm buzzer ①.

The over-hoist alarm system ③ is designed to warn you by sounding the buzzer ① when the hook block ④ approaches the boom top end and pushes up the weight ⑤.

When the buzzer ① sounds, immediately place the winch lever, boom telescoping lever and boom hoist lever in Neutral to discontinue the motion, then place the winch lever in Lowering to cancel the over-hoist status.

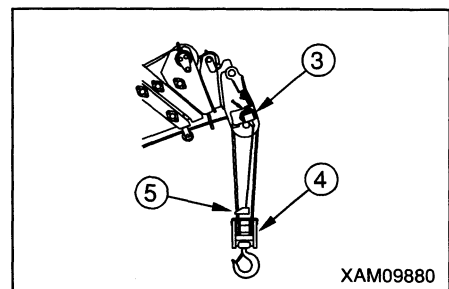
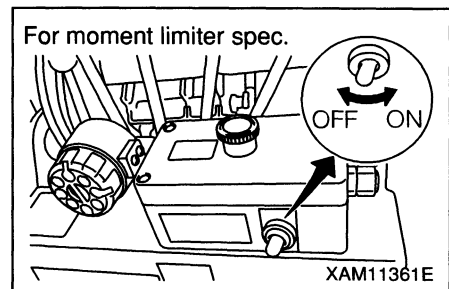
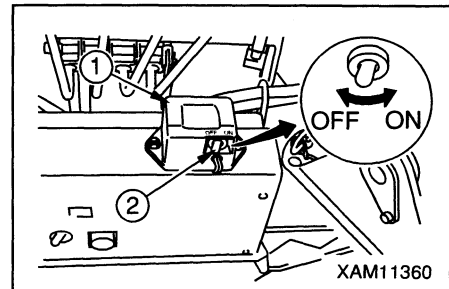



## 1.5 Machinery Cover

### **! WARNING**

- Before taking off the machinery cover, be sure to shutdown the engine and remove the key.
- Do not remove the machinery cover while engine is still hot such as immediately after completion of work.

#### [1] Removing the machinery cover

For maintenance the machinery cover internals, remove the machinery cover in the following manner:

1. Remove 8 mounting bolts ② of left hand side machinery cover ①.

#### NOTES

The mounting bolts ② are being used in quantity of 3 at the top, 3 at the rear and 2 on the side.

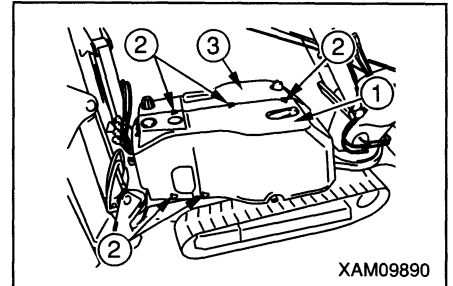

2. Remove 3 mounting bolts ④ of the right hand side machinery cover ③.

#### NOTES

The mounting bolts ④ are being used in quantity of 2 at the rear bottom and 2 at the side bottom.

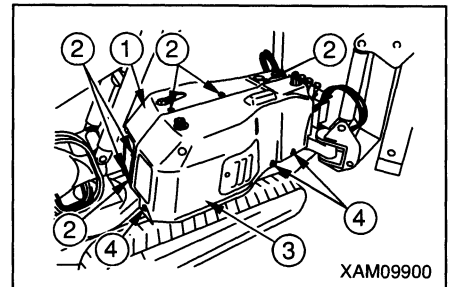

3. Remove the left side machinery cover ①.
4. Remove the right side machinery cover ③.

#### [2] Reinstallation of the machinery cover

Upon completion of servicing the machinery cover internals, replace the covers with the removing procedure reversed.

## 2. Operation and Controls

### 2.1 Before starting engine

#### 2.1.1 Walk-around checks

### ! WARNING

- This machine has a gasoline engine installed. If you smell diesel fuel around the engine, it is possible that it is leaking. Thoroughly check diesel fuel hose for any crack and its connections for tightness.
- Deposit of inflammable matter or oil leakage around high temperature zone including engine, muffler or battery may cause fire on the machine. Conduct visual inspection carefully and be sure to correct any abnormality or contact your dealer.

Before starting up the engine, check around the engine for smell of diesel fuel

Inspect externals and bottom of the machine to check for loosened bolt and oil leakage, in addition to checking the crane and hydraulic systems.

Check for looseness or play in electric wiring and deposit of trash in places where it is exposed to high temperature.

Inspections described in this section should be conducted before the first engine start-up of the day.

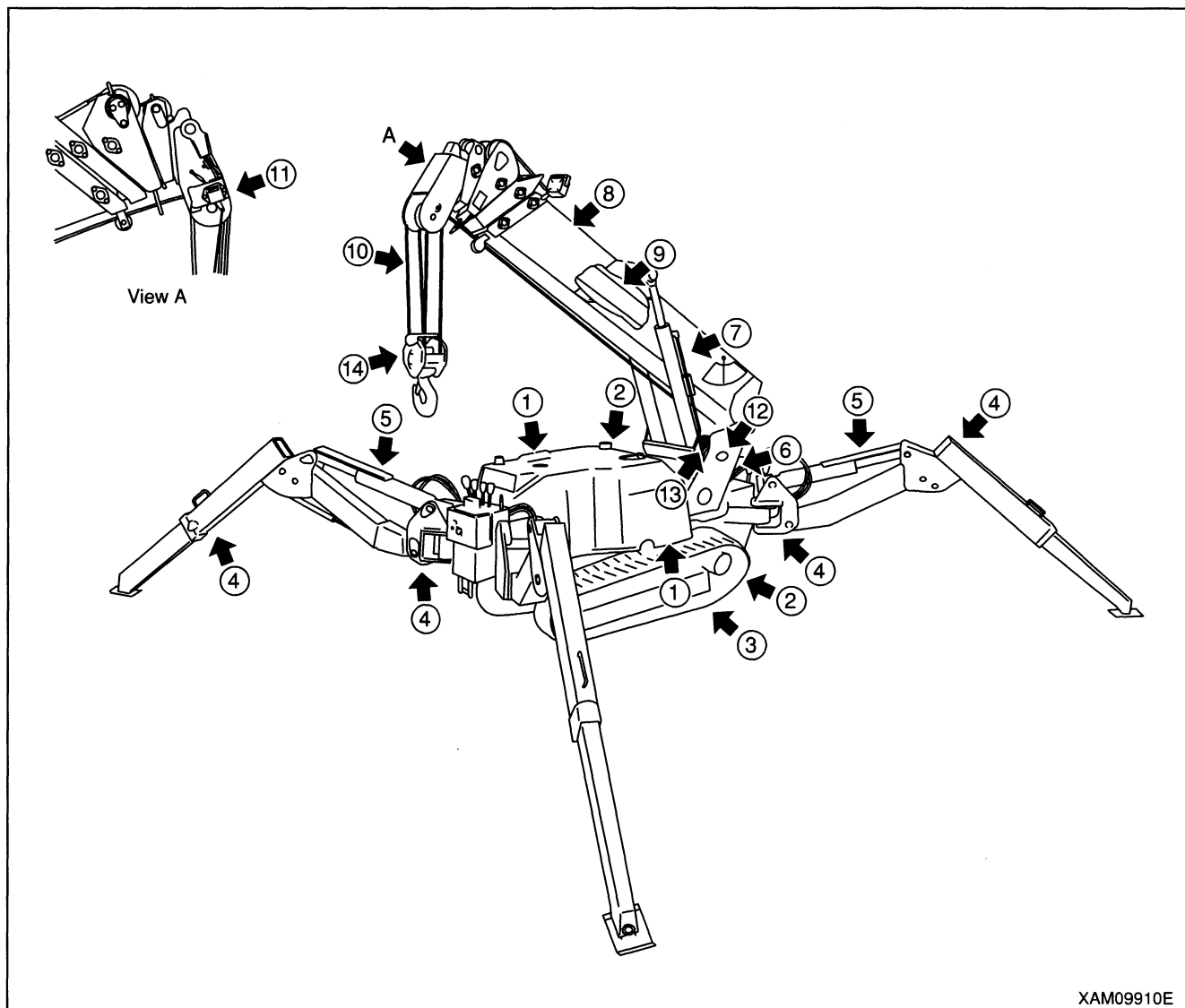

XAM09910E

**① Check around engine**

Check for and remove accumulation or deposit of inflammable items including fallen leaves, wastepaper, trash, oil or grease on high temperature area such as engine and muffler.

Check for fuel or oil leakage from engine and correct it as necessary.

Check for slackened wiring or loosened connection or trace of burning around starter, alternator or battery and correct any abnormality that may be found.

**② Check hydraulic system of undercarriage (travel motor, control valve, hydraulic oil tank, hose joint)**

Check for loosened pipe connection or oil leakage and correct any abnormality.

**③ Check undercarriage (rubber track, track roller, sprocket and idler)**

Check for damage, wear, loosened track roller and correct any abnormality. Check for loosened or missing bolt and retighten as necessary.

★ See "OPERATION, 3. Handling of rubber track" for detail.

**④ Check outrigger**

Check for crack, bend, damage, wear of support pin or the like and repair as necessary.

**⑤ Check outrigger cylinder**

Check for loosened pipe connection, oil leakage, wear or damage of support pin or the like and repair it as necessary.

**⑥ Check post**

Check for crack, bend, damage in various area, loosened post and slew ring mounting bolts, loosened slew system speed reducer mounting bolt, loosened pipe connections or oil leakage thereof and correct any abnormality detected.

**⑦ Check boom derrick cylinder**

Check for loosened pipe connection, oil leakage, wear or damage of support pin or the like and repair it as necessary.

**⑧ Check boom**

Check for crack, bend, damage in various area, wear of support pin or the like and repair it as necessary.

**⑨ Check boom telescope cylinder**

Check for loosened pipe connection or oil leakage and correct any abnormality that may be found.

**⑩ Check wire rope**

Check for damage, deformation, wear, twist, kink and corrosion and replace where necessary.

★ See "OPERATION, 4. Handling of wire rope" for detail.

**⑪ Check over-hoist preventive system**

Check the wire rope of over-hoist weight for damage or the like and replace it as necessary.

**⑫ Check winch motor**

Check for loosened pipe connection, oil leakage or loosened mounting or the like and repair it as necessary.

**⑬ Check winch drum**

Check the drum for crack, bend, damage or the like and repair it as necessary. Check hoisting wire rope for disorderly take-up and correct it as necessary

**⑭ Check hook block**

Check hook and sheaves for crack, bend, damage or the like and repair where necessary. Check hook and sheaves for proper rotation and correct it as necessary.

### 2.1.2 Checks before starting

Perform steps in this section before the first start of engine of the day.

#### [1] Check coolant level, and add water

#### **⚠ WARNING**

- **When checking coolant level and adding water, radiator cap must be always on. Be sure to perform checking at reservoir tank.**  
**High temperature coolant may gush out, causing you to get a burn.**
- **Cooling water should not be supplied from the upper part of the radiator. However if there is no other choice but to do it, check if the engine and surrounding parts are cool enough before doing it.**

1. Park the machine on level land.
2. Check the coolant level of reservoir tank ① is at midpoint between LOW and FULL through the inspection window ④ at the front right side of machinery cover.
3. When it is below LOW, add city water following the procedures below.
  - (1) Referring to "OPERATION, 1.5 Machinery cover", remove the machinery cover.
  - (2) Remove the cap of reservoir tank ① and add water up to the FULL level through the water filler.
  - (3) After the replenishment of coolant, securely mount the cap ② of reservoir tank ①.
  - (4) Referring to "OPERATION, 1.5 Machinery cover", mount the machinery cover.
4. When the reservoir tank is empty, take the following procedures.
  - (1) Referring to "OPERATION, 1.5 Machinery cover", remove the machinery cover.
  - (2) Remove the radiator cap ③ and check the radiator for coolant level.
  - (3) When it is too low, check the radiator, radiator hose, and each part of engine for water leakage.
  - (4) Add water through the water filler of radiator and securely tighten the radiator cap ③.
  - (5) Remove the cap ② of reservoir tank ① and add water up to the FULL level through the water filler.
  - (6) After the replenishment of coolant, securely mount the cap ② of reservoir tank ①.
  - (7) Referring to "OPERATION, 1.5 Machinery cover", mount the machinery cover.

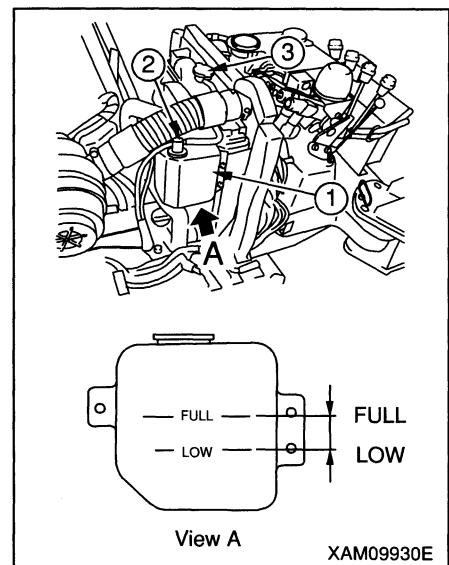
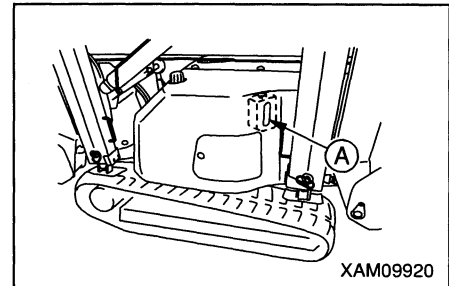

**[2] Check radiator fin, and clean it****! WARNING**

**Use of compressed air causes trash and dusts to scatter, putting you in hazardous situation. To protect you from such situation, be sure to wear safety glasses and protection mask.**

**CAUTION**

- When using compressed air, reduce its pressure down to 0.20 to 0.29MPa (2 to 3kg/cm<sup>2</sup>), and blow it at a certain distance away from the fin to prevent it from being damaged.  
Damage on the fin may cause water leakage and overheat.
- In a dusty place, inspect the fin everyday and clean it, if necessary.

1. Remove the machinery cover. See “OPERATION, 1.5 Machinery cover”.
2. Blow compressed air (0.20 to 0.29MPa [2 to 3kg/cm<sup>2</sup>]) to the oil cooler ② and radiator ① to remove mud and trash which are clogging the fin.
3. Install the machinery cover. See “OPERATION, 1.5 Machinery cover”.

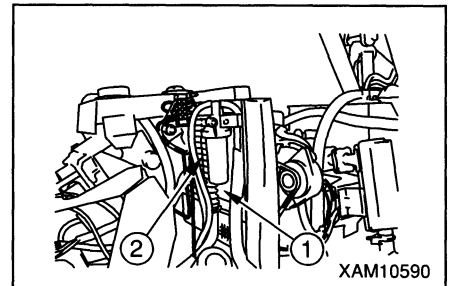

[3] Check oil level in engine, and add oil

**CAUTION**

After oil level check and replenishment, install oil level gauge properly to prevent the gauge from falling off during operation, which may cause scalding due to shooting hot oil.

**CAUTION**

- As for the oil to be used, see Part IV Inspection and Service, 5.1 Application of lubricant in accordance with ambient temperature. Use of oil which is not recommended, may shorten the service life of your engine. Be sure to replenish with recommended oil.
- Level of engine oil should be maintained properly. Excessive feed of oil may lead to its increased consumption or its pre-matured deterioration as its temperature is prone to rise. Insufficient oil on the other hand may cause seizure in engine.

1. Park the machine on level ground.
2. Open the inspection cover ① on the side surface of right machinery cover.  
To unlock the inspection cover ①, insert the key ② into the key hole and counterclockwise turn it, and then pull the cover toward you.
3. Pull out oil level gauge ③ and wipe off any oil with waste cloth.
4. Insert the gauge into filler port and pull out it again.
5. Oil level is proper if it is between the markings H and L on the gauge rod ④.
6. If oil does not reach the "L" mark, remove filler port cap ⑤ and replenish with oil through filler port.

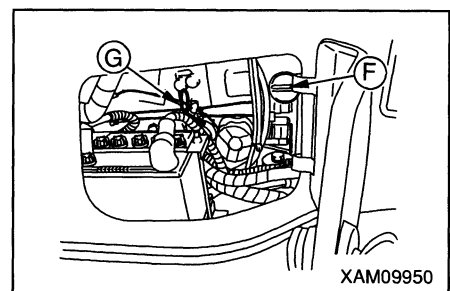
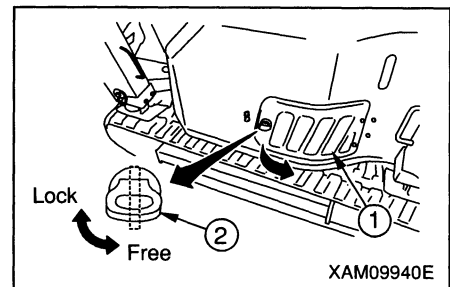

**NOTES**

Oil should be replenished to midway between the markings H and L on level gauge rod ④.

7. After replenishment, re-install gauge rod ④ and filler port cap ⑤ securely.
8. Close the inspection cover ① and clockwise turn the key ②. Pull the inspection cover ① lightly to check that it is locked, and pull out the key ②.

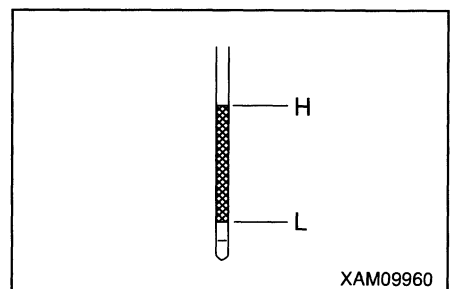

## [4] Check fuel level in fuel tank, and add fuel

**! DANGER**

- As for the fuel to be used, see Part IV Inspection and Service, 5.1 Application of lubricant in accordance with ambient temperature.
- Be careful about fire including that of lit cigarette.
- For replenishment of fuel, be sure to shutdown the engine. Feeding fuel with engine running, may cause inflammation due to spilled fuel on heated muffler.
- Excessive feed of fuel is dangerous as it may cause spilling. Stay on the slightly lower side of specified maximum level. Any spilled fuel should be wiped off thoroughly.
- After replenishment, close the tank cap securely.

1. Turn the engine key to ON position and check the fuel gauge on monitor panel to see that the tank is full (Close to F mark).
2. If insufficient, take the cap (F) off the tank top and replenish with fuel through filler port while watching the fuel gauge.
3. After replenishment, turn the tank cap (F) to close it securely.

**NOTES**

After a day's work, be sure to fill the tank with fuel.

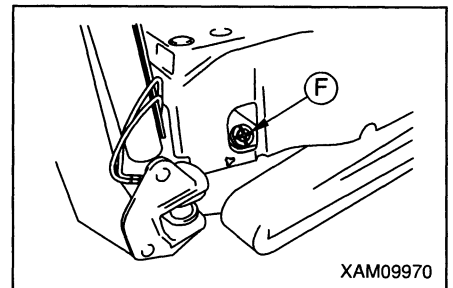
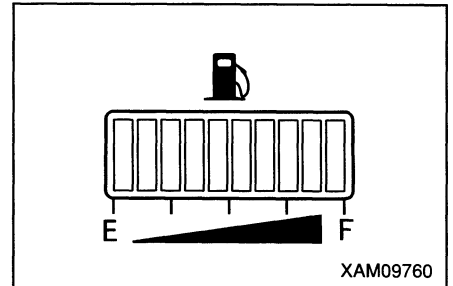

## [5] Check water separator, and clean it

**! WARNING**

- **Water separator pot contains fuel (diesel fuel).**  
**When you clean it, be careful about fire including cigarette.**
- **If fuel is spilled when you remove the water separator part, be sure to wipe it off.**

**CAUTION**

- **Water or trash which remains in the water separator may constitute a cause for engine trouble. Check the pot internals and remove them as necessary.**
- **When water remains in the water separator pot, a lot of mixed water in fuel tank is suspected. Referring to “MAINTENANCE, 8.7 Service in every 50 hours”, remove mixed water and trash from the fuel tank.**

1. Remove the machinery cover. See “OPERATION, 1.5 Machinery cover”.

2. Check inside of the ① water separator pot in the front side of the radiator to confirm that there is no dust accumulation, and that the ② red float keeps in touch with the bottom.  
If the ② red float is above the bottom, water is present.

3. If there is any water or trash remaining inside the water separator pot ①, clean its internals in the following manner:

(1) Turn fuel lever ③ to horizontal position (Close) to stop flow of fuel.

(2) Loosen retainer ring ④ by rotating it counterclockwise and remove water separator pot ①.

(3) Pull out the element ⑤ from the pot ①.

(4) Cleanse the water separator pot ① with light oil, before blowing its internals with compressed air (0.20 – 0.29Mpa or 2 – 3kgf/cm<sup>2</sup>) to remove surface dust.

(5) Insert the element ⑤ to the pot ①.

(6) Mount back the pot ① and tighten the retainer ring ④ by clockwise turning it.

(7) Turn the fuel lever ③ to vertical position (Open)

4. Install the machinery cover. See “OPERATION, 1.5 Machinery cover”.

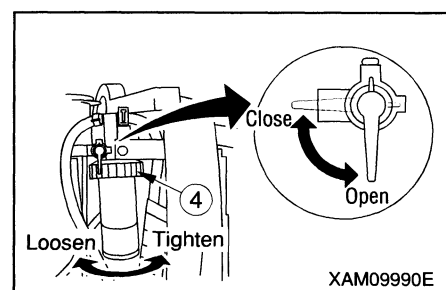
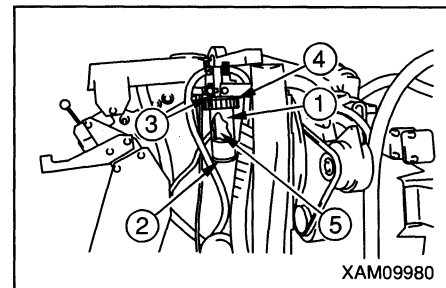



**[6] Check fuel filter****! WARNING**

- Fuel filter contains fuel ( diesel fuel ). When replace it, be careful about fire including lit cigarette.
- If fuel is spilled, be sure to wipe it off.

**CAUTION**

**Water or trash remaining in the fuel filter constitutes a cause for engine trouble. Check the fuel filter internals and remove them.**

1. Remove the machinery cover. See “OPERATION, 1.5 Machinery cover”.
2. Check the fuel filter to make sure trash does not remain in the filter case.
3. If trash remains within the fuel filter, replace the fuel filter in the following manner.
  - (1) Remove the fuel filter ② from the holder ①.
  - (2) Loosen the clamps ⑤ of fuel hoses ③ and ④ connecting to the fuel filter ②, and disconnect the fuel hoses ③ and ④.
  - (3) Connect the fuel hoses ③ and ④ to new fuel filter ② to assuredly prevent them from falling with the clamps ⑤.
  - (4) Insert the fuel filter ② into the holder ① to assuredly secure it.

**NOTES**

After inserting the fuel filter into the holder, lightly shake the fuel filter to check that it is firmly secured.

- (5) After replacing the fuel filter, bleed the fuel system.

4. Install the machinery cover. See “OPERATION, 1.5 Machinery cover”.

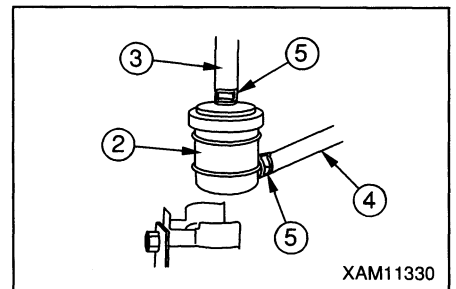
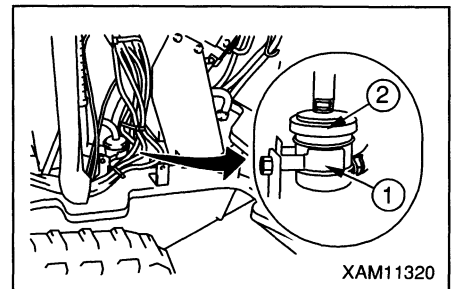

## [7] Check oil level in hydraulic tank, and add oil

**! WARNING**

- When you remove hydraulic tank filler port cap, oil may gush out.  
Loosen mounting bolts of cap, slightly raise it to relieve internal pressure, remove mounting bolts, and remove cap.
- After replenishment of oil, securely tighten mounting bolts of filler port cap.  
Otherwise, mounting bolts may be loosened during operation, causing cap to fall and hot oil to gush out to produce burn.

**CAUTION**

- For the type of oil to use, see “MAINTENANCE, 5.1 Use of oil according to ambient temperature”.
- Before checking the oil level, let the machine assume travel position. Checking the oil level with the machine remaining in working position tends to cause over-filling, because oil in each cylinder may not have returned to the tank.
- Do not feed oil to exceed the level point on the gauge (red dot). Excessive filling may cause oil to gush out through air breather while traveling or during crane work.

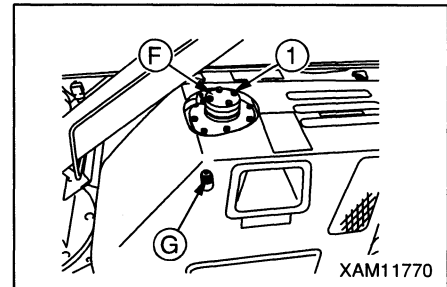

1. Check the oil level gauge (G) of the inspection hole on the left side of machinery cover to see that oil is up to the level point (red dot).
2. If oil is insufficient, remove the four mounting bolts (1) on the top surface of hydraulic tank to remove the cap of filler port (F).
3. Replenish with hydraulic oil through filler port (F) while watching the level point (red dot).
4. After the replenishment of oil, place back the cap of filler port (F) and securely tighten the four mounting bolts (1).

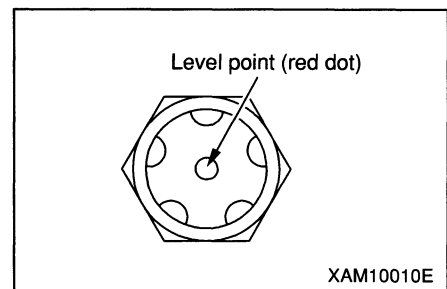

[8] Check oil level in swing machinery case, and add oil.

### **! WARNING**

After replenishment of oil, securely tighten filler port plug. Otherwise, filler port plug may fall during operation, causing hot oil to gush out to produce burn.

### **CAUTION**

- For the oil to be used, see “MAINTENANCE, 5.1 Application of lubricant in accordance with ambient temperature”.
- After the check and replenishment of oil, take measures against oil leakage by winding seal tape around threaded portion of level check plug and filler port plug, before tightening them securely.

1. Park the machine on the level ground.
2. Remove the machinery cover. See “OPERATION, 1.5 Machinery cover”.
3. Remove the filler port plug (F) from the swing reducer case, put your finger into the plug hole to check if oil fills the case up to the plug hole level.
4. If insufficient, feed gear oil through the plug hole of filler port plug (F).

### **NOTES**

Feed gear oil almost up to the filler port plug hole level.

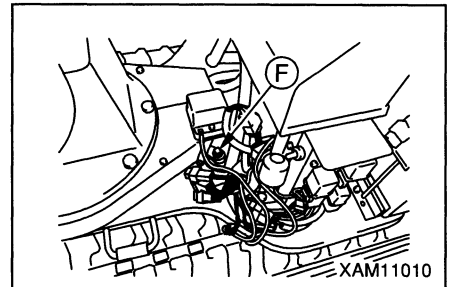

XAM11010

5. After the inspection and replenishment of oil, securely tighten the filler port plug (F).
6. Install the machinery cover. See “OPERATION, 1.5 Machinery cover”.

## [9] Check and adjust rubber crawler tension

**CAUTION**

- For performing rubber crawler check and adjustment, set up outrigger and lift the machine so that its crawler are about 80mm off the ground.
- Tension of rubber crawler is normal, if the clearance between bottom of track roller and shoulder of crawler is 5 to 10mm at midway.
- In case crawler is loose even after packing the grease, it will be necessary to replace the rubber crawler or the seal of tension adjust cylinder. For the judgment of whether to replace, repair or continue to use the existing crawler, contact your dealer.

Because the progress of rubber crawler wear will vary depending on working conditions or ground, always watch the wear and tension. Particularly in case new machine or new crawler has been installed, after adjusting the tension to specified value, keeping to travel for 5 to 30 hours will cause initial slack to develop. Until such initial slackening period elapses, tension adjustment has to be carried out diligently. It helps avoid rubber crawler coming off due to lack of tension.

**[Checking the tension]**

1. Set up outrigger and lift the track by about 80mm off the ground.
  - ★ For outrigger setting up procedure, see "OPERATION, 2.12 Setting up the outrigger", for detail.
2. Move the machine so that joint (M mark) of rubber crawler comes over the center between the shafts.
3. Measure the clearance between bottom of the track roller in the middle and shoulder of the rubber crawler.

**NOTES**

If the clearance is 5 to 10mm, the tension falls within the standard.

4. If the tension is out of such standard, make adjustment in accordance with Tension Adjustment in the next page.

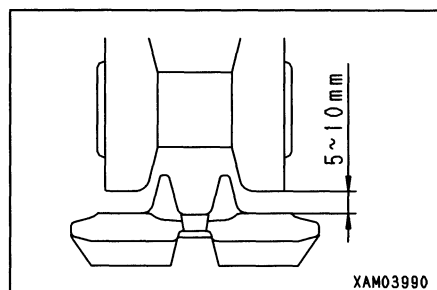
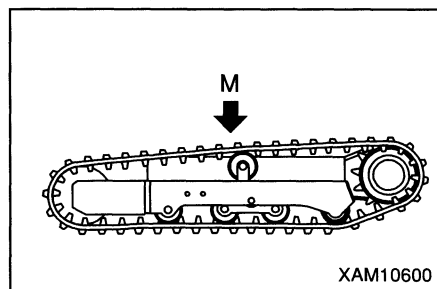

**[Tension Adjustment]**

If, as the result of rubber track tension check, the tension is weaker than standard, make adjustment in the following procedure:

Working with the track slackened (bend of rubber track being 15mm or greater), will cause the track to go off the rollers or pre-matured wear of core metal to develop.

- In case tension is weak (to increase tension)
- ★ Have a grease gun (pump) ready.
- 1. With 2 mounting bolts ② removed, take off the inspection cover ①.
- 2. Pack the grease through grease valve ③ by means of grease gun.
- 3. To confirm that the tension is proper, proceed with following:
  - (1) With the outrigger stowed away, ground the machine.
    - ★ For the outrigger stowing method, see “OPERATION, 2.23 Stowing the outrigger”.
  - (2) Let the machine travel back and forth.
  - (3) Set up the outrigger and lift the machine again by about 80mm off the ground.
    - ★ For the outrigger setting up method, see “OPERATION, 2.12 Setting up the outrigger”.
- 4. Again, conduct the rubber track tension check. If it is not proper yet, repeat the procedure again.
- 5. Using the 2 mounting bolts ②, reinstall the inspection cover ①.
- 6. Stow away the outrigger and lower the machine to ground.
  - ★ For the outrigger stowing method, see “OPERATION, 2.23 Stowing the outrigger”.

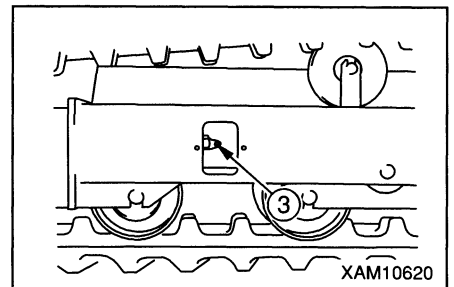
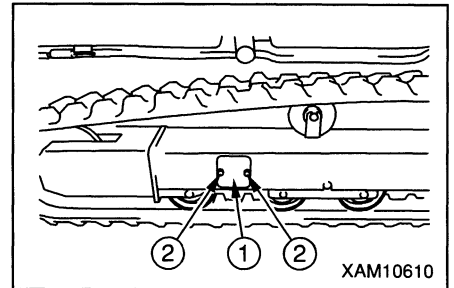

- In case the tension is strong (to reduce tension)

### **! WARNING**

**Grease is packed inside the rubber crawler tension adjust system, and the grease is at high pressure due to tension of the track. By making adjustment without observing following instruction, grease valve may spring out, to cause serious accident.**

- **Tension adjustment grease valve should not turned out by more than one turn. It may cause grease valve to spring out.**
- **To make tension adjustment, do not position yourself in front of the grease valve to avoid possible risk.**

1. With 2 mounting bolts ② removed, remove the inspection cover ①.
2. Loosen grease valve ③ bit by bit to let the grease come out.
3. Use care not to loosen the grease valve ③ by more than one turn.
4. If the grease does not come out smoothly, take following measures:
  - (1) Stow away the outrigger and lower the machine to ground.
    - ★ For the outrigger stowing method, see “OPERATION, 2.23 Stowing the outrigger”.
  - (2) Move the machine back and force.
  - (3) Set up outrigger and lift the undercarriage off the ground by about 80mm.
    - ★ For the outrigger setting up method, see “OPERATION, 2.12 Setting up the outrigger”.
5. Turn-in the grease valve ③.
6. Conduct the rubber crawler tension check. If the tension is still improper, repeat the adjustment again.
7. Using the 2 mounting bolts ②, reinstall the inspection cover ①.
8. Stow away the outrigger and lower the machine to ground.
  - ★ For the outrigger stowing method, see “OPERATION, 2.23 Stowing the outrigger”.

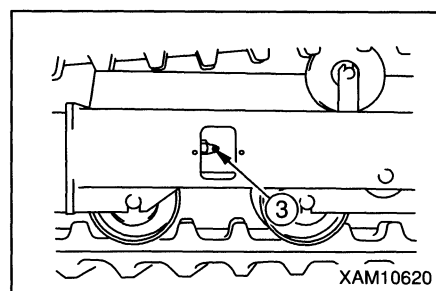
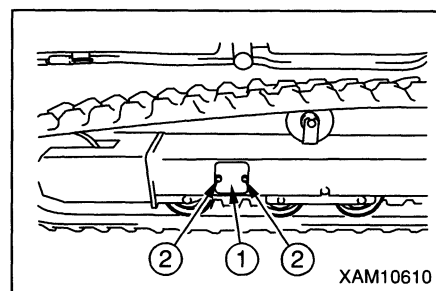

**[10] Check damage and wear for rubber crawler**

**CAUTION**

**For making judgment whether to replace, repair or continue to use the existing rubber crawler, contact your dealer.**

Your track needs to be repaired or replaced when it falls in the following condition. Contact you dealer for action.

**[Lug height]**

- When the lug height “a” is reduced by wear, traction force drops. If the lug height “a” is reduced to less than 5mm, replace it with new track.
- With lug having worn, if steel cord inside the rubber track is exposed over two or more links, the track should be replaced.

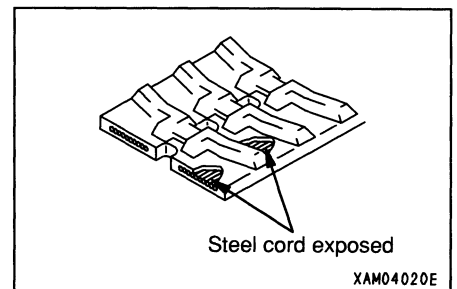
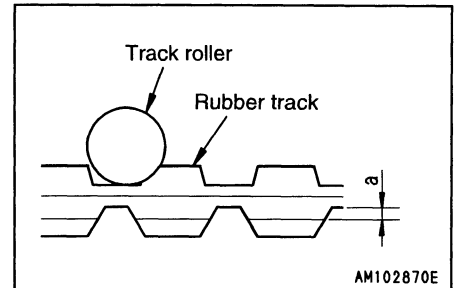

**[Breakage of steel cord]**

- Any rubber track with more than one half of its steel cord layer on one side is broken, should be replaced with new one.

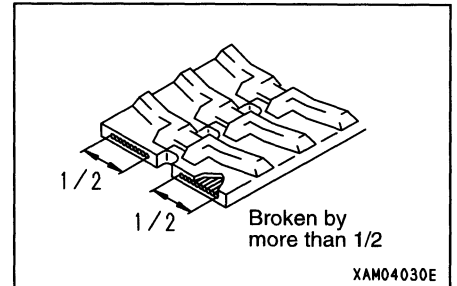

**[Dropping out of core metal]**

- Any rubber track with its core metal having dropped out at one or more locations should be replaced with new one.

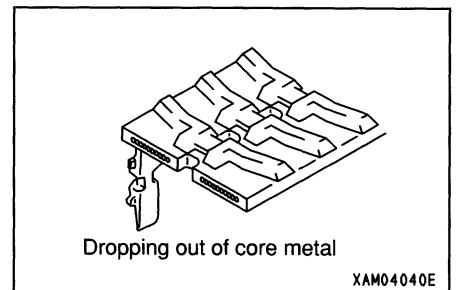

**[Crack]**

- Any crack which develops between rubber track lugs should be repaired when it has grown to about 30mm in length. However, even if the crack appears to be small and short, in case it exposes internal steel cord, it should be repaired immediately.

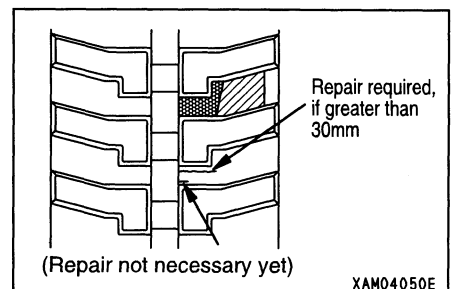

## [11] Check electrolyte level

**! WARNING**

- Battery generates inflammable gas which may explode. Do not allow any fire to approach.
- Electrolyte is dangerous. Do not allow it to get in your eyes or on skin. If it has got on, wash it off with plenty of water and see doctor for treatment.
- Do not replenish with electrolyte in excess of its maximum level line indicated. It may cause fire when it leaks.

**CAUTION**

- Keep the top surface of battery clean by wiping with wet cloth.
- When required to replenish with distilled water, in order to avoid freezing, do it before starting your work the following morning.

1. Park the machine on the level ground.
2. Remove the machinery cover. See "OPERATION, 1.5 Machinery cover".
3. Check the electrolyte level by looking through the side of battery case.

**NOTES**

Clean the battery case if it has been smeared.

4. Check that the electrolyte is up to the maximum level line ①.
5. If not, remove all the battery caps ③ (x6) and replenish up to the maximum level ①.

**NOTES**

If electrolyte is spilled, refill with dilute sulfuric acid.

6. Check breather hole of battery cap ③, clean any clogged cap before tightening securely.
7. Install the machinery cover. See "OPERATION, 1.5 Machinery cover".

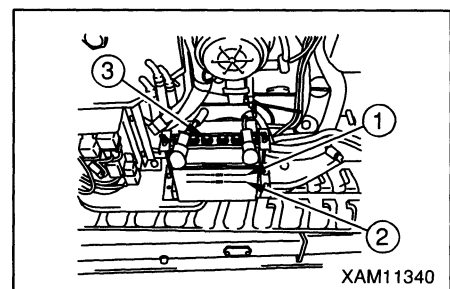



**[12] Check over-hoist alarm system**

1. Insert key to starter switch and turn it to ON position to conduct following check:

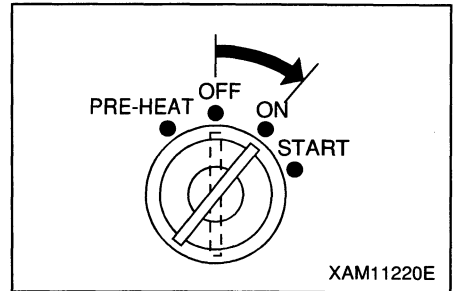

2. Place the switch ② of over-hoist alarm system at ON position to check if the alarm buzzer ① sounds.

If not, the failure of alarm buzzer of over-hoist alarm system is suspected.

Contact your dealer to receive service.

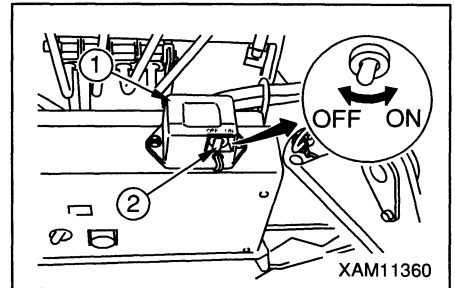

3. Press down the lever ④ of over-hoist alarm system ③ to check that the alarm buzzer stops.

If not, the failure of over-hoist alarm system is suspected.

Contact your dealer to receive service.

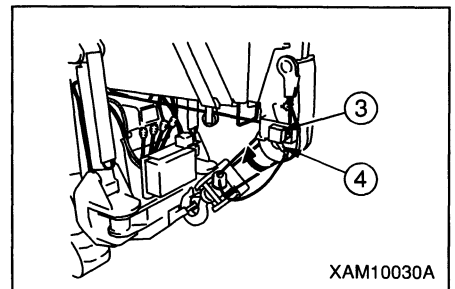

**[13] Check horn**

1. Insert key to starter switch and turn it to ON position to conduct following check:

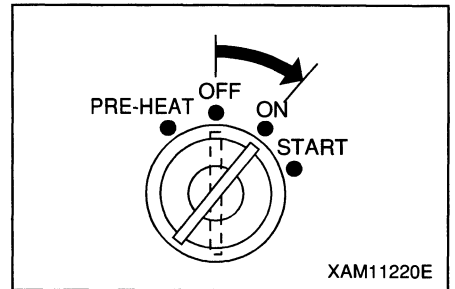

2. Press the horn switch and make sure that horn sounds. If not, trouble in the horn or a wiring failure is conceivable. Contact your dealer for repair.

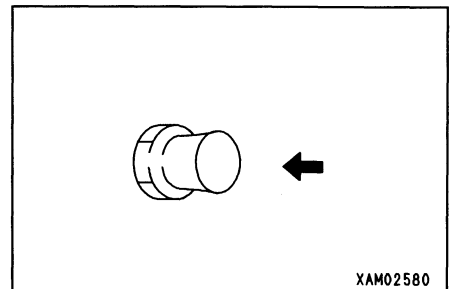

**[14] Check working light**

1. Insert key to starter switch and turn it to ON position to conduct following check:

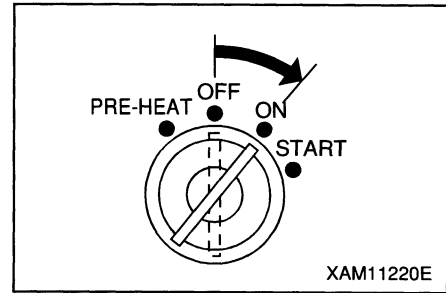

2. Pull the working light switch to see if the working light at top of the left and right No.1 boom goes on. If it does not, blown bulb or wiring failure is conceivable. Contact your dealer for repair.

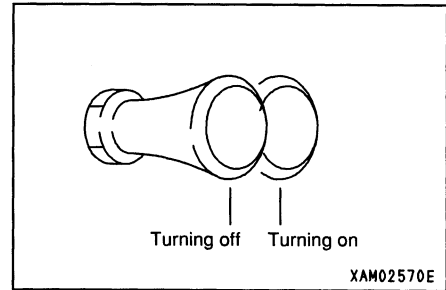

**[15] Check electric wiring**

**! WARNING**

- If fuse blows frequently or there is a trace of electric wiring having short circuited, be sure to check for the cause and correct.
- Accumulation of inflammable stuff such and dead leaves, dead twig or dry grass can be a cause for fire. Be sure to remove them.
- Keep the top surface of battery clean and check breather hole in the battery cap. If it is clogged with dirt, wash it with water to eliminate clogging.

Remove the fuse holder at the travel controller to check if the tube fuse is damaged or blown.

Check the electric wiring for trace of disconnection or shortcircuit. Check the terminals for looseness and if any, tighten them. Particularly, check the wiring of battery, starter, and alternator carefully.

In addition, check if combustible materials are deposited around the battery and if any, be sure to remove them.

If the fuse is blown or a trace of disconnection or shortcircuit of electric wiring is found, contact your dealer to receive service.

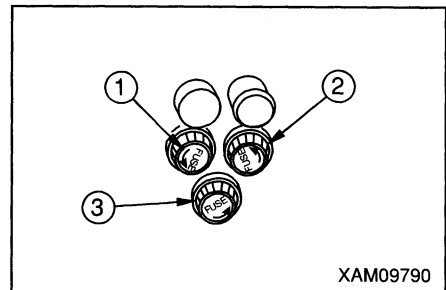

**[16] Check crack, deformation or damage of boom and frame**

Check the boom and frame for crack, deformation or any other damage, and correct them if anything abnormal is found.

**[17] Check deformation, damage or wear of wire rope**

Check the rope end fixing, rope take up condition and contact between the ropes. For the check and inspection of wire rope while winch and boom telescoping, See “OPERATION, 4. Handling of wire rope” for detail.

**[18] Check and adjust boom telescope wire rope**

**⚠ CAUTION**

**For performing the check and adjustment of wire rope, be sure to wear heavy working gloves.**

**[Check wire rope]**

Adjustment is required in case the wire rope for pulling out boom falls on such condition as shown below:

1. Position the boom horizontally and while retracting the boom, check to see that the boom pull-out wire rope is slacked at its midway. If it is slacked down, see Wire Rope Adjustment and make the adjustment.

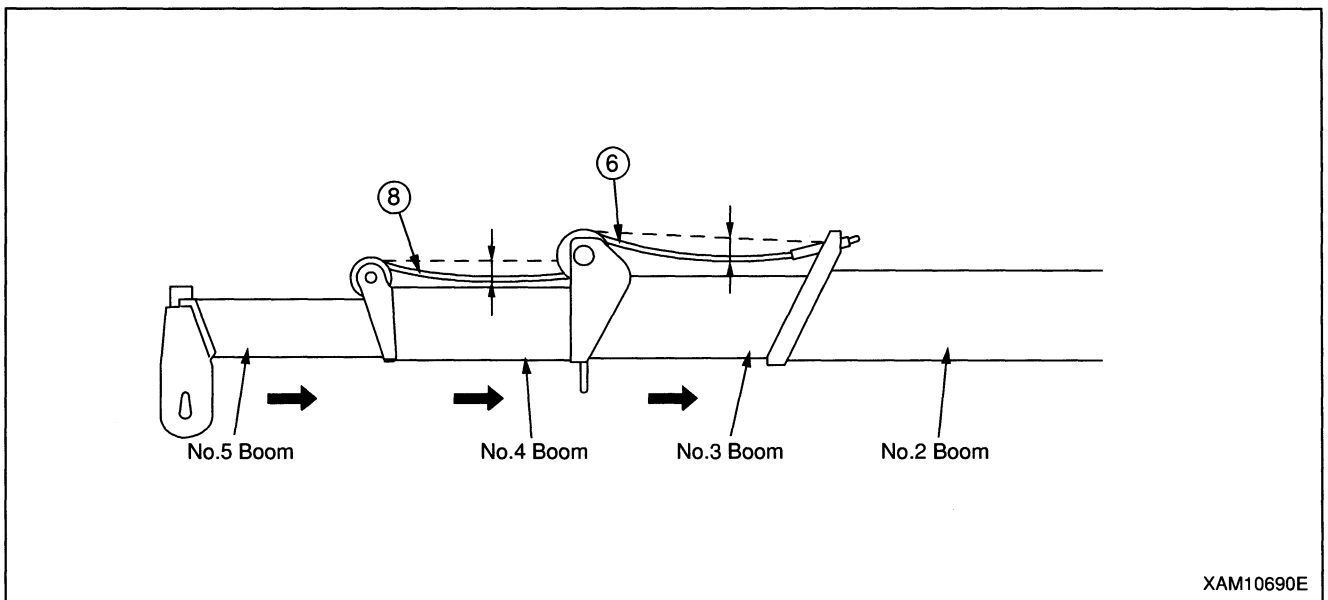

2. With the boom positioned horizontally and all the booms retracted, check to see if a clearance of 6mm or greater remains between the booms No.3 and No.4 (clearance (a)) and between No.4 and No.5 (clearance (b)). (See drawing to the right)

If the clearance of 5mm or greater remains, make the adjustment in reference to “Adjust wire rope”.

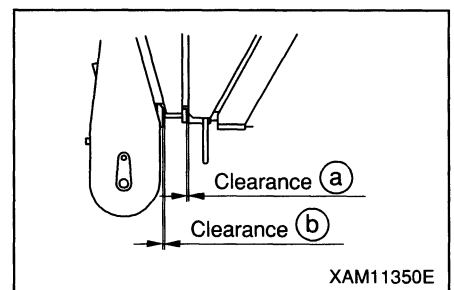

[Adjust wire rope]

**! WARNING**

**When making adjustment of each wire rope, be careful not to give any excessive tension.**

Four boom pull-out and pull-in wire ropes are in use. There is a sequence such as follows for making adjustment of these wire ropes, which should always be observed:

1. With the boom totally retracted and positioned horizontally, extend boom which makes simultaneous telescoping movement by approx. 2m.

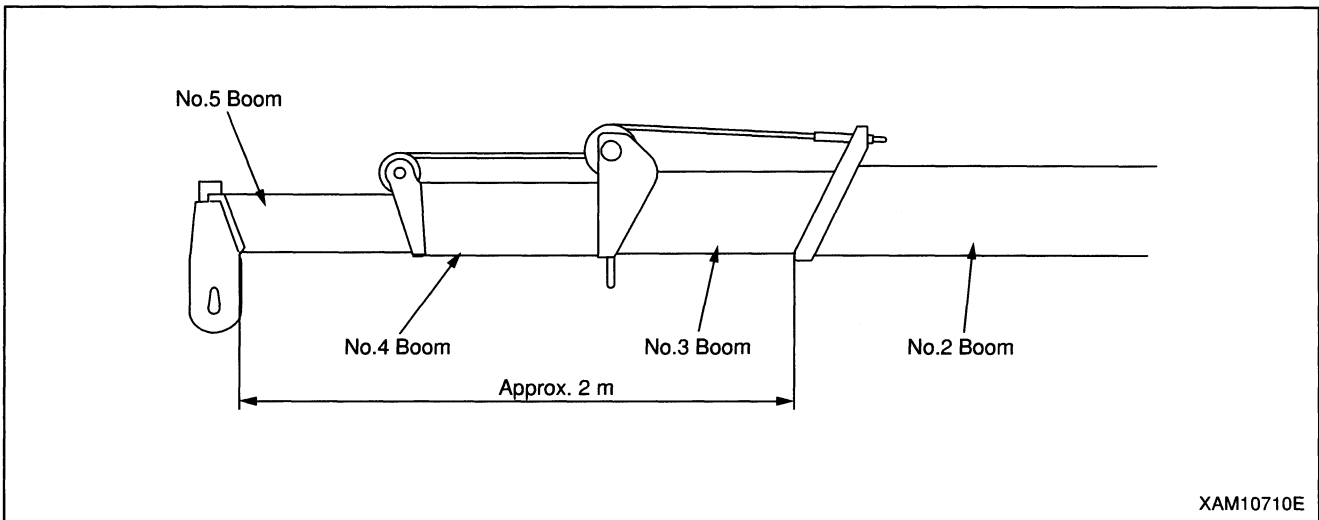

2. Retract boom slowly to stowed position. In this position, measure the clearance (a) and (b), and make following judgment:

- If the clearance (a) is 5mm or greater, adjust the No.4 boom pull-in wire rope (5).
- If the clearance (a) is zero, make the adjustment in accordance with “Adjust No.4 boom pull-out wire rope (6)” in step 4 below:

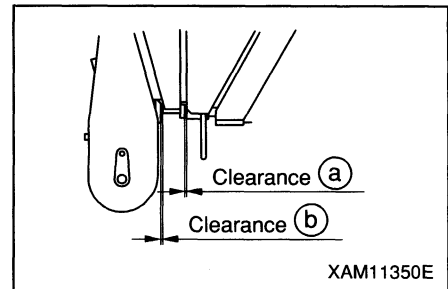

3. Adjust No.4 boom pull-in wire rope (5)

- (1) Loosen the lock nut (9), then tighten the right and left side adjustment nut (10) evenly in the direction of tightening the No.4 boom pull-in wire rope (5) until the clearance (a) becomes zero.
- (2) After completion of steps 1 and 2, and as the result of measurement thereof, if the clearance (a) of 5mm or greater remains, repeat the adjustment procedure.

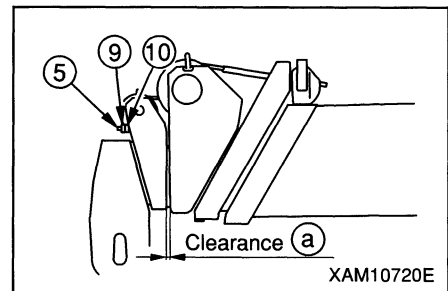

## 4. Adjust No.4 boom pull-out wire rope ⑥

- (1) Loosen the lock nut ⑪, then tighten the right and left side adjustment nut ⑫ evenly in the direction wherein the No.4 boom pull-out wire rope ⑥ is tightened, to the point immediately before the No.4 boom starts to be extended.
- (2) Retighten both right and left adjustment nuts ⑩ for the No.4 boom pull-in wire rope ⑤ further by one more turn.

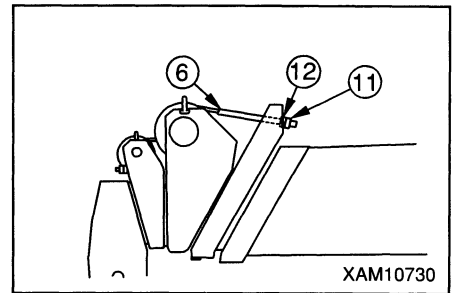

- (3) Lock the adjustment nuts ⑩, ⑫ for No.4 boom pull-in and pull-out wire ropes ⑤, ⑥ with respective lock nuts ⑨, ⑪.
- (4) After completion of steps 1 and 2, and as the result of measurement thereof, if the clearance ⑬ of 5mm or greater remains, make the adjustment in accordance with the step 5 "Adjust No.5 boom pull-in wire rope ⑦". if the clearance ⑬ is zero, make the adjustment in accordance with the step 6 "Adjust No.5 boom pull-out wire rope ⑧".

## 5. Adjust No.5 boom pull-in wire rope ⑦

- (1) Loosen the lock nut ⑬, then tighten the right and left side adjustment nut ⑭ evenly in the direction of tightening the No.4 boom pull-in wire rope ⑦ until the clearance ⑬ becomes zero.
- (2) After completion of steps 1 and 2, and as the result of measurement thereof, if the clearance ⑬ of 5mm or greater remains, repeat the adjustment procedure.

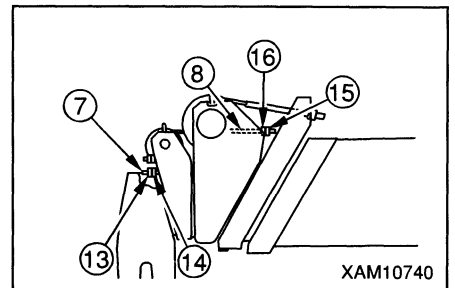

## 6. Adjust No.5 boom pull-out wire rope ⑧

- (1) Loosen the lock nut ⑮, then tighten the right and left side adjustment nut ⑯ evenly in the direction wherein the No.5 boom pull-out wire rope ⑧ is tightened, to the point immediately before the No.5 boom starts to be extended.
- (2) Retighten both right and left adjustment nuts ⑭ for the No.5 boom pull-in wire rope ⑦ further by one more turn.
- (3) Lock the adjustment nuts ⑭, ⑯ for No.5 boom pull-in and pull-out wire ropes ⑦, ⑧ with respective lock nuts ⑬, ⑮.

## [19] Inspection of operation of winch and boom

**! WARNING**

For checking operation of winch and boom, be sure to see "OPERATION, 2.2 Starting the engine" and "OPERATION, 2.3 Operation and checks after the engine starts".

1. Check if each of lifting, lowering, boom hoisting, telescopic, and swing operations is correctly performed in accordance with operation of the control lever.
2. During the step 1 above, check if no abnormal sound is heard from any part of crane such as the boom and hydraulic motor.
3. Operate the crane under no load and check the bolts and nuts of each part for falling and looseness.
4. Check if the hook is deformed, abnormal sound is heard from the bearing, and the latch ① of wire rope is correctly functioning.

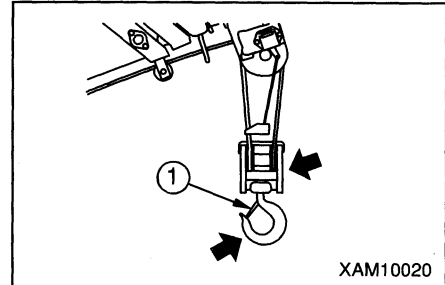

## 2.2 Starting the engine

### **⚠ WARNING**

Before starting your engine, make sure that there is no person or obstacle around and sound horn.

### 2.2.1 Starting the engine with main starter switch

#### **CAUTION**

- Do not keep the starter turning for more than 5 seconds. It accelerates discharge of battery. If the engine fails to start, wait for about 2 minutes before attempting again.
- Before starting the engine, make sure that fuel level of water separator pot is in vertical (Open) position.
- Make sure that main switch on radio control box is in OFF position.

1. Pull up the accelerator lever and place it at medium engine speed range (about midway).
2. Insert the key into main starter switch and turn it to Start position.
3. When the engine starts, release the key, It will return to ON position automatically.

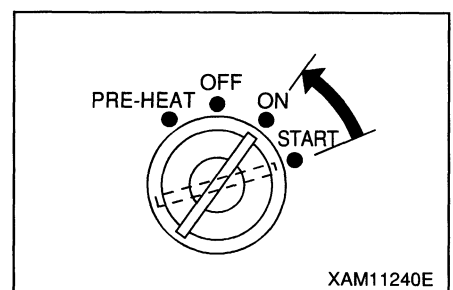
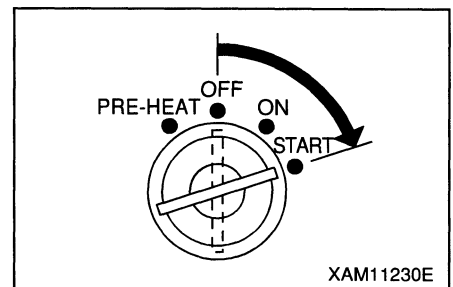
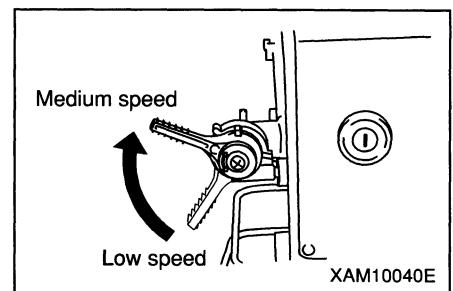

2.2.2 Start the engine with main starter switch in cold weather

**CAUTION**

- Do not keep the starter turning for more than 5 seconds. It accelerates discharge of battery. If the engine fails to start, wait for about 2 minutes before attempting again.
- Before starting the engine, make sure that fuel level of water separator pot is in vertical (Open) position.
- Make sure that main switch on radio control box is in OFF position.

When starting the engine in cold temperatures, do as following procedure.

1. Pull up the accelerator lever and place it at medium engine speed range (about midway).

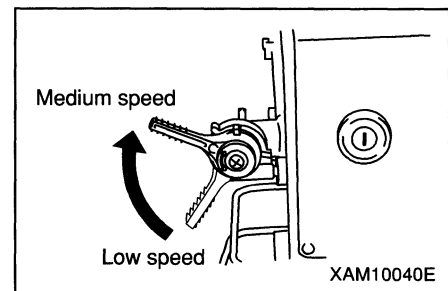

2. Insert the key into the main starter switch, turn it to Preheat position, and hold the key there for three seconds. The key automatically returns to ON position when you release it.

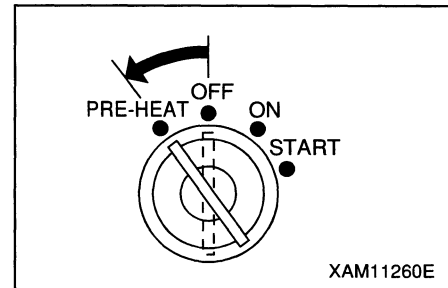

3. After three seconds, turn the key to START position.

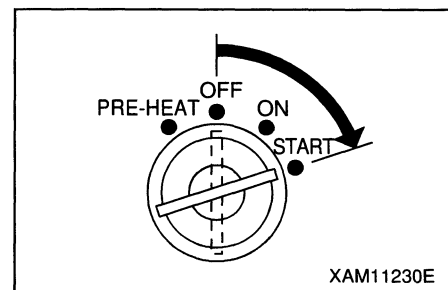

4. When the engine starts, release the key, It will return to ON position automatically.

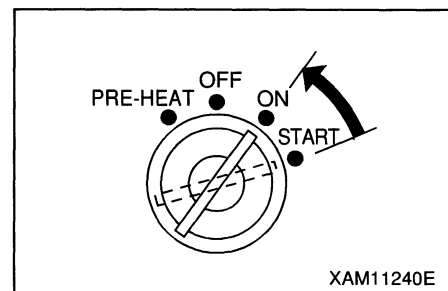



**2.2.3 Starting the engine with auxiliary starter switch**

**CAUTION**

- For starting the engine with auxiliary starter switch in use, have the main starter switch placed in ON position.
- Do not continue to turn the starter for more than 5 seconds. It will accelerate the discharging of the battery. If the engine fails to start, wait for about 2 minutes before giving it a try again.
- Before starting the engine make sure that the fuel lever of water separator pot is in vertical position (Open).
- Make sure that main switch in radio control system box is at OFF position.

1. Insert key into main starter switch and turn it to ON position.

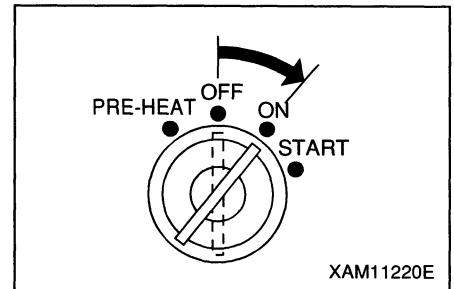

2. Pull back the accelerator lever at crane control system to the medium engine speed zone (about midway).

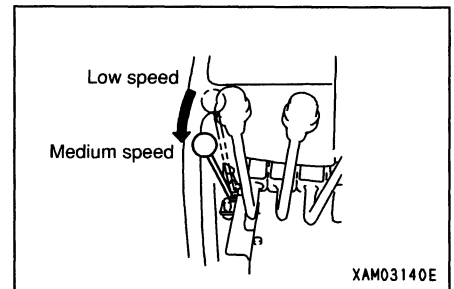

3. Push the auxiliary starter switch upward.

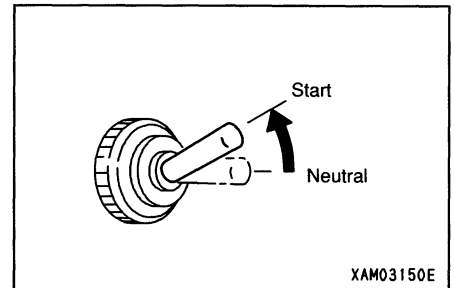

4. If the engine starts, release the auxiliary starter switch and the switch will return to Neutral position automatically.

**NOTES**

If your engine is difficult to start, see “OPERATION, 2.2.1 Start the engine with main starter switch” and use the main switch to start it.

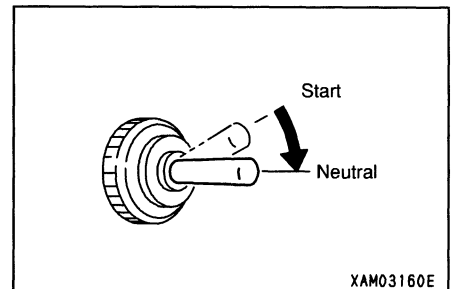

## 2.3 Operation and checking after starting engine has started

**! DANGER**

While engine is running, never replenish with fuel (light oil).  
Be sure to stop the engine for refueling.

**! WARNING**

- If any trouble develops during warm-up run, promptly turn the main starter switch to OFF position for an emergency stop. Engine will stop and power for electric system will go off.
- Make sure to conduct warm-up run. Particularly in cold climate, sufficient warm-up run is essential. Without it, reaction to control lever by travel or crane system will be slow, leading to serious accident.
- After warm-up run, be sure to check actuation of crane function. While doing so, use care to avoid interference or collision between hook block and boom.
- If any abnormality should be detected during these functional check, promptly make the emergence stop for required repair. Operating the crane with abnormality remaining may lead to serious accident.

**CAUTION**

- It is appropriate that hydraulic oil is used in the temperature range of 50 to 80°C. Even when you have to work in low temperature, at least the oil temperature should be raised to 20°C before starting your work.
- Do not race the engine in haste until warm-up run is completed.
- After engine has started, check that charge monitor lamp has gone off. If not, correct the situation.
- Running engine for long time at low speed may cause trouble due to lack of lubrication at cylinder head.  
When you use engine at low speed, race the engine once a day for about 5 minutes.

Once the engine starts, perform warm-up run in the following procedure:

1. Push the accelerator lever downward (all the way to the stroke end) to place the engine at low speed and run it at idling speed for about 5 minutes.
2. Check for abnormal exhaust color, sound or vibration of the engine and correct it as necessary.
3. Pull back down the travel lever stand so that lock lever ① is in Crane Work position.
4. Set up the outrigger.
  - ★ See “OPERATION, 2.12 Set the outrigger” for detail.
5. Loosen the wire rope which has been locking the hook block, before disengaging the hook block from its hanger.
  - ★ See “OPERATION, 2.14 Operation before crane work” for detail.

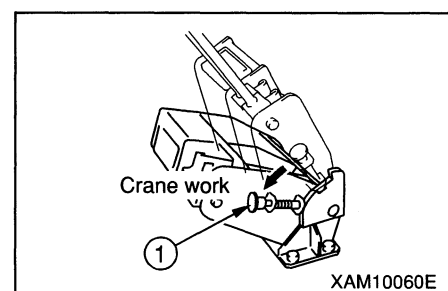
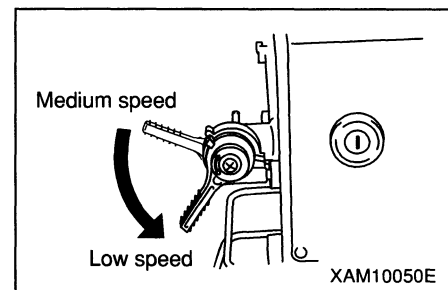

6. Pull back the accelerator lever on the crane control side to place the engine at medium speed (midway).

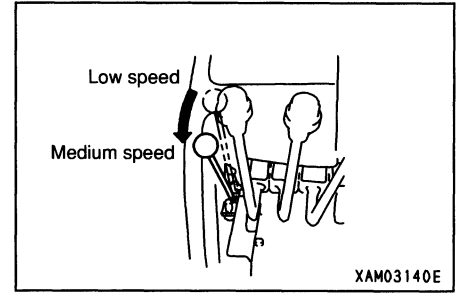

7. Slowly operate the boom hoist lever back and forth so that hoist cylinder extends and retracts to its stroke end to check that its function is normal. If not, correct it as necessary.

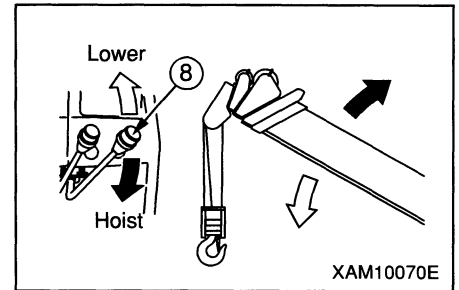

8. Slowly operate boom telescope cylinder back and forth so that the boom extends or retracts to its stroke end to check that its function is normal. If not, correct it as necessary.

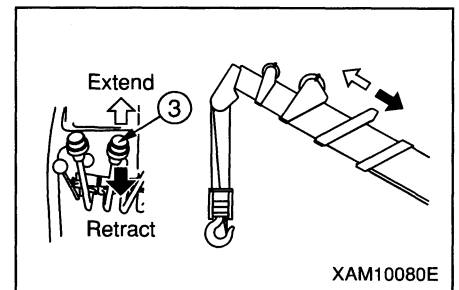

9. Slowly operate winch lever back and forth to check that hook block is hoisted and lowered smoothly, that it stops immediately when the winch lever is returned to Neutral position and that the winch does not take up the rope in disorderly manner. Correct any abnormality as necessary.

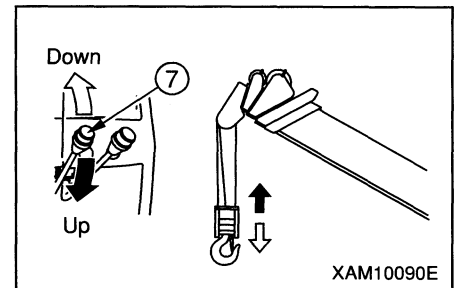

10. Slowly operate swing lever back and forth to check that the crane swings clockwise and counterclockwise smoothly more than 360 degrees respectively and that it stops immediately when the swing lever is returned to Neutral. Correct any abnormality as necessary.

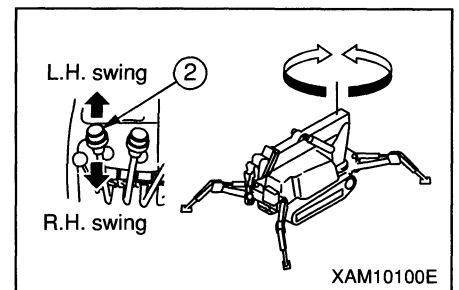

## 2.4 Break-in operation

### ! CAUTION

**Perform break-in operation with this machine during the first 250 hours on service meter. Overloading the machine before various part of machine adapts to operation, may shorten its useful life.**

While this machine is shipped after having gone through sufficient adjustment and inspection, forcible operation during early stage of usage invites pre-matured deterioration in engine or crane performance, resulting in their shortened useful life. It should undergo break-in operation for the first 250 hours or so on service meter. During the break-in period, observe following rules in particular:

- After starting up the engine, be sure to perform warm-up run and avoid racing it in accordance with “OPERATION, 2.3 Operation and check after starting the engine”.
- Avoid working while overloading it or at high speed.
- Avoid rapid start, rapid acceleration, unnecessary sudden stop or rapid change of travelling direction.
- When break-in period reaches 250 hours, be sure to change engine oil in accordance with “MAINTENANCE, 8.3 [1] Change engine oil”. Metal particles due to adaptation of engine internals increase within engine oil to deteriorate the engine oil and shorten the useful life of the engine.

## 2.5 Travel position of the machine

### ! WARNING

- **To move this machine by self-travelling, let the machine assume Travel Position with boom, hook block and outrigger stowed.**
- **Travelling with boom extended or with a load suspended, is prohibited. It may cause tipping over and serious accident including injury or death.**
- **Do not use this machine for other than its primary purpose, such as carrying package placed on it.**
- **As for driving this machine on public road, see local regulation.**

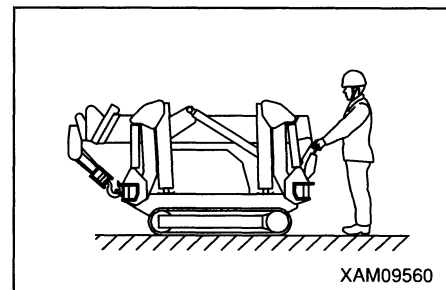

When moving this machine, let it assume travel position as shown in drawing to the right.

1. Stow the crane and lock the hook block at prescribed location.
  - ★ See “OPERATION, 2.22 Stow the crane” for detail.
2. Stow away all the outriggers.
  - ★ See “OPERATION, 2.23 Stow the outrigger” for detail.
3. Turn the switch ② of over-hoist alarm buzzer ① to OFF position.

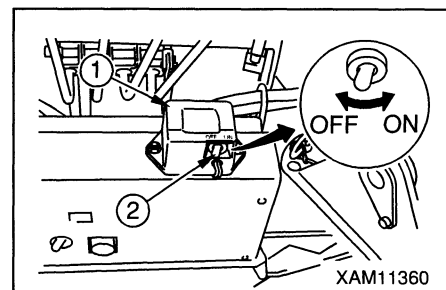

## 2.6 Starting the machine

### **! WARNING**

- Do not allow any person to approach the machine.
- Remove any obstacle in its travelling path.  
Particularly, make sure that the path for travelling backward is free from any hump that may cause stumbling or any ditch, and improve the terrain.
- Before starting the machine, make sure of the safety around it and sound the horn.
- This machine is designed so that, simultaneously with starting of the machine, operator is to move along.  
When letting the machine start, adjust the engine to low speed and operate right and left levers simultaneously and slowly, to check the travel speed of the machine. In case of travelling backward in particular, avoid abrupt start, which may result in serious accident.
- Immediate front of the machine will become a blind spot. Pay special attention when travelling forward.
- In case your travelling direction is in a blind spot and you can not make certain of the safety, stop the machine once and check for the safety before continuing to travel. Place a guide, depending on the job site situation.
- While travelling, work selector switch should be placed in Travel position and travel lever locking lever ① in Free position.

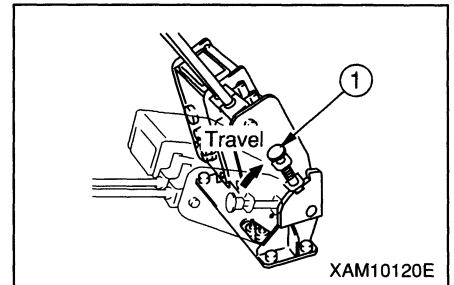

#### [1] Forward travel

Operate travel levers, right and left, simultaneously.

- Slowly push the right and left travel levers forward to start.

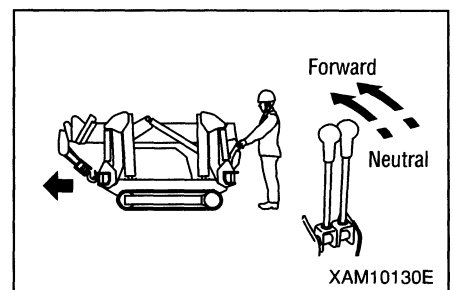

#### [2] Reverse travel

Operate the travel levers, right and left, simultaneously.

- Slowly pull back the right and left travel levers to start.

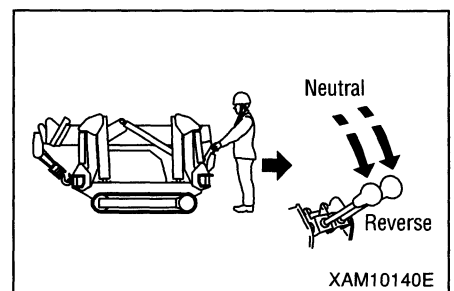

## 2.7 Change travel direction of the machine

### **! WARNING**

- **Rapidly changing travel direction at high speed or unnecessary spin turn not only damages rubber track or hydraulic system, may cause collision with other object. Before making spin turn, bring the machine to a complete stop and adjust engine to low speed.**
- **Changing travel direction on slope should be avoided as it is likely to cause a side skidding. Be extra careful over soft or clay ground.**

#### [1] Changing direction of the machine while it is standing still:

- **For making left turn:**

Operate the travel lever on your right hand side.

Pushing it forward causes the machine to turn left in the direction of travelling forward.

Pulling it back causes the machine to turn left in the direction of travelling reverse.

- **For making right turn:**

Operate the travel lever on your left hand side.

Pushing it forward causes the machine to turn right in the direction of travelling forward.

Pulling it back causes the machine to turn right in the direction of travelling reverse.

#### [2] Making a spin turn:

- **For making a counterclockwise spin turn:**

Pushing right travel lever forward and pulling left travel lever back simultaneously causes both rubber tracks to rotate in opposite direction to make counterclockwise spin turn.

- **For making clockwise spin turn:**

Pushing left travel lever forward and pulling right travel lever back simultaneously causes both rubber tracks to rotate in opposite direction to make clockwise spin turn.

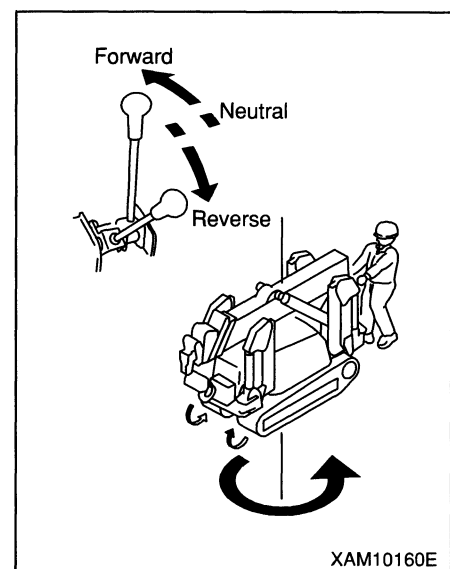
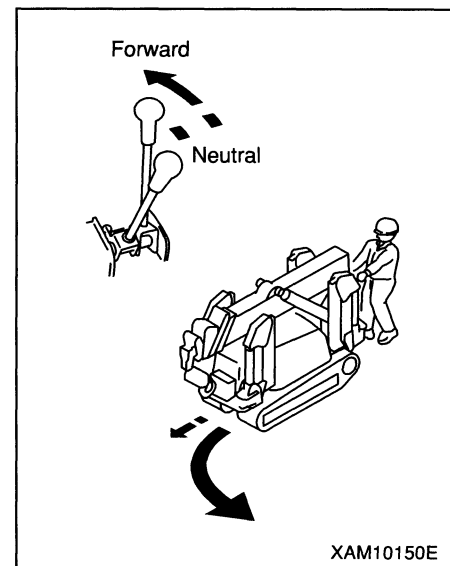

**[3] Changing travel direction while travelling forward or reverse:**

- **For making left turn while travelling forward:**  
With the right travel lever pushed forward, return only the left travel lever to Neutral.
- **For making left turn while travelling reverse:**  
With the right travel lever pulled back, return only the left travel lever to Neutral.
- **For making right turn while travelling forward:**  
With the left travel lever pushed forward, return only the right travel lever to Neutral.
- **For making right turn while travelling reverse:**  
With the left travel lever pull back, return only the right travel lever to Neutral.

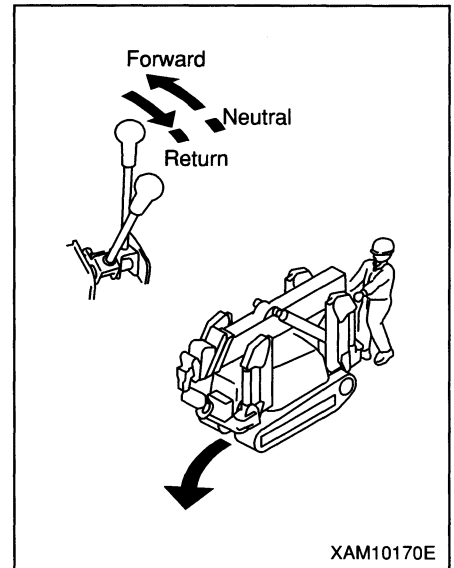

**2.8 Stopping and parking the machine**

**⚠ WARNING**

- **Avoid making sudden stop and bring the machine to stop slowly where possible.**
- **Select hard and level ground for parking the machine. If you have to park it on slope, engage chock to prevent it from rolling.**
- **As long as the engine is running, touching the travel lever carelessly causes the machine to start suddenly to result in serious accident.**
- **Before leaving the machine, shutdown the engine and be sure to remove the main starter key.**

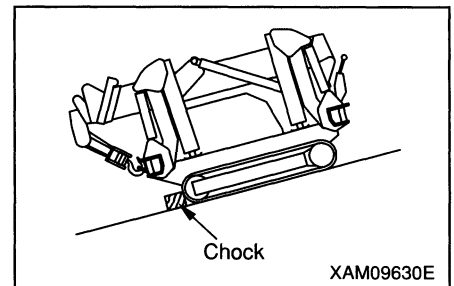

1. Placing both right and left travel levers in Neutral simultaneously, causes the brake system to be applied automatically for the machine to come to stop.

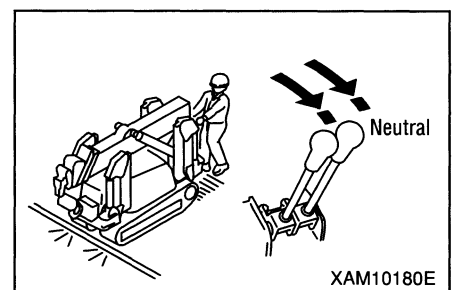

## 2.9 Stopping the engine

### CAUTION

- Stopping the engine before it is sufficiently cooled may shorten useful life of its various part. Do not stop it abruptly except for emergency.
- When your engine is overheated, do not stop it immediately but run it at medium speed to gradually cool it before shutting it down.
- Make sure that the main switch in radio control box is in OFF position.

1. Push the accelerator lever downward (all the way to the stroke end) to place engine at low speed and run it at idling speed for about 5 minutes.
2. Turn the key in main starter switch to OFF position. Engine will stop.
3. Remove the key of main starter switch.

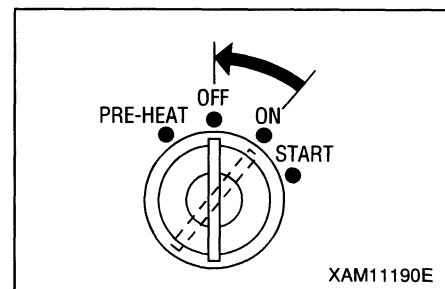
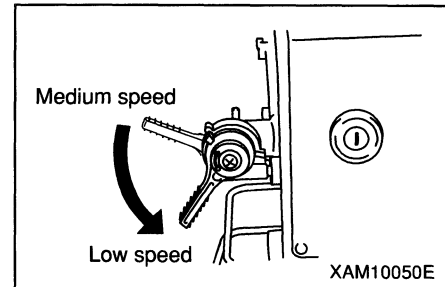

## 2.10 Inspection and check after stopping the engine.

1. Check for oil and water leakage, and visually check undercarriage, crane and other externals. Correct any abnormality.
2. Fill-up the fuel tank.
3. Fallen leaves or trash deposited around engine should be removed as it may cause fire.
4. Remove dirt deposited around undercarriage and outrigger.



## 2.11 Rules for travelling

### **! WARNING**

**Neglecting these rules for travelling will result in serious accident.**

#### [1] Rules for travelling

Climbing over obstacle such as boulder or stump gives the machine (undercarriage in particular) a great impact and creates the cause for damage.

Avoid such obstacle or remove it not to climb over it where possible.

When inevitable, be sure to let the machine assume Travel position to lower its center of gravity and slow down the travel speed as much as possible, before going over using the center of each track.

★ See "OPERATION, 2.5 Travel Position of the machine" for detail.

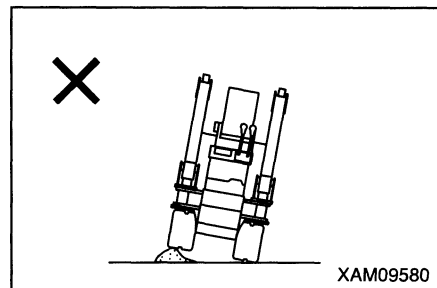

#### [2] Permissible depth of water

For underwater work, this machine may be used to the depth of the center of idler ①.

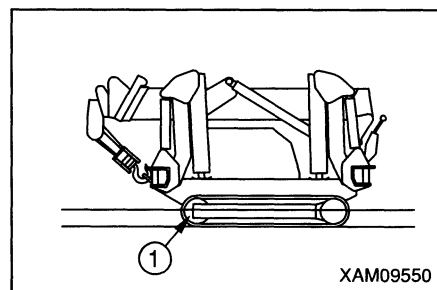

#### [3] Rules for uphill or downhill operation

### **! WARNING**

**If the machine tilts 15 degrees in any direction during traveling, tipping over alarm sounds. If you hear alarm buzzer, stop traveling. Continuing traveling may cause tipping over of the machine.**

- Travelling on any slope steeper than 15 degrees should be avoided as it may cause tipping over.
- Never attempt to change direction on or while going across slope. Go down to flat land first or detour for the safety.
- For going downhill, reduce travel speed as much as possible with combined use of accelerator pedal and travel lever. While placing travel lever in Neutral causes the brake system to be applied automatically, going downhill at high speed may result in overrunning.
- For travelling on slope, be sure to position the machine at right angle to the slope and operator should operate from hill side of the machine..
- If engine stops in the middle of slope, place the travel lever in Neutral before attempting to start the engine.

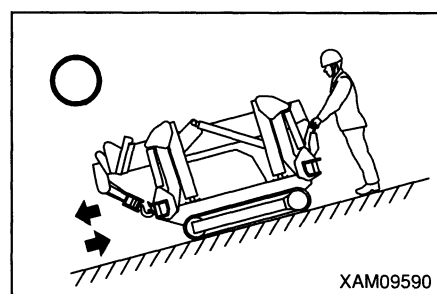
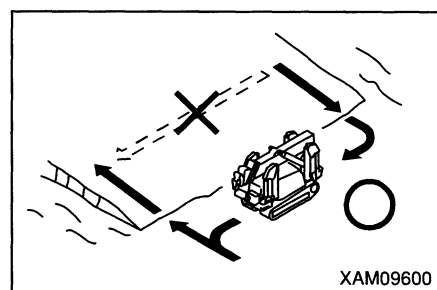

## 2.12 Setting up the outrigger

**! WARNING**

- For setting up the outrigger, select hard and level ground where possible. If you must set the outrigger inevitably on soft ground, place hard plates under the outrigger floats so that the outrigger does not sink during crane work.
- When setting up the outrigger, do not allow any person to approach it as a serious accident may result, such as your foot being caught by outrigger.
- When setting up the outrigger, be sure to watch leveling instrument so that levelness of the machine is secured. Outrigger should be set so that the rubber track is about 80mm off the ground. After setting up, press each of the four outriggers to make sure that load is being applied evenly.
- While outrigger of this machine can be placed freely in accordance with terrain, in case it is impossible to place it in "Outriggers extended to maximum" configuration, carry out your crane work in accordance with the value of "Total Rated Load Chart for Outriggers Extended to other than Maximum". Further, note that, depending on the outrigger placement angle, there are "crane work prohibited" zones, wherein your crane work should be avoided.
- Except for during outrigger telescoping operation (such as positioning pin placement or removal), work should be performed with the engine shutdown.  
If any outsider should inadvertently touch the outrigger switch, the outrigger cylinder may suddenly actuate and a serious accident may result.
- Before placing the outriggers, insert each positioning pin completely and retain it securely by engaging snap pins.
- Whenever you place the outrigger, do not fail to extend the outrigger top box.  
Do not extend outriggers with the top boxes remaining stowed.
- This machine has 4 outriggers. Be sure to use individual outrigger correctly. Check the relations between the numbers shown on Instruction Plate at the switch and number plate affixed on each individual outrigger. Incorrect operation can result in a serious accident.
- When you operate two outrigger switches simultaneously, operate two for front ([①] and [④]) and two for rear ([②] and [③]). Operating two switches of left and right side simultaneously may cause the machine to tip over.
- For floating the machine off ground, operate four outrigger switches in such manner as the four outriggers go up evenly and bit by bit. Floating rapidly with two outriggers on one side may cause the machine to tip over.
- Tilting of the machine steeper than three degree causes tipping over alarm buzzer to sound. Adjust the machine tilting so that it is placed in flat condition and the alarm buzzer stops.
- When operating the outriggers, run the engine at low speed. Leaving the engine at high revolution may cause the outrigger to actuate suddenly, inviting serious accident including tipping over of the machine.

**CAUTION**

- Before operating outrigger switch, push down the travel lever at travel control to place the locking lever in Crane Work position.  
So long as the locking lever remains in Travel position with the travel lever stand pushed forward, the outrigger is actuated only at very slow speed even if the outrigger switch is operated.
- When you disengage hook block from its hanger, do not excessively loosen the wire rope to such extent that the whole hook block lies down on the ground. It will be a cause for disorderly take up on the winch drum.
- Operating the outrigger switch causes outrigger mode indicator lamp to go on and warning buzzer to generate intermittent sound.
- Operating the outrigger switch causes the crane lever to move simultaneously, which does not represent any trouble.

[1] Components of outrigger

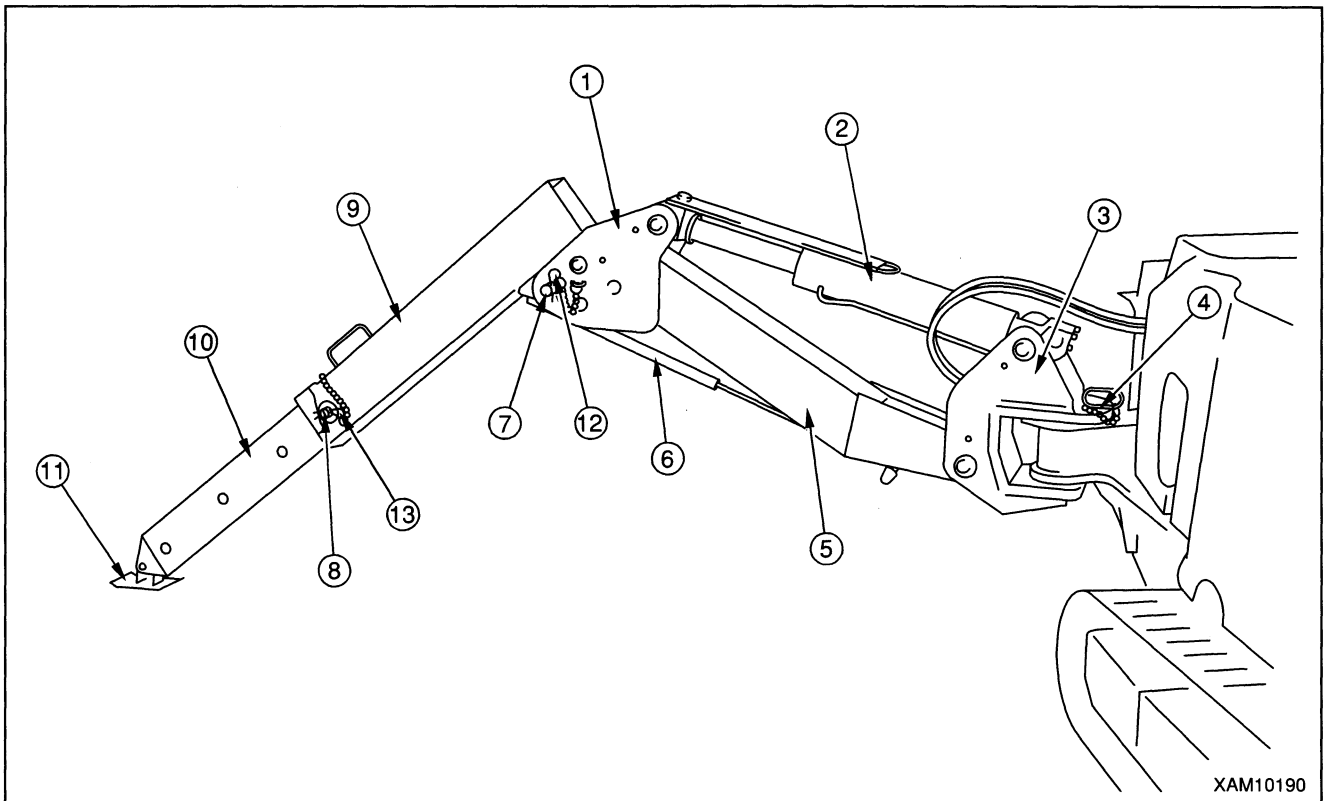

- |                                 |                             |
|---------------------------------|-----------------------------|
| ① Linkage bracket               | ⑧ Inner box positioning pin |
| ② Outrigger cylinder            | ⑨ Outrigger top box         |
| ③ Rotary                        | ⑩ Inner box                 |
| ④ Rotary positioning pin        | ⑪ Float                     |
| ⑤ Outrigger base box            | ⑫ Snap pin                  |
| ⑥ Stay (of damper type)         | ⑬ Snap pin                  |
| ⑦ Outrigger top positioning pin |                             |

[2] Steps to be performed with the engine shutdown

**⚠ WARNING**

When placing outriggers to maximum, the holes of rotary ③ to insert positioning pins ④ are different for the set of outriggers [①] and [②] and that of [③] and [④]. Read this section carefully to place the outriggers properly. In this section, steps to place the outriggers to maximum is presented.

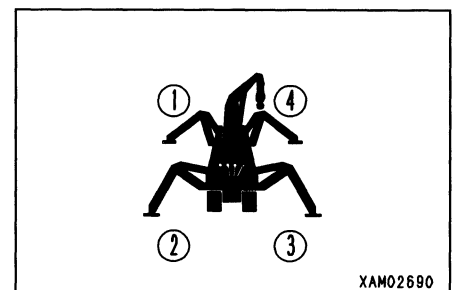

This machine has 4 outriggers. Method for setting up the outrigger is described below for the outrigger ③ only. The same applies to other 3 outriggers as well.

1. Pull out position pin ④ of rotary ③ and rotate the rotary outward.

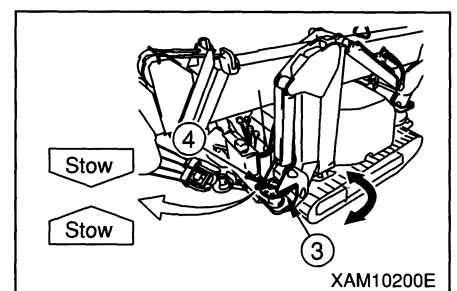

2. Turn the rotary ③ so that the seal “Standard” affixed to its side and the seal “Standard” affixed to the side of frame are aligned.
3. Insert positioning pin ④ to the hole where the seals “Standard” are aligned.

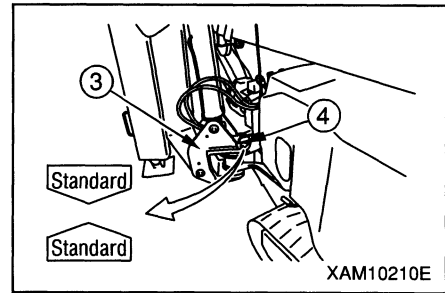

**NOTES**

- Positioning pin ④ has a ball chain for prevention of loss. Make sure that the ball chain is not caught by or crossing the top of frame. If it is, the positioning pin @4 will not go all the way into the pin hole of rotary ③ and may come off.
- If any hole other than where seals “Standard” meet is being utilized, outrigger extension should be regarded as “Other Than Standard Extension”. In this position, there are “work prohibited zones” and working within should be avoided.

4. Remove snap pin ⑫ at the end of positioning pin ⑦ of linkage bracket ① and pull out the pin ⑦.

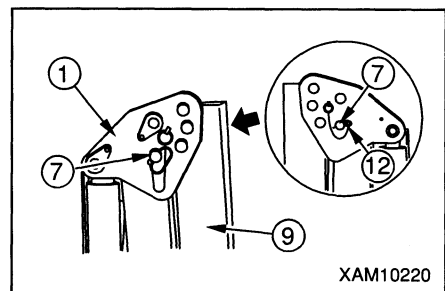

5. Lift up the top box ⑨ and align the hole of top box ⑨ with the position of the outermost hole on linkage bracket ①.

**NOTES**

The position of outermost hole on linkage bracket, means the one that has the seal “Maximum Extension” affixed to it.

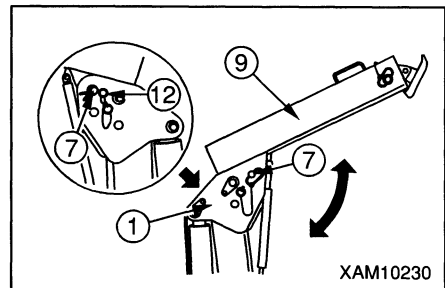

6. Insert the positioning pin ⑦ to the outermost hole on linkage bracket ① and retain it with the snap pin ⑫ at its end.

**NOTES**

If you use the outriggers by inserting the pin into any hole other than where with a sticker “Extended to maximum” at the pin of the coupled bracket, operate the machine in accordance with Rated Total Load with Outrigger Extended to other than Maximum.

- Remove snap pin ⑬ at the end of positioning pin ⑧ of top box ⑨ and pull out the positioning pin ⑧.

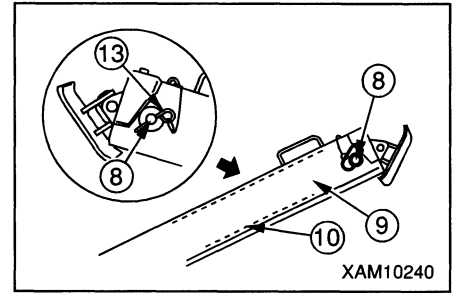

- Pull out the inner box ⑩ from top box ⑨ and align the hole on top box ⑨ with the position of innermost hole on the inner box ⑩.

**NOTES**

The position of innermost hole on inner box, means the one that meets the top box hole when the seal “Maximum Extension” affixed to the side of inner box is totally exposed.

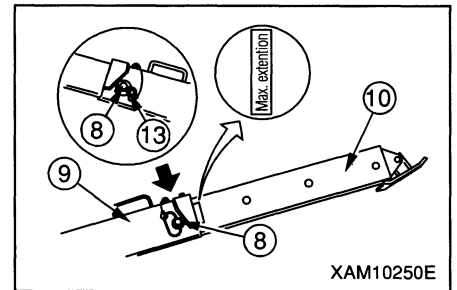

- Insert the positioning pin ⑧ to the hole of top box ⑨ and retain it with the snap pin ⑬ at its end.

**NOTES**

When the outrigger is set with the pin inserted to any hole other than that of Maximum Extension, work should be performed in accordance with Total Rated Load Chart for other than Maximum Extension”.

- Prepare other three outriggers in the same procedure.
- After completion of this preparation work, make sure that positioning pins are securely inserted to each hole with retainers engaged.

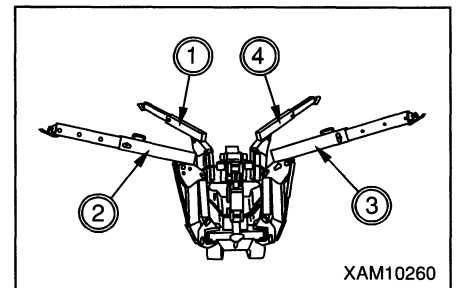

[3] Works to be done after starting engine

**! WARNING**

**Tilting of the machine steeper than three degree causes tipping over alarm buzzer to sound. Adjust the machine tilting so that it is placed in flat condition and the alarm buzzer stops.**

1. Start the engine. See "OPERATION, 2.2 Starting the engine" for detail.
2. Push down the travel lever stand and place the lock lever ① in Crane Work position.
3. Check the number on instruction plate of outrigger switch and decide the outrigger you desire to actuate.
4. Push the accelerator lever forward to run the engine at low speed.

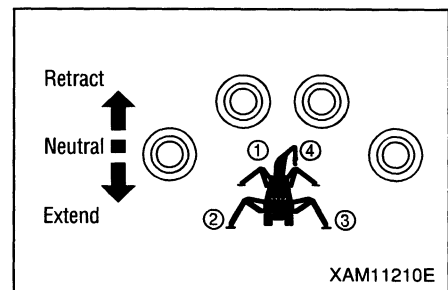
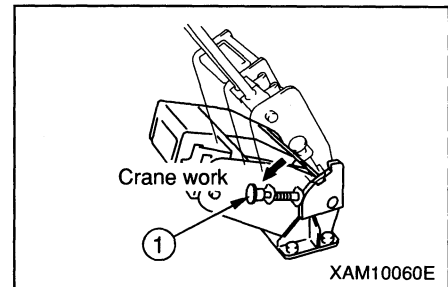

5. Push down the outrigger switch individually or two at a time. When the set up cylinder is extended for the float to be grounded, place the switch at Neutral. Operate other switches in the same manner so that floats of all the four outriggers are grounded before placing each switch at Neutral.

6. After grounding all the floats, push the outrigger switch individually or two at a time. When the machine is slightly lifted with the set up cylinders extended, place the switch at Neutral. Operate other outriggers in the same manner so that 4 outriggers are lifted to the same height and place the switch at Neutral. Repeat this operation to gradually lift the machine off the ground until the rubber track is at 80mm high.

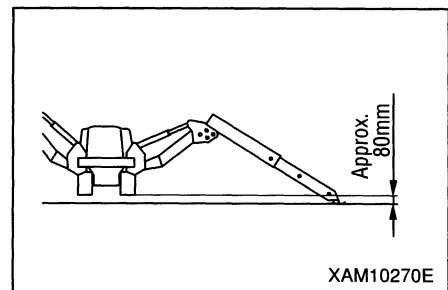

7. When the machine reaches about 80mm off the ground, while watching leveling instrument, operate the outrigger switches until the machine is level.

8. Upon completion of outrigger setting, place all the outrigger switches at Neutral.

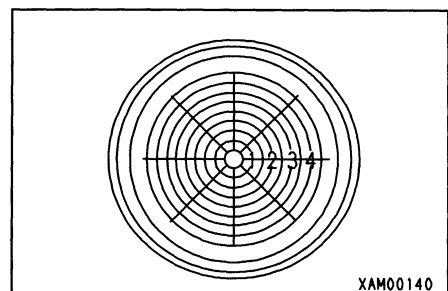

**2.13 Matters to be known before starting crane work**

**! WARNING**

**Negligence of following matters may lead to serious accident.**

- Place the switch ② of over-hoist alarm system ① at ON position. If this switch is in OFF position, the alarm will not sound even when the hook block is over-hoisted.
- Over-hoisting the hook block causes the warning buzzer of over-hoist alarm system to sound. If the buzzer sounds, release the winch lever ⑦ immediately to have it return to Neutral and stop hoisting.

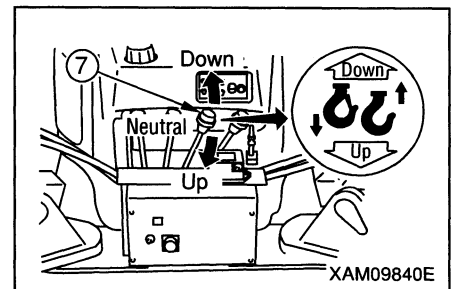
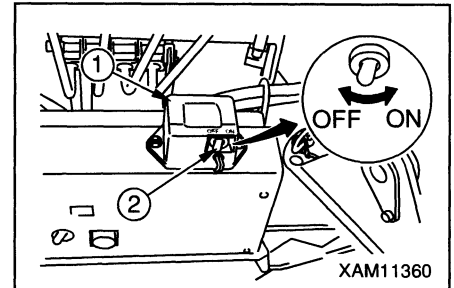

After that, push the winch lever ⑦ forward to Down position and lower the hook block.

- Extending the boom causes the hook block to be hoisted and buzzer of over-hoist alarm system to sound. If the buzzer sounds, release the boom telescoping lever ③ and let it return to Neutral so that the motion of boom extension stops.

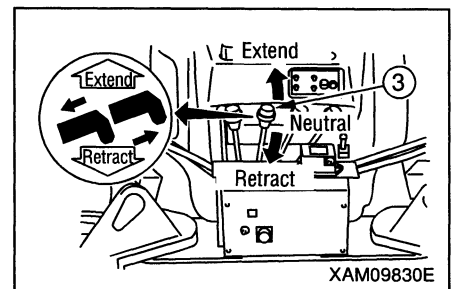

After that, pull back the boom telescoping lever e to Retract position and retract the boom.

Likewise, if boom is hoisted, hook block will be hoisted and buzzer of over-hoist alarm system will sound

If the warning buzzer sounds, release the boom hoist lever ⑧ immediately so it returns to Neutral and the boom hoist action stops.

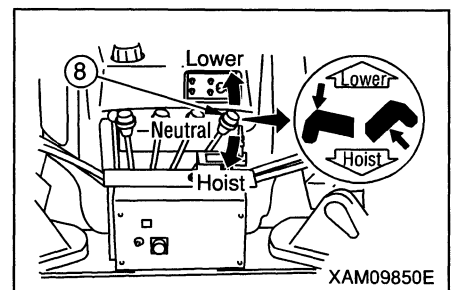

- During crane work, if you need to warn the surroundings about the danger, press horn switch to sound the horn.
- Make sure that all the outriggers are extended properly.

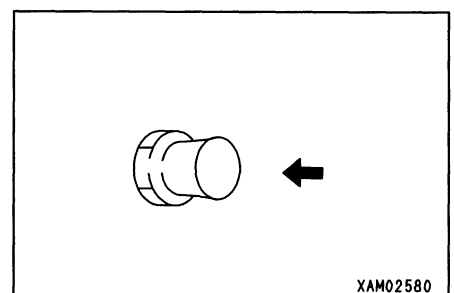

## 2.14 Operations prior to starting crane work

**CAUTION**

- Before operating various crane control levers or outrigger switches, push back down the travel lever stand on the side of travel control and place the locking lever in Crane Work position. If the travel lever stand is pushed forward and locking lever is placed in Travel position, any of these control levers or outrigger switches will not actuate.
- When lowering hook block from stowed location, do not allow the whole hook block to lie on the ground by loosening the wire rope excessively. It constitutes the cause for disorderly take-up on winch drum.

Before proceeding to your crane work, take the following steps:

1. Push back down the travel lever stand and place the lock lever ① at Crane position.
2. Place the winch lever ⑦ to Down position to loosen the wire rope which has been locking the hook block.
3. Disengage the hook block ④ from its hanger ③.

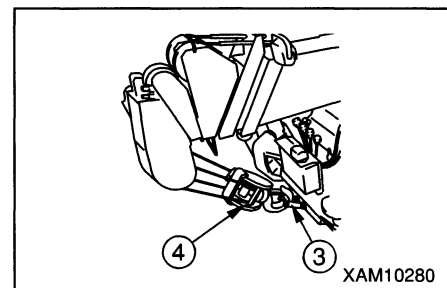
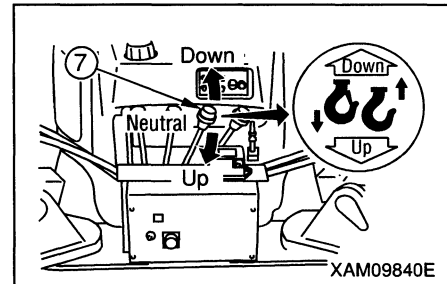
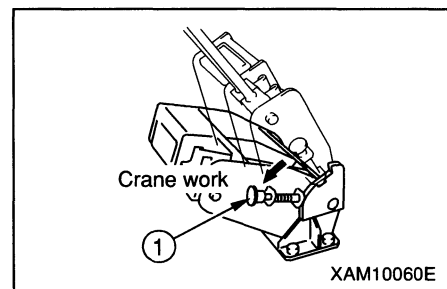



**2.15 Crane work position**

Upon completion of “Operations prior to starting crane work” in preceding section 2.14, let the machine assume Crane Work Position in the following procedure:

1. Operate the winch lever ⑦ to Down position and lower the hook block to the extent that it is not grounded.
  
2. Operate the boom hoist lever ⑧ to Hoist position and hoist the boom to such angle where hook block is not over-hoisted or grounded.

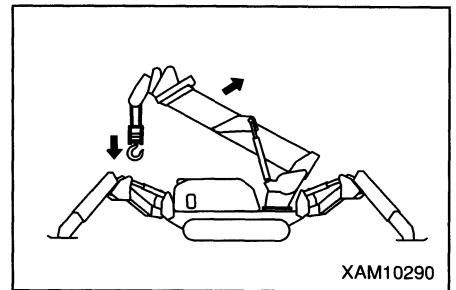
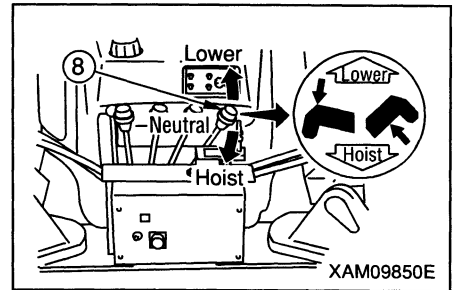
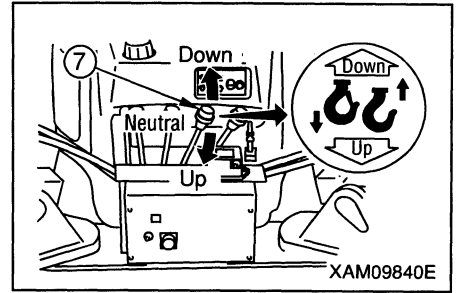

## 2.16 Hoisting and lowering operation

### ! WARNING

- When lifting a load, the load will move slightly forward due to bending of the boom. Wiring personnel should be aware of this.
- Over-hoisting the hook block causes the over-hoist alarm buzzer to sound. If the buzzer sounds, immediately place the winch lever in Neutral to stop hoisting.
- When you lower the hook way down for underground work or the like, you should leave the wire rope at least 3 windings on the drum.

### CAUTION

Do not ground the hook block. It may cause wire rope to be wound disorderly on the drum to cause damage.

Operate the winch lever ⑦ in the following procedure:

- Lowering: Push the lever forward to Down position.
- Neutral: Take your hand off the lever. Lever will return to Neutral position and hoisting or lowering of the hook block will stop.
- Hoisting: Pull back the lever to Up position.

### NOTES

Adjust the winch hoisting or lowering speed with the stroke of winch lever and acceleration lever.

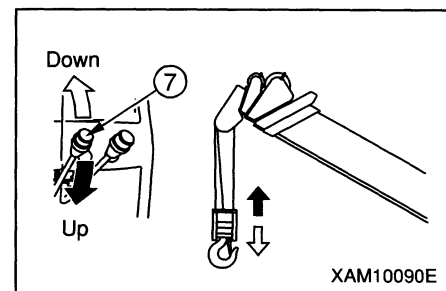

## 2.17 Boom hoisting and lowering operation

### ! WARNING

- Boom hoist lever should be operated as slowly as possible. Rapid lever operation particularly with a load lifted, will cause the load to sway and machine to incur big shock, resulting in damaging the crane or tipping it over.
- When hook block is hoisted in excess, over-hoisting is detected causing the horn and voice to sound. When you hear the horn and voice, immediately return the winch lever to neutral to stop hoisting.
- Lowering the boom causes the working radius to increase and liftable rated total load to reduce. When you work while hoisting or lowering the boom, use care that the mass (weight) of load does not cause over-loading when the boom is lowered.

Operate the boom hoist lever ⑧ in the following procedure:

- Lowering: Push the lever forward to Lower position.
- Neutral: Take your hand off the lever. Lever will return to Neutral position and hoisting or lowering of the boom will stop.
- Hoisting: Pull back the lever to Hoist position.

### NOTES

Adjust the boom hoisting or lowering speed with the stroke of boom hoist lever and acceleration pedal.

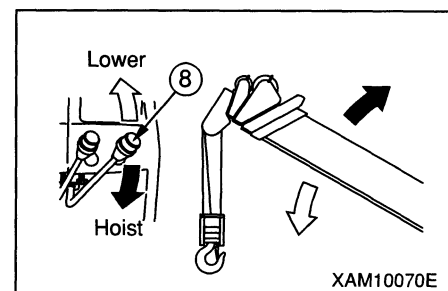

## 2.18 Boom telescoping operation

### **! WARNING**

- Operate the boom telescoping boom as slowly as possible. Rapid lever operation particularly with a load lifted, will cause the load to sway and machine to incur big shock, resulting in damaging the crane or tipping it over.
- Do not use boom telescoping action for dragging a load laterally or pulling it in.
- Extending the boom causes the working radius to increase and the liftable rated total load to reduce. When you work while telescoping the boom, use care that the mass (weight) of load does not cause overloading when the boom is extended to the maximum.
- While the boom is being extended, hook block will keep being hoisted. If the over-hoist preventive device buzzer sounds while you are extending the boom, place the boom telescoping boom in Neutral immediately to stop telescoping of the boom.

### **CAUTION**

- While the boom is being telescoped, the hook block will keep either being hoisted or lowered. Winch should be operated simultaneously to keep the hook block height adjusted.
- Leaving the boom extended for long time causes the boom to slightly to retract due to change in hydraulic oil temperature or the like. In such a case, boom length should be adjusted appropriately.

Operate the boom telescoping lever in the following procedure:

- Extending: Push the lever forward to Extend position.
- Neutral: Take your hand off the lever. Lever will return to Neutral position and telescoping of the boom will stop.
- Retracting: Pull back the lever to Retract position.

### **NOTES**

Adjust the boom telescoping speed with the stroke of boom telescoping lever and acceleration pedal.

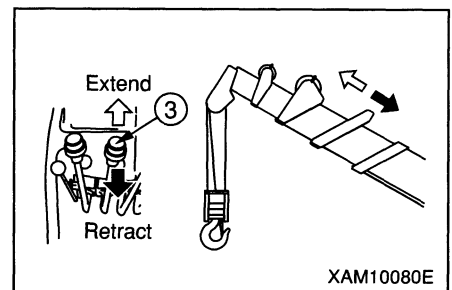

2.19 Swing operation

**! WARNING**

- Before making swing motion, be sure to ascertain the safety of surrounding by sounding the horn.
- Before making swing motion, be sure to ascertain the safety of surrounding by sounding the horn.
- Swing lever should be operated as slowly as possible.
- Always to try to start smoothly, swing at low speed and stop gently. Rapid lever operation with a load lifted will cause the load to sway and machine stability to be lost, resulting in damaging the crane or tipping it over.
- For swinging 360 degrees with a load lifted, always place outriggers in standard extending direction as shown to the right.  
Note that, even with the outriggers extended to maximum, lateral stability is not necessarily perfect.
- If it is difficult to extend outriggers in such configuration as shown to the right, make sure of the positions where certain load can be lifted and where not, before starting to lift.
- Depending on the extended condition of outriggers, boom hits them during swing operation, probably damaging crane or making the machine tip over.  
Be careful not to allow boom to hit them at swing operation.

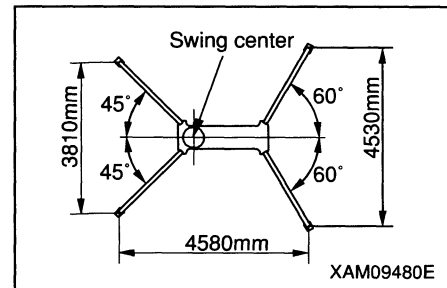

Operate the swing lever ② in the following procedure:

- Counterclockwise swing: Push the lever forward to L.H swing position.
- Neutral: Take your hand off the lever. Lever will return to Neutral position and the swing motion will stop.
- Clockwise swing: Pull back the lever to R.H.swing position.

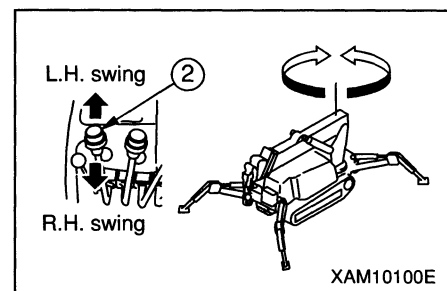

**NOTES**

Adjust the swing motion speed with the stroke of swing lever and acceleration pedal.

## 2.20 Accelerator pedal operation

### **! WARNING**

It is dangerous to increase speed of any crane action rashly.

### **CAUTION**

At the start or near the end of any action, reduce speed. Also adapt high or low speed to the load you are actually lifting.

Operate the accelerator lever ① in the following procedure:

- Low idling: Push the lever all the way forward. Pushing the lever forward causes the engine speed to drop and various crane motion also to be slowed down.
- Full speed: Pull the lever all the way back. Pulling back the lever causes the engine speed to increase and various crane motion also to so faster.

### **NOTES**

Release lever at the position of desired engine speed. Lever will stop right there.

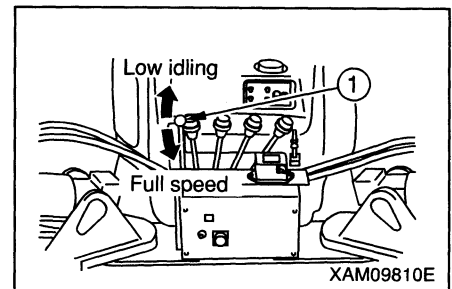

## 2.21 How to use load indicator and load meter

**! WARNING**

- Understand how to use the load indicator and load meter so you can perform your crane work safely, not exceeding rated total load.
- When you lift a load, if the pointer of load meter should exceed such rated total load as is read on load indicator, the load should be grounded immediately. Continuing to lift as it is, may cause the machine to be damaged or tipped over.
- If a load exceeds rated total load, reduce the working radius by either shortening the boom or hoisting the boom.

**[1] Usage of load indicator and load meter with “Outrigger extended to maximum”**

For performing crane work, read the rated total load on the load indicator and mass (weight) of the lifting load on the load meter in the following manner: Incidentally, the rated total load includes mass (weight) of hook block, 0.02 ton.

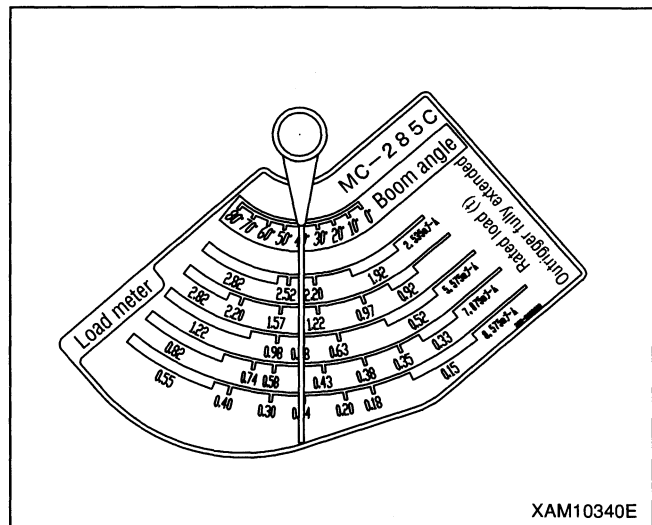

1. Operate boom hoist lever to hoist the boom before stopping at desired angle.
2. The boom angle should be read as the value where the column “Boom Angle” on the load indicator and pointer crosses each other.
3. Operate boom telescoping lever to extend the boom to desired length.
4. The rated total load should be read as the value where the “Scale of Boom Length in Use” in the column “Rated Total Load with Outrigger Extended to Maximum” on the load indicator and the pointer crosses each other.



XAM10340E

**[About boom length (Part 1)]**

Boom length (standard boom length) in Rated Total Load Table are given in ascending order.

- **2.535m boom**  
All booms are retracted.
- **4.075m boom**  
All third, fourth, and fifth booms are retracted, and second boom is in full extension.
- **5.575m boom**  
Third boom is extended to the extent that the first  mark is visible.
- **7.075m boom**  
Third boom is extended to the extent that the second  mark is visible.
- **8.575m boom**  
All booms are in full extension.

MC-285C Rated Total Load Table							
Rated Total Load with Outrigger Extended to Maximum							
2.535m/4.075m Boom		5.575m Boom		7.075m Boom		8.575m Boom	
Working radius (m)	Rated Total Load (t)	Working radius (m)	Rated Total Load (t)	Working radius (m)	Rated Total Load (t)	Working radius (m)	Rated Total Load (t)
1.4 below	2.82	3.0 below	1.22	3.6 below	0.82	4.0 below	0.55
1.5	2.52	3.5	0.97	4.0	0.74	4.5	0.4
2.0	1.92	4.0	0.78	4.5	0.58	5.0	0.34
2.5	1.57	4.5	0.63	5.0	0.48	5.5	0.3
3.0	1.22	5.0	0.53	5.5	0.43	6.0	0.27
3.5	0.97	5.205	0.53	6.0	0.38	6.5	0.23
3.705	0.92			6.5	0.35	7.0	0.2
				6.705	0.33	7.5	0.18
						8.0	0.15
						8.205	0.15
Rated Total Load of Outrigger Extended to other than Maximum							
2.535m/4.075m boom		5.575m boom		7.075m boom		8.575m boom	
Working radius (m)	Rated Total Load (t)	Working radius (m)	Rated Total Load (t)	Working radius (m)	Rated Total Load (t)	Working radius (m)	Rated Total Load (t)
1.5 below	1.72	3.0 below	0.51	3.6 below	0.4	4.0 below	0.33
2.0	1.07	3.5	0.41	4.0	0.33	4.5	0.28
2.5	0.63	4.0	0.33	4.5	0.28	5.0	0.23
3.0	0.52	4.5	0.28	5.0	0.23	5.5	0.18
3.5	0.43	5.0	0.23	5.5	0.18	6.0	0.16
3.705	0.35	5.205	0.2	6.0	0.16	6.5	0.15
				6.5	0.15	7.0	0.1
				6.705	0.14	7.5	0.08
						8.0	0.07
						8.205	0.06

XAM09470E

★ The above table is just for reference; the values may be different from actual ones.

**[About boom length (2)]**

If the actual boom length exceeds the boom length (standard boom length) in Rate Total Load Table, check the value in the next column to perform crane work.

For example, if you extend the boom more than **2.535m** boom even a little, see the next **4.075m** boom column.

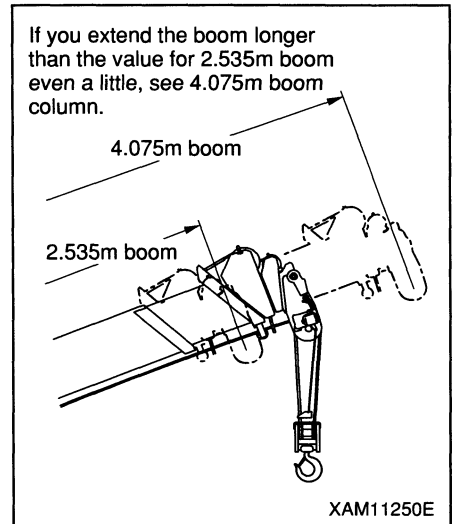

XAM11250E

5. While watching the lifting load and load meter, read the value on the load meter immediately after the load lifts off the ground (lift off). The load should be detected in the following manner:
- (1) Operate the winch lever to lift the hook block with no load engaged (no-load).
  - (2) Operate the accelerator lever to adjust engine speed so that the pointer of load meter indicates zero (0).

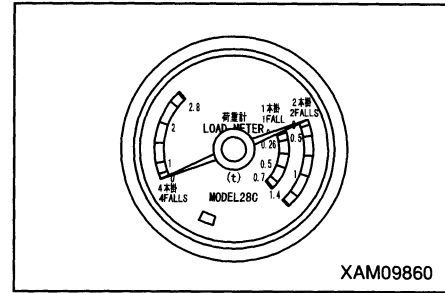
**NOTES**

Remember the position of the accelerator lever at this time.

- (3) Engage the lifting load with hook block and adjust engine speed to the value acquired in preceding paragraph (2).
- (4) Operate the winch lever and read the value indicated by the pointer of load meter immediately after the load lifts off the ground (lift off).

**NOTES**

It should be noted that the load meter indicates the weight of load being hoisted with winch only, but it does not indicate weight of load being lifted by any other means.

6. If the mass read on the load meter is less than such “Rated Total Load” of load indicator as was read with step 4 above, your crane work will be safe.

### [2] How to use load indicator with outrigger extended to midway or minimum:

When you work with outrigger configuration other than maximum extension, read the boom hoist angle by means of load indicator and based on such angle, read the working radius by means of Working Radius/Lifting Height Chart, and then read the load shown in the Total Rated Load Chart for other than Outrigger Extended to Maximum. Suppose the boom angle which is read on load indicator is 40 degrees, read the value of rated total load in the following procedure:

1. Read the working radius on the Working Radius/Lifting Height Chart for the case of boom length 5.575m and boom angle 40 degrees. The working radius for this case will be about 4.1m.
2. Read the value of rated total load from the Rated Total Load Chart for other than Outrigger Extended to Maximum, for the case where working radius is about 4.1m as read in the preceding subparagraph 1 for the boom length of 5.575m.

In case the working radius is about 4.1m, the rated total load of 280kg for the working radius 4.5m on the rated total load chart, will be the rated total load.

3. Read the weight of lifting load and if it is less than Rated Total Load, your work will be safe.



**2.22 Stowing the crane**

**CAUTION**

- Before lowering and engaging the hook block to its hanger, stop the swaying of the block.
- Before engaging the hook block to its hanger, do not loosen the wire rope excessively to avoid the whole hook block to lie down on the ground. It will be a cause for disorderly take up on the winch drum.
- When securing the hook block, do not tighten the wire rope excessively. It may damage wire rope or locking metalwork for the hook engagement. Insufficient tension may also cause the hook block to sway during travel and damage surroundings with interference.
- Retracting the boom places the hook block in such condition as if it were lowered. Also, lowering the boom causes the hook block to be lowered. To prevent the hook block from grounding or interfering with the machine, hoisting action should also be performed simultaneously.

1. Have the boom totally retracted.
2. Have the boom lowered all the way.
3. Place the switch ② of over-hoist alarm buzzer ① in OFF position to stop the buzzer sounding.
4. Push the winch lever forward to Down position and engage the hook portion of hook block ④ to its hanger ③.
5. Pull back the winch lever ⑦ and place it in Up position to hoist the hook block. Wire rope will pull the hook block so that the entire crane is secured.

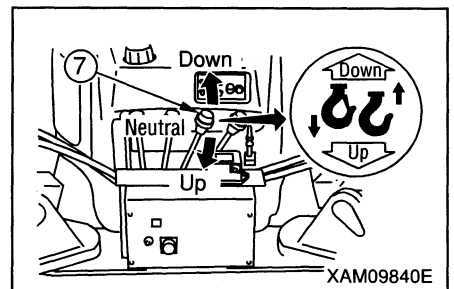
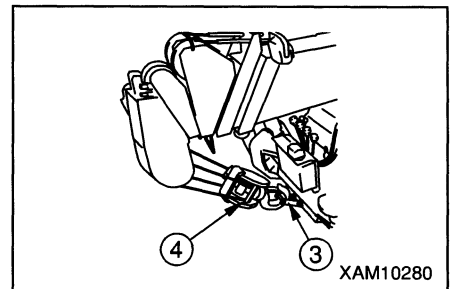
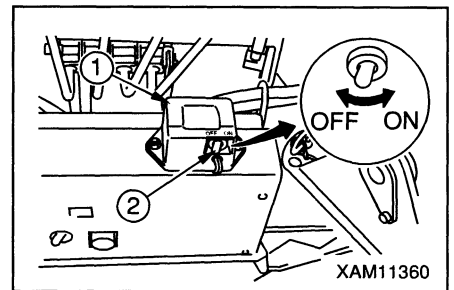

### 2.23 Stowing the outrigger

#### WARNING

- When stowing the outrigger, do not allow anyone to approach. Serious accident may result, such as being caught between the outrigger and basic machine.
- Any work other than outrigger cylinder extension and grounding, should be carried out with the engine shutdown. If someone inadvertently touches the outrigger switch, outrigger cylinder will actuate suddenly causing serious accident.
- Removing position pins causes box and bracket to rotate as they lose support. Be sure to hold them with single hand before pulling out position pins.
- When stowing the outrigger, do not allow your hand or finger to approach any gap of moving part. It may lead to serious accident such as being caught.
- To stow the outrigger, insert each positioning pin completely and retain them securely by means of snap pins.
- This machine has 4 outriggers. Do not mix up the use of 4 outriggers. Check the numbers shown on control plate at the switch with the number plates affixed to each outrigger. Improper operation will result in serious accident.
- When operating the outrigger, run the engine at low speed. Leaving it running at high speed causes sudden actuation of outrigger, resulting in serious accident including tipping over of the machine.
- When you lower floated machine to ground, operate 4 outrigger switches so that all the 4 outriggers are lowered evenly in small increments. Rapidly retracting 2 outriggers on one side causes the machine to be unstable and even to tip over.

#### CAUTION

- Operating the outrigger switch causes the outrigger mode indicator lamp to flash and warning buzzer to generate intermittent sound.
- Operating the outrigger switch causes the crane control lever to move simultaneously, which does not represent any trouble.

**[1] Procedures to be performed after starting the engine**

1. With your engine started and running:
  - ★ See “OPERATION, 2.2 Starting the engine” for detail.
2. Check the number on instruction plate of outrigger switch and decide the outrigger you desire to actuate.
3. Push up the outrigger set up switch, one of them at a time or two simultaneously, to ON position.
 

When, with the outrigger retracting, the machine starts to lower, place the switch in Neutral for the time being.

Operate the remaining switches in the same manner so that 4 outriggers rise to equal height, place switches in Neutral for the time being.

Repeat this operation to lower the machine gradually, until the rubber tracks are totally grounded.

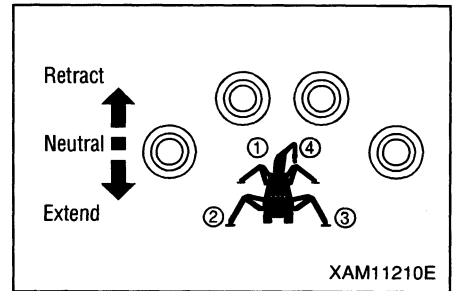

4. After both tracks are completely grounded, continue to push up the outrigger switch, one at a time or 2 simultaneously to IN position.
 

When, with the outrigger telescoping cylinder having retracted completely, the outer box ⑨ has reached upper limit, take your finger off the outrigger set up switch.

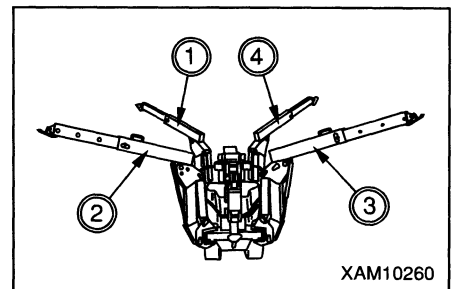

5. Push down (to Stop) the auxiliary starter switch and the engine will stop.

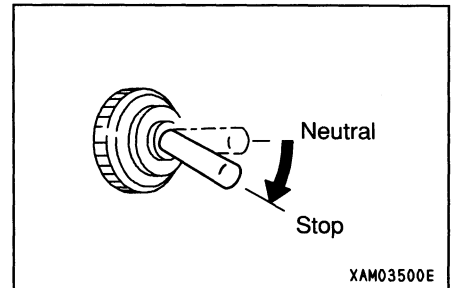

**[2] Procedures to be performed after engine has been shutdown.**

Although, the method for stowing outrigger is described hereunder with regard to the outrigger ③ only, follow the procedure for other 3 outriggers as well:

1. After removing snap pin ⑬ at the end of positioning pin ⑧ on top box ⑨, remove the positioning pin ⑧.
2. Push the inner box ⑩ into top box ⑨ and align the hole of the top box ⑨ with outermost hole position on inner box ⑩.
3. Insert positioning pin ⑧ to the hole of top box ⑨ and retain it with snap pin ⑬ at its end.

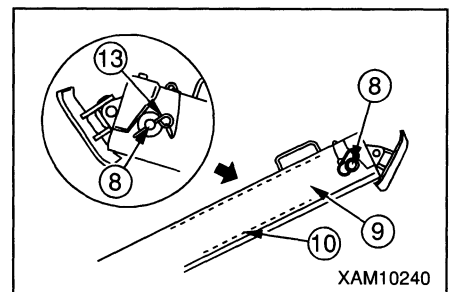
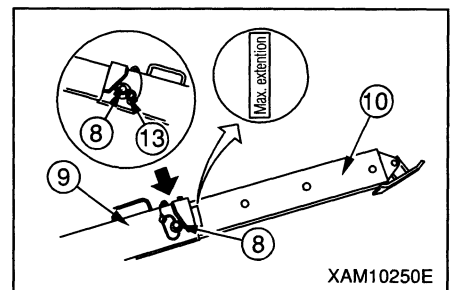

4. After removing the snap pin ⑫ at the end of positioning pin u of linkage bracket ①, pull out the positioning pin ⑦.

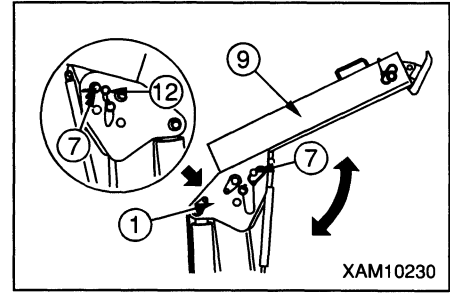

5. Lower the top box ⑨ and align the hole of top box ⑨ with innermost hole position of the linkage bracket ①.
6. Insert the positioning pin u to the innermost hole of linkage bracket ① and retain it with snap pin ⑫ at its end.

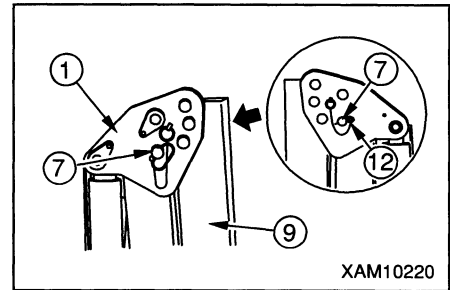

7. Pull out the positioning pin ④ of the rotary ③ and turn the rotary to inside.

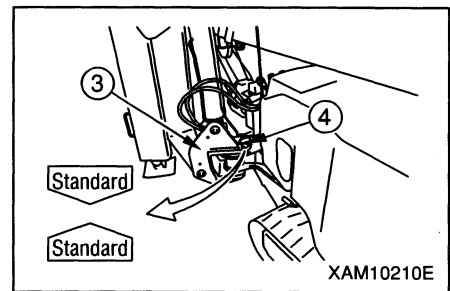

8. Turn the rotary ③ and align the seal “Stow” which is affixed to the side of rotary ③ with the seal “Stow” affixed to the side of frame.
9. Insert the positioning pin ④ to the hole where seals Stow are aligned.
10. Stow other three outriggers in the same procedure.
11. After stowing the outriggers, make sure that each positioning pin has been securely inserted and retained.

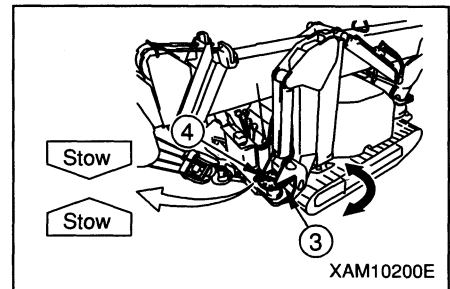

## 2.24 Matters prohibited in connection with crane operation

### ! WARNING

- Before starting your crane work, be sure to set outriggers on level and hard ground.
- Never attempt to let your crane travel with a load lifted or to perform crane work without placing outriggers. Machine will be exposed to unstable condition, leading to serious accident including tipping over.

★ Besides the prohibitions described in this section, see various rules of operation shown in Part II Safety.

#### [1] Prohibition of working with swing force in use.

Dragging in or pulling to erect a load by means of swing motion is prohibited.

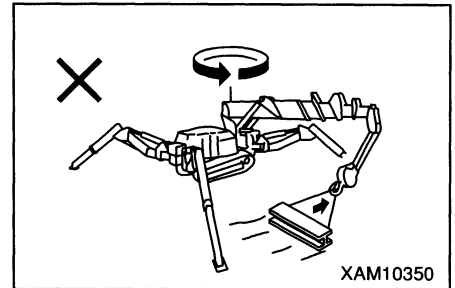

#### [2] Prohibition of working with boom hoisting force in use.

Dragging in or pulling to erect a load by means of boom hoist motion is prohibited.

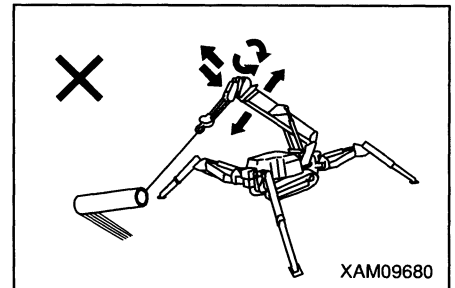

#### [3] Prohibition of working with lateral pulling, drawing, or lifting in angle

Work of lateral pulling, drawing or lifting at angle should be avoided as it applies unreasonable force to the machine. Not only it is likely to damage the machine, it is dangerous. Make sure that the hook comes directly above the center of gravity of the load.

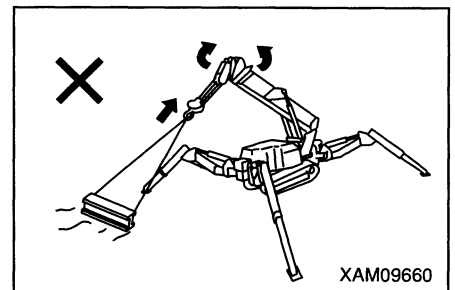

#### [4] Prohibition of violent operation during work

Do not operate any lever abruptly. Particularly, swinging, boom lowering and winching down should be performed slowly.

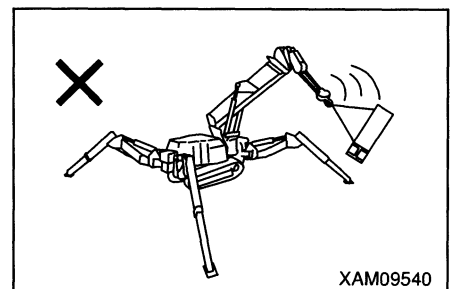

**[5] Prohibition of entering inside working radius**

Do not allow any one to approach inside working radius such as allowing to enter underneath a lifted load.

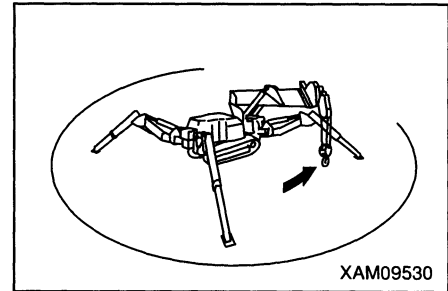

**[6] Prohibition of use for other than primary purpose**

Do not use crane as a lifter for personnel or the like.

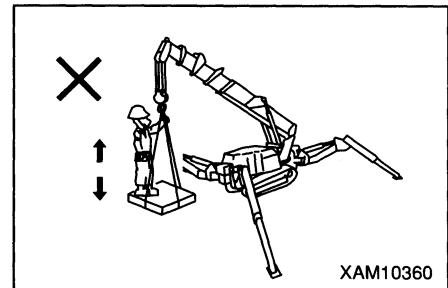

**[7] Prohibition of unreasonable work**

Any work beyond the capability or the machine leads to trouble. Crane work in particular should be performed in accordance with rated total load chart.

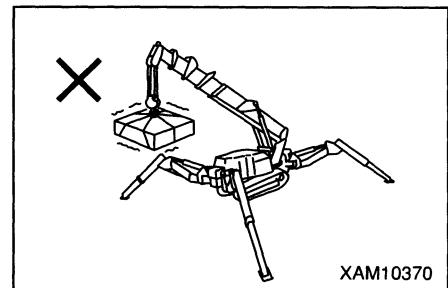

**[8] Prohibition of forcible wire rope hoisting**

Be careful for wire rope not to be caught by tree, steel structure or the like during work. Should it be entangled with something, do not forcibly hoist but disentangle it before resuming to hoist.

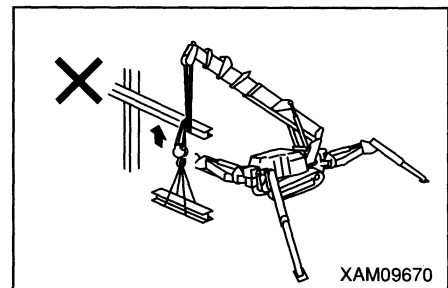

**[9] Prohibition of travelling with a load lifted**

Letting your crane travel with a load lifted or perform crane work without outrigger placed, may result in its tipping over and should be avoided absolutely.

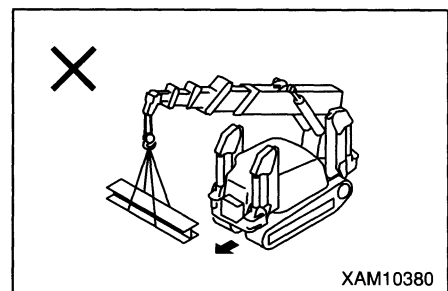

### 3. Handling of Rubber Track

#### 3.1 Smart way of using it

Rubber track is provided with excellent features which steel track lacks. However, when used similarly with steel track, such feature can not be fully utilized. Proceed with your work within its capability according to job site conditions or type of work.

#### NOTES

This machine is provided with rubber track as the standard supply and no option of steel track is available.

#### Comparison between rubber and steel tracks

Feature	Rubber track	Steel track
Vibration small	◎	△
Travelling smooth (no squeak)	◎	○
Noise level low	◎	△
No harm to road surface	◎	△
Service is simple	◎	△
Not prone to damage	△	◎
Traction great	◎	◎

◎: Excellent    ○: Good    △: Fair

While rubber track, due to its particular performance resulting from its material, demonstrates various advantages, it has inherent weak point relevant to strength as well.

Consequently, if you fully understand the features of rubber track and observe prohibitions and rules on its handling, its useful life will be extended to the maximum while exerting its advantages also to the maximum.

Prior to using it, be sure to read "OPERATION, 3.3 Prohibited type of works" and "3.4 Rules for usage".

#### 3.2 Warranty

Any damage is excluded from the range of warranty by supplier which is attributable to negligence by user including but not limited to failure to fulfill the requirement for inspection and services with respect to proper tension of rubber track or to observe prohibitions and rules such as "Not to work on corners of steel plate, U-shaped groove or blocks or at job site where cutting-up is likely to occur due to sharp edge of crushed stone,

### 3.3 Prohibited types of work

Following works are prohibited:

- Working and making turn on crushed stone sub-grade, hard jagged rock-bed, steel reinforcement member, steel scrap or near steel plate edge, will damage the rubber track.
- At such job site as river location where great deal of boulders of various sizes are in existence, pebbles are likely to lodged and damage rubber track or to cause the track to come off.
- Do not allow oil or chemical solvent to get on rubber track. Wipe it off. Do not travel over oil or the like gathered on road surface either.
- Do not enter such place where temperature is high as bonfire, steel plate left in the blazing sun or newly paved asphalt.
- For long term storage, keep it indoors where it will not be exposed to direct sun or rain.

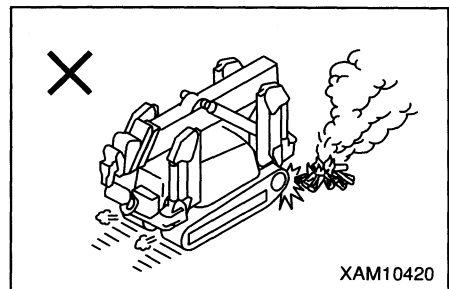
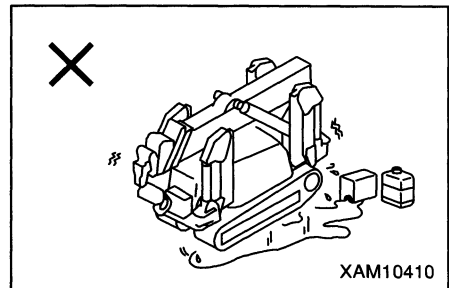
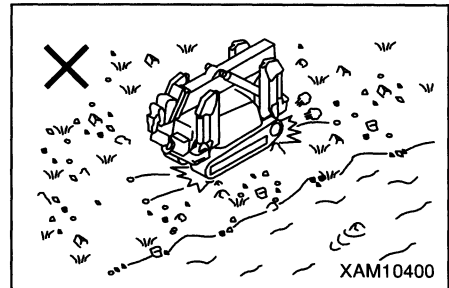
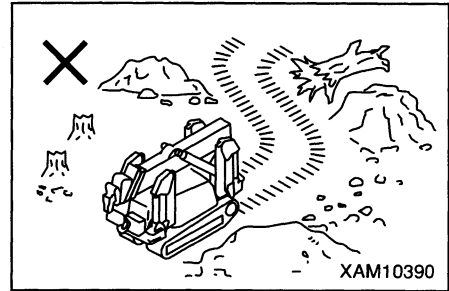



### 3.4 Rule for using it

#### WARNING

Unless following rules for using rubber track are observed, serious accident or damage to the rubber track may result.

Perform your work while observing or paying attention to the following:

- Avoid making spin turn on concrete road surface. Rapidly changing travel direction will result in premature wear or damage of rubber track. Avoid it where possible.
- Do not operate the machine to rub rubber track edge against concrete ridge or wall.
- Avoid changing travel direction where pronounced bump or step exists. For going over bump, go at right angle to it. Going at angle may cause the rubber track to come off.
- Rubber track becomes very slippery on any wet steel plate, snow covered or frozen road surface. Be careful about slipping during travel or work on slope.
- Avoid the use of this machine depending on material to which it is exposed. After inevitable use, wash it clean with water.
  - Working on such material that produces an oily compound when crushed (soybeans, corn, rape cake or the like) should be avoided.
  - Working with salt, ammonium sulfate, potassium chloride, potassium sulfate, double super phosphate of lime, will corrode the adhesion of internal metal.

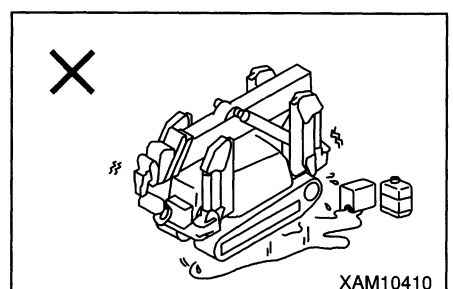
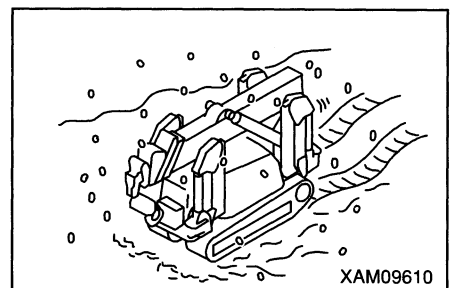
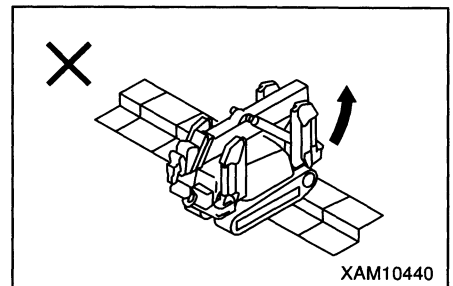
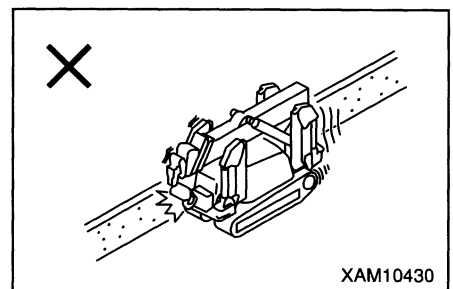
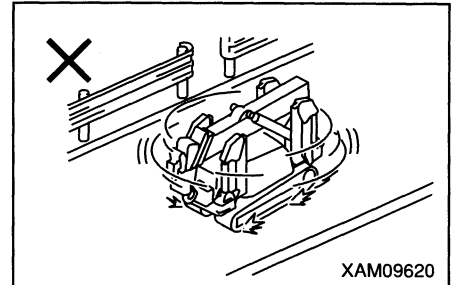

- Avoid use of this machine on beach or the like, because adhesion of internal metal will be corroded by salt.
- Work in extremely cold region causes nature of material of rubber track to change, shortening its service life. Rubber track should be used within the temperature range of  $-25$  to  $+55^{\circ}\text{C}$ , due to nature of rubber.

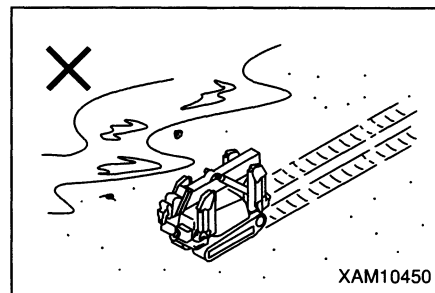

- When handling food products such as salt, sugar, wheat or soy beans, if deep scar exists on rubber track, broken pieces of wire or rubber may enter. Correct any damaged rubber portion before use.

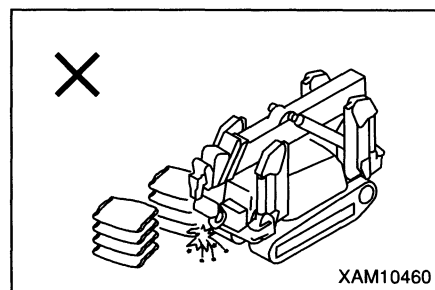

- In order to prevent rubber track from coming off, always keep appropriate tension. Slack in the track may be a cause for its coming off.

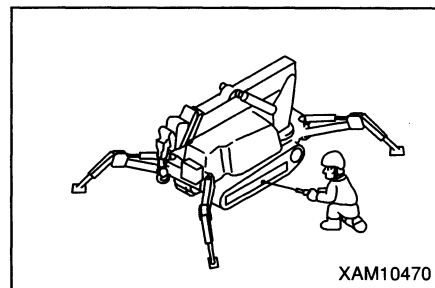

## 4. Handling of Wire Rope

### 4.1 Standard for wire rope replacement

#### CAUTION

- Standard for wire rope replacement is to be regarded common for all the ropes including those for winch, boom telescoping and wiring a load.
- Diameter of wire rope should be measured at the point where it passes sheave repeatedly and its mean value should be taken after measuring it from 3 directions.
- Even if it may have been out of service, old rope should not be used.
- For wire rope replacing procedure, see “MAINTENANCE, 8.4 [6] Replacing the winch wire rope”.
- For replacement or repair of wire rope, contact your dealer.

#### [1] Nominal dimensions of wire rope

- Wire rope for winch: IWRC 6 × Fi (29) 0/0  $\phi 7 \times 46\text{m}$
- Wire rope for extending No.4 boom: IWRC 6 × Fi (29) 0/0  $\phi 9 \times 4.92\text{m}$
- Wire rope for retracting No.4 boom: IWRC 6 × Fi (29) 0/0  $\phi 8 \times 8.28\text{m}$
- Wire rope for extending No.5 boom: IWRC 6 × Fi (29) 0/0  $\phi 6 \times 4.655\text{m}$
- Wire rope for retracting No.5 boom: FC 6 × 37 0/0  $\phi 5 \times 7.85\text{m}$

#### [2] Standard for wire rope replacement

Be sure to observe the ISO4309:1990(E) and the regulations in the area where operations are conducted when replacing wire rope.

## 4.2 Measures to take when winch wire rope is twisted

### CAUTION

Occasionally alternate the take-up of wire rope so that hook block end and winch drum end are exchanged, which will extend its service life.

In case wire rope is twisted, correct it in the following manner:

1. Keeping the hook in normal, check the direction and number of the twist.
2. Push the winch lever forward to Down position and ground the hook block.  
If unable to lower with winch, lower it by pushing the boom hoist lever forward to lower the boom or by pulling back the boom telescoping lever to retract it.
3. Push the main starter switch to Stop position to shutdown the engine.
4. With wedge socket mounting bolt ③ removed, remove the wedge socket ②.
5. Forcibly twist the wire rope end in the opposite direction of hook block being twisted as checked in step 1 above (opposite to the direction to which it automatically tends to return when you take your hand off the wedge socket), by counting "n" times the number the hook block had been twisted, then fix it.
6. Start engine and pull back the boom hoist lever to hoist the boom to the maximum angle.
7. Push the boom telescoping lever forward to extend the boom to the maximum length.
8. Operate the winch lever and repeat hoisting and lowering of the hook block a few times.
9. Take up the wire rope orderly, while keeping tension applied to the rope.
10. Repeat above procedure until the twist is eliminated.

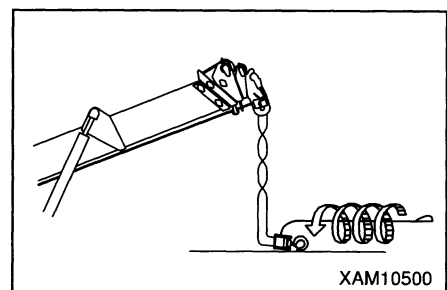
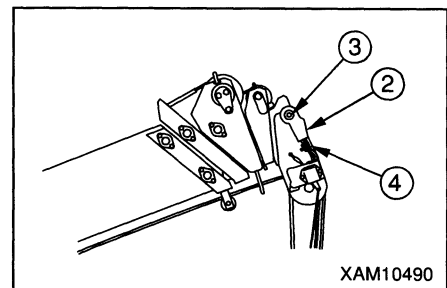
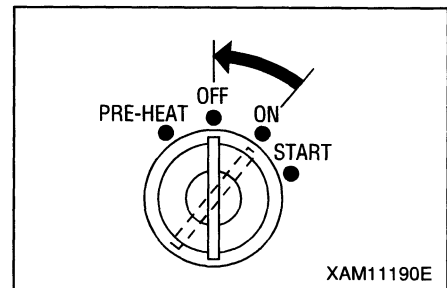
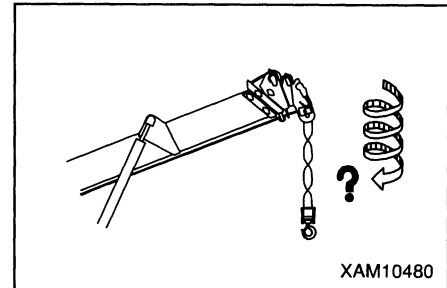

In case the twist can not be removed in spite of above procedure, replace it with new one.

## 5. Transport

For transporting the machine, observe local laws and regulations.

### 5.1 Loading and unloading

#### **⚠ WARNING**

- Ramp board should be used with less than 15 degrees of inclination. Set the distance between the boards to align them to the track gauge of the machine.
- For loading or unloading, let the machine assume Transport Position. See “OPERATION, 2.5 Transport Position of the machine” for detail.
- Loading of the machine should always be carried out with the machine positioned backward. Doing it in forward position may cause tipping over. Further, operator should always take position on the truck bed side.
- Always unload the machine in forward position. Doing it in backward position may cause tipping over. And, operator should always take position on truck bed side.
- Use particular care because the loading and unloading accompanies danger.
- Use the ramp board having sufficient width, length, thickness and strength to enable loading and unloading safely.
- Select level and hard ground and leave sufficient distance from road shoulder.
- Remove mud or dirt off undercarriage to prevent side skidding on ramp board. Also have the ramp board cleaned to remove deposit of grease, oil or ice.
- Never attempt to correct travel direction on ramp board. If you have to, get off the board and correct it.

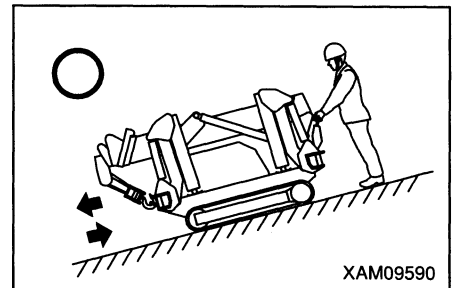

For loading and unloading of the machine, let the machine assume Travel Position and be sure to use ramp board or dispatch platform and follow the instruction below:

1. Engage brake of the truck and apply chocks to tires to prevent the truck from rolling.
2. Lock the ramp board firmly in such a manner as the centers of truck and machine are aligned.

#### **NOTES**

Make sure that height of each board is in equal.

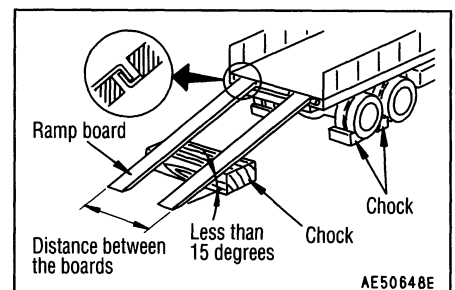

3. Operate acceleration pedal and run the engine at low speed.
4. Travel slowly toward the ramp boards and load or unload using care not have the boom contact the truck. Load in reverse and unload in forward travel.
5. While on ramp board, do not operate any lever other than travel lever.
6. Load the machine at proper location on the truck bed.

## 5.2 How to lift the machine

### **! WARNING**

- Wire rope and hanging device such as shackle should have enough strength for the mass (weight) of the machine.
- For lifting, the machine should assume Travel Position. Location of center of gravity of the machine is designed with the machine in Travel Position. Further, when letting the machine assume Travel Position, increase the tension of the rope to which hook block is to be engaged to prevent the boom derrick cylinder from being extended easily.  
See "OPERATION, 2.5 Travel Position of the machine" for Travel Position.
- Keeping the machine lifted for a long time causes the boom derrick cylinder to extend and center of gravity to shift and as the result the machine may lose balance. Duration of lift should be limited for about 10 minutes.
- When it is necessary to continue to lift the machine for a long time (for more than 10 minutes) or to transport it by means of helicopter, use such transport device as shown to the right for your working safety.
- Do not lift the machine with any other procedure than shown hereunder. It may cause the balance to be lost.



XAM03900

### **CAUTION**

- For operation of crane, official license may be required.
- For the mass (weight) of the machine, see Part V Data and Values
- Data and Values shown there are of standard specifications. Depending on installed attachment or options, proper lifting method may vary. Contact your dealer for detail.

Lift the machine on hard and level ground and in the following procedure:

1. Let the machine assume Travel Position as shown to the right.
2. Either engage hook ② to ① on the boom or use the special hanger ① to engage the hook to it.

**NOTES**

Position ① on the boom represents the center of gravity.

3. Immediately after the machine is lifted off ground, wait for the machine to be stable before continuing to lift slowly.
4. When lifted, make sure that there is no change in machine position due to leakage in hydraulic circuit on the head end of hoist cylinder ③, or there is no play at the hook hanger ④.

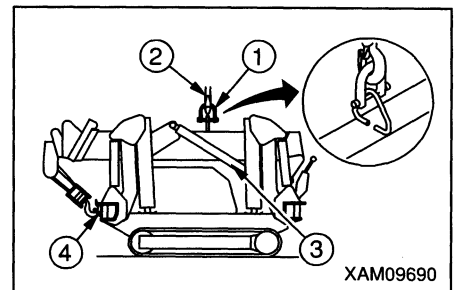
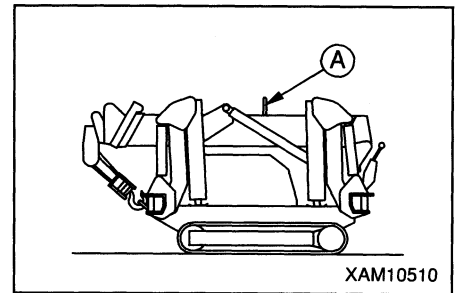

**5.3 Rules for loading**

**⚠ WARNING**

**For loading or unloading of the machine, select level and hard ground.  
Also, have sufficient room from the road shoulder.**

After loading the machine at designated location on truck bed, lock it in the following manner:

1. Stop engine and remove key of main starter switch.
2. So that the machine does not move during transport, engage chocks to front and rear of rubber tracks and lock with chain or wire rope in use. Secure it firmly to prevent side skidding in particular.

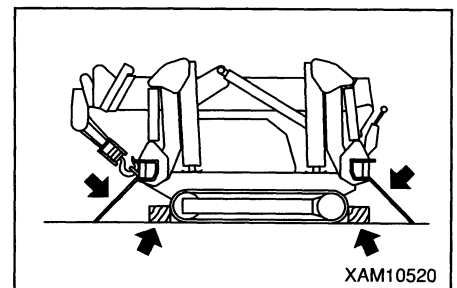

**5.4 Rule for transport**

**⚠ WARNING**

**Determine the route of transport with road width, vertical clearance and mass (weight) taken into consideration.**

For transport, check local laws and regulations on traffic. See sketch to the right for outer dimensions.

## 6. Handling in Cold Climate

### 6.1 Preparation for low ambient temperature

When temperature drops, starting deficiency, frozen coolant or the like develops. Take following measures:

#### [1] Lubricant

Replace lubricant for various components with low viscosity type. For specified viscosity, see Part IV Inspection and Services 5.1 Use of Lubricant in accordance with temperature, for detail.

#### [2] Coolant

### WARNING

**Anti-freeze is inflammable; do not hold a flame near it.  
Do not smoke when handling anti-freeze.**

### CAUTION

**NEVER use methanol, ethanol, or propanol anti-freeze.**

Regarding the replacement frequency of coolant and mixing amount of anti-freeze, see “MAINTENANCE, 8.11 Service in every 1000 hours, [2] Flushing inside of cooling system”.

#### [3] Battery

### WARNING

- **Battery generates inflammable gas which can explode. Do not allow any fire to approach.**
- **Electrolyte is dangerous. Prevent it from getting on your skin or eyes. If it should get on, wash it off with plenty of water and see doctor promptly.**

When temperature drops, so does the battery performance. When charge rate is low, electrolyte may be frozen. Keep the charge rate near 100% where possible and pay attention to insulation to have it ready for work on following day.

### NOTES

For charged rate, measure specific gravity for translation with the chart below:

		Electrolyte temperature (°C)			
		20	0	-10	-20
Charge rate (%)	100	1.28	1.29	1.30	1.31
	90	1.26	1.27	1.28	1.29
	80	1.24	1.25	1.26	1.27
	75	1.23	1.24	1.25	1.26



**[4] Rules for after completion of work**

To prevent deficiency the following morning due to deposit of mud, water or frozen undercarriage, observe following rules:

- Remove mud or water deposited on the machine. Particularly, from hydraulic cylinder surface, dirt may be brought in together with water to damage the sealing.
- Park the machine on dry ground. If such surface is not available, place a plate on ground. It prevents freezing between ground and undercarriage, allowing to start immediately the next morning.
- Remove drain plug off fuel tank to drain residual water in fuel system to prevent freezing.
- Battery performance drops in low temperature. Battery should be covered or stowed in warm area to be re-installed the next morning.
- If electrolyte level is low, replenish with distilled water before starting your work the next morning. In order to prevent freezing during night, do not replenish after work.

**[5] When cold season is over**

With winter gone, when ambient temperature rises, take following measures:

- Replace lubricant of various component with specified type, referring to "MAINTENANCE 5.1 Use of lubricant in accordance with temperature", for detail.
- When using AF-PT anti-freeze (one winter season-only type) due to unavoidable circumstances, completely drain it, flush the inside of coolant system thoroughly, and then, feed city water.

## 7. Long Term Storage

### 7.1 Treatment prior to storage

#### CAUTION

**During long term storage, for protection of cylinder rods, let the machine assume Travel Position. See "OPERATION, 2.5 Travel Position of the machine". (Prevention of corrosion on cylinder rod)**

For long term storage, take following measures:

- Clean every portion before storing it indoors. To leave it outdoors inevitably, select flat area where it is not likely to incur disaster such as flood, and have it covered.
- Be sure to fill with fuel and lubricant and replace oil thoroughly.
- Disconnect negative terminal and cover battery or remove it from the machine and stow it away.
- If the temperature is below 0°C, add the antifreeze to cooling water. See "(2) Cleaning of Inside Cooling System, 8.11 Maintenance per 1000 Hours, Inspection and Maintenance Part", for the ratio of antifreeze.

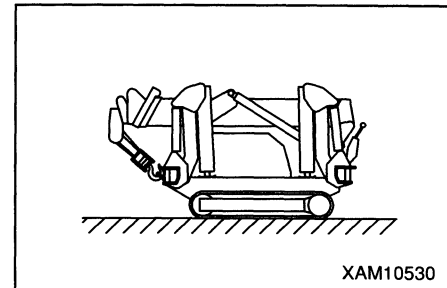

### 7.2 During storage

#### ! WARNING

**To run the machine indoors inevitably for prevention of corrosion, open window or door for improved ventilation to avoid gas intoxication.**

During storage, operate the machine at least monthly to prevent loss of oil film at lubricated area and charge battery as well.

### 7.3 After storage

#### ! WARNING

**If corrosion preventive operation has not been performed during long term storage, contact your dealer before starting to use the machine again.**

Before starting to use your machine after long term storage, take following measures:

- Feed fuel, lubricate and replace oil thoroughly.
- With the cover removed (reinstall if the battery has been demounted from machine), check level and specific gravity of electrolyte before connecting battery cables, starting with positive side.
- Remove drain plugs off fuel tank, hydraulic oil tank and engine oil pan to drain residual water.
- Conduct checks before starting and warm-up run sufficiently while carefully checking various part of the machine.

## 8. Handling of Battery

For handling the battery, observe following rules:

### **! WARNING**

- Inspection or other handling of your battery should be performed with engine shutdown and main starter switch key placed in OFF position.
- Electrolyte generates hydrogen gas which can explode. Do not allow lighted cigarette to approach and avoid any action that may cause spark.
- Electrolyte being dilute sulfuric acid, it damages your clothing or skin. If any of it gets on your clothing or skin, wash it off with plenty of water promptly. If it gets in eyes, immediately wash it out with water and see doctor for treatment.
- For handling battery, wear protective goggles and rubber gloves.
- Disconnect battery cables with the earthing end (normally negative (-) end) first and, to the contrary, connect with positive end (+) first. Touching with tool or the like between negative terminal and positive (+) terminal is dangerous as it generates sparks.
- Loosened terminal may cause sparks to be generated due to deficient contact, resulting in explosion. Be sure to connect terminals securely.
- When replacing, fix it to prevent it from moving. Unless it is locked securely, terminal may be loosened for possible sparking.
- When de-mounting or mounting your battery, make sure of (+) and (-) terminals.

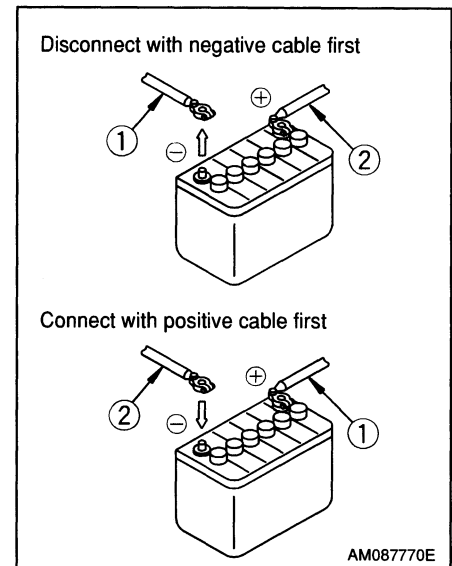

### 8.1 Rules for handling the battery

- Always be alert and do not to allow battery to run down. Rather than charging it in a hurry after having discharged, measure the specific gravity of electrolyte on the earlier side and recharge it as necessary. Maintaining your battery constantly well charged, will extend its service life.
- During hot season, check the electrolyte level more frequently than periodic inspection frequency.
- During cold season, battery capability drops remarkably. Maintain charge rate as close to 100% as possible and pay attention to insulation to make it ready to work in the next morning. Replenishment with distilled water should be carried out prior to starting the work in the next morning, to avoid freezing.

## 8.2 Removal and installation the battery

### CAUTION

After installing your battery, make sure that it does not move. If it does, lock it again.

#### [1] Removal

1. Remove the machinery cover.
  - ★ For the removing procedure, see "OPERATION, 1.5 Machinery Cover".
2. Battery cables should be removed with (-) terminal ①, which is earthing end, first, followed by removal of (+) terminal ②.
3. With wing nut ④ removed, remove battery mounting metalware ③, before removing the battery ⑤.

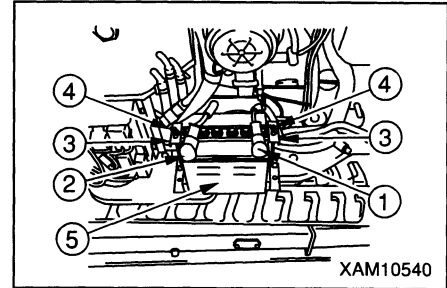

#### [2] Installation

1. Mount the battery with the de-mounting procedure reversed.
2. As for the battery cable, (-) terminal ① which is earthing end should be connected last.

## 8.3 Rules for charging the battery

For charging with the battery as it is mounted:

- As alternator could be damaged with abnormal voltage applied to it, remove wiring for battery terminals before starting to charge.
- During charging, remove all the caps to allow gas to escape.
- In case battery is over-heated (with electrolyte temperature exceeding 45°C), suspend the charging for the time being.
- When charging is complete, discontinue to charge. Continuing to charge after its completion may cause;
  - (1) Over-heating of the battery
  - (2) Reduction of electrolyte volume
  - (3) Battery deficiency
- Do not connect battery cables in opposite (negative and positive). It may cause alternator to be damaged.
- For handling battery for any purpose other than electrolyte level check or its specific gravity measurement, be sure to disconnect battery cables beforehand.

## 8.4 Starting with booster cables in use

For starting your engine with booster cables in use, follow the instruction below:

### [1] Rules for connecting and disconnecting booster cables

#### ⚠ WARNING

- When connecting cables, absolutely do not allow (+) and (-) terminals to contact each other.
- For starting with booster cables in use, wear protector goggles and rubber gloves.
- Do not allow normal and troubled machines to contact each other. Battery generates hydrogen gas and explosion may occur with sparks near the battery.
- Connect booster cables correctly. Final connection generates sparks. Connect it as far away from battery as practicable.
- When disconnecting booster cables, do not allow their clips to contact with each other or with the machine.

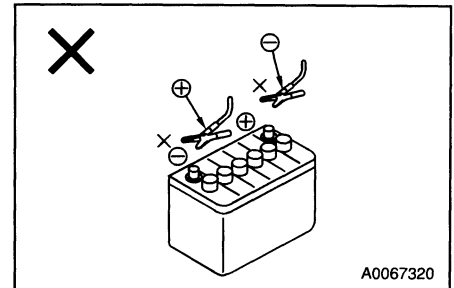

#### CAUTION

- Use booster cable having such clip as the size of which is suitable for the size of battery.
- Battery on the normal machine should be of equal capacity with that on the troubled machine.
- Check the cables and clips for any damage or corrosion.
- Be sure to connect clips firmly.
- Make sure that levers of normal and troubled machine are all in Neutral position.

### [2] Connecting the booster cables

Connect booster cables in accordance with the numbers shown in the diagram to the right.

1. Leave main starter switch on both normal and troubled machines at OFF position.
2. Connect one clip of booster cable (A) to (+) terminal of troubled machine.
3. Connect the other clip of booster (A) to (+) terminal of normal machine.
4. Connect one clip of booster cable (B) to (-) terminal of normal machine.
5. To engine block of troubled machine, connect the other clip of booster cable (B).

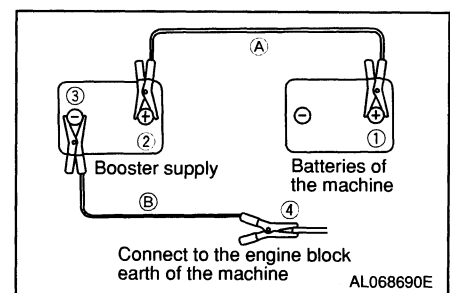

**[3] Starting up the engine****⚠ CAUTION**

**Make sure that levers of normal and troubled machine are all in Neutral position.**

1. Make sure that clips are firmly connected to battery terminals.
2. Start up the engine of normal machine and bring it to maximum rotation.
3. Turn the starter switch key of troubled machine to Start position to start up the engine. If it fails to start, wait for more than 2 minutes before attempting again.
  - ★ For engine starting procedure, see “OPERATION, 2.2 Starting the engine”.

**[4] Disconnecting the booster cables**

Once the engine has started, disconnect them with procedures for starting reversed.

1. Disconnect clip of booster cable (B) which has been connected to engine block of troubled machine.
2. Disconnect clip of booster cable (B) which has been connected to (-) terminal of normal machine.
3. Disconnect clip of booster cable (A) which has been connected to (+) terminal of normal machine.
4. Disconnect clip of booster cable (A) which has been connected to (+) terminal of troubled machine.

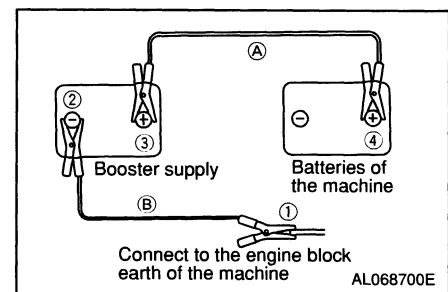

## 9. Measures to be Taken in Case of Abnormality

### 9.1 In connection with electrical components

- For the measures marked with ★ in the Measure column below, contact your dealer.
- In case any abnormality or cause other than shown hereunder is suspected, contact your dealer.

Abnormality	Major cause	Measures to be taken
Light is dull even with engine running at maximum speed	● Defective wiring	★ Check and correct loosened terminal and broken wiring.
Light flickers while engine is running	● Alternator defective ● Wiring defective	★ Replace ★ Check and repair
Charge lamp does not go off even with engine in rotation	● Alternator defective ● Wiring defective	★ Replace ★ Check and repair
Abnormal noise from alternator	● Alternator defective	★ Replace
Starter does not rotate with starter switch turned	● Wiring defective ● Battery charge level low	★ Replace ● Charge
Starter pinion repeats to go in and come out (Whacks)	● Battery charge level deficient.	● Charge
Starter unable to rotate engine fast enough	● Battery charge level deficient. ● Starter defective	● Charge ★ Replace
Before starting engine, starter engagement comes off	● Wiring defective ● Battery charge level deficient.	★ Check and repair ● Charge

### 9.2 In connection with the machine

- For the measures marked with ★ in the Measures column below, contact your dealer.
- In case abnormality or cause other than shown hereunder is suspected, contact your dealer.

Abnormality	Major cause	Measures to be taken
Crane totally unoperable but able to travel	● Crane control valve defective.	★ Check and repair
● Actuation speed slow for travel, boom and hook block ● Abnormal noise generated from around pump.	● Hydraulic oil level low ● Hydraulic oil filter element clogged.	● See "Checks before starting" and replenish with oil ● See Periodical Services and clean or replace
Hydraulic oil temperature rises excessively	● Hydraulic oil level low ● Cooling fins clearances clogged with dust	● See "Checks before starting" and replenish with oil ● Clean
● Rubber crawler come off ● Sprocket wears abnormally	● Rubber crawler tension insufficient	● See Irregular Services and adjust the tension

**9.3 In connection with engine**

- For the measures marked with ★ in Measures column below, contact your dealer.
- In case abnormality or cause other than shown hereunder is suspected, contact your dealer.

Abnormality	Major cause	Measures to be taken
Engine fails to start even starter turned.	<ul style="list-style-type: none"> <li>● Fuel insufficient</li> <li>● Battery charge level low</li> <li>● Compression insufficient</li> </ul>	<ul style="list-style-type: none"> <li>● See “Checks before starting” and replenish with fuel</li> <li>★ Charge battery</li> <li>★ Check and replace.</li> </ul>
Engine starts, but stops immediately	<ul style="list-style-type: none"> <li>● Oil level in oil pan low</li> </ul>	<ul style="list-style-type: none"> <li>● See “Checks before starting” and correct the situation</li> <li>● See cause and measures for Engine does not start</li> </ul>
Engine output insufficient or drops gradually	<ul style="list-style-type: none"> <li>● Air cleaner element clogged</li> <li>● Cooling fin clearance clogged</li> <li>● Compression insufficient</li> </ul>	<ul style="list-style-type: none"> <li>● See Irregular service and clean or replace</li> <li>● Clean</li> <li>★ Check and repair.</li> <li>★ Check and replace.</li> </ul>
Engine water temperature monitor lights up during operation	<ul style="list-style-type: none"> <li>● Lack of coolant</li> <li>● Leak of engine cooling system</li> <li>● Loose fan belt</li> <li>● Clogged radiator fin</li> </ul>	<ul style="list-style-type: none"> <li>● See “Checks before starting” and replenish with coolant.</li> <li>★ Check and repair.</li> <li>● See Periodical Services and check and adjust, or replace belt.</li> <li>● Check and clean</li> </ul>
Engine oil pressure monitor lights up during operation	<ul style="list-style-type: none"> <li>● Lack of engine oil</li> <li>● Clogged engine oil filter</li> <li>● Engine defective</li> </ul>	<ul style="list-style-type: none"> <li>● See Checks before starting and replenish with engine oil</li> <li>● See Periodical Services and check or replace.</li> <li>★ Check and repair.</li> </ul>



## MAINTENANCE

1. Rules for Conducting Service .....	4- 2
2. Basics of Service .....	4- 4
3. Legally Required Inspection .....	4- 6
4. Consumable Parts .....	4- 7
5. Lubrication Oil and Grease .....	4- 8
6. Standard Tools and Standard Tightening Torque .....	4- 9
7. Maintenance Schedule Chart .....	4-12
8. Service Procedure .....	4-14

## 1. Rules for Conducting Service

In order to use this machine safely and without incurring trouble, fully understand the inspection and service items and method thereof described in this manual and perform your inspection and service accordingly.

### WARNING

- **Do not perform any inspection or service other than those described in this manual. Doing it under personal judgment may result in serious accident or trouble. When impossible to judge a level of defect or trouble, contact your dealer for repair.**
- **If any defect or trouble should be found during your use or as a result of inspection, report it to owner or responsible person and contact your dealer for repair.**
- **Inspection and service should be performed with the machine parked on level ground with good foothold.**

#### [1] Checking the hour meter

Everyday, check the hour meter reading and make sure if there is any service item that has reached prescribed servicing interval.

#### [2] Use genuine parts for replacement

Use genuine parts specified by manufacturer for replacement.

#### [3] Use genuine oil and grease for replacement

Use genuine oil and grease. Also, use those having specified viscosity for ambient temperature.

#### [4] Use clean oil and grease

Use clean oil, grease as well as container and prevent dust from entering.

#### [5] Keep the machine clean

For easy detection of deficiency, machine should be kept clean. Particularly, keep grease fittings, breather and oil level gauge (inspection panel) clean and avoid dust from entering.

#### [6] Pay attention to coolant and oil temperature

Coolant and oil draining or filter replacement immediately after stopping work is dangerous. Wait for temperature to drop. When oil is cold, on the contrary, warm it (at about 20 – 40°C) before proceeding with such job.

#### [7] Check the drained oil and filter

After replacing oil and before changing the filter, check the drained oil and filter to see if any metal or foreign matter is visible.

#### [8] Care to be taken about feeding oil

Wherever strainer is provided at filler port, do not feed oil with the strainer removed.

#### [9] Pay attention to dust entering

Check or replace oil in dust-free location and prevent trash from entering.

#### [10] Affix caution plates

When you have drained oil, in order to prevent engine from being started inadvertently by some one, affix a caution plate on travel control panel.

**[11] Observe cautions**

Observe content of caution plates affixed to the machine.

**[12] Care to be taken concerning welding repair work**

- Disconnect power supply (Turn off the main starter switch.)
- Install earthing within one meter of welding location.
- Use care not to allow any seal or bearing to enter between welding location and earthing. Spark may damage sealings.
- Avoid placing earth line near the boom pin or hydraulic cylinder. Spark may damage plated area.

**[13] Pay attention to fire**

Clean the parts, using non-inflammable cleanser or light oil. When using light oil, do not allow any fire to approach.

**[14] Keep mating surfaces clean**

When you disassembled where seal such as O-ring or gasket has been used, clean the mating surfaces and replace the seal with new one. Do not forget to install new O-ring or gasket.

**[15] Do not drop anything from your pockets**

For working while bending down with a cover opened, remove anything from your cloth pocket so you do not drop it through the opening.

**[16] Check the undercarriage**

When working on rocky surface, check for damage of undercarriage and loosened, cracked, worn or damaged bolt and nut and use the rubber track with less tension than normal.

**[17] Checking at the time of cleaning**

- Do not apply spray of mist to electric components and connector directly.
- Do not water control panels.
- Do not apply pressurized water directly to the recoil starter
- For cleaning, while watering continually, wash down any dirt or dust using clean waste cloth or the like.

**[18] Verification and inspection before and after operation**

In case of work in mud water, rain, snow or on the beach, before starting, check plugs and valves for tightness and after work clean the machine and check for crack, damage, loosened or missing bolt and nut. Lubrication should be performed on the earlier side. Particularly, pins of the machine which are immersed in mud water should be lubricated every day.

**[19] In dusty area**

For working in dusty area, following care should be taken:

- Check air cleaner more frequently for clogging.
- Recoil starter should be cleaned on the earlier side to avoid clogging.
- Clean and replace fuel filter on the earlier side.
- Clean electric components, starter and alternator in particular, to avoid accumulation of dust.

**[20] Do not mix oil**

Using different brands and types of oil in mix should definitely be avoided. When replacing, replace them totally. Use genuine parts for replacement.

## 2. Basics of Service

### [1] Handling of oil

- Oil being used under extremely severe conditions (high temperature and high pressure) by engine and attachment, its deterioration progresses along with operating time. Be sure to use oil that meets such grade and temperature as described in the manual. Even if the oil is not dirty yet, be sure to replace at designated interval anyway.
- Oil corresponds to blood in human body. Use sufficient care to prevent impurity (water, metal powder, trash, etc.) from entering. Majority of machine trouble is attributable to entering of foreign matter. Be extra careful about impurity particularly during storage or at the occasion of refueling.
- Do not mix with any oil of different grade or brand.
- Fill oil to the specified level only. Either excessive or insufficient oil can be a cause for trouble.
- When oil for attachment becomes cloudy, entry of water or air into circuit is conceivable. Contact your dealer for remedy.
- When you replace oil, replace filter as well.
- At the time of factory shipment, ISO VG32 is in use for hydraulic system.  
Do not use any hydraulic oil not recommended by the manufacturer as it will cause clogging of filter. Mixing only small amount of oil remaining in piping and cylinder with other brand at the time of replacement will not really present a problem.

### [2] Handling of fuel

- Fuel pump is a precision instrument which becomes inoperative if you use fuel containing water or trash. Use special care not to allow impurity to be mixed when storing or filling it.
- At the replenishment of fuel, do not remove the strainer at the filler port.
- Be sure to use fuel which fits grade and working temperature specified in the instruction manual.
- To prevent air containing humidity in the fuel tank from condensing and being mixed to the fuel, fill up the tank after everyday work.
- Before starting the engine or approximately 10 minutes after the replenishment of fuel, drain sediment and water from the fuel tank.
- If the machine runs out of fuel or fuel filter is replaced, it is necessary to bleed the circuit.
- If a foreign matter enters the fuel tank, clean the tank and fuel system.

### [3] Storage of oil.

- Store oil indoors while using care not to allow impurity to be mixed such as water or trash.
- For long term storage in oil drum, place drums horizontally so that their openings are aligned laterally in line (for preventing suction of humidity). If you have to store outdoors, use care such as by covering them with waterproof sheet.
- In order to avoid change in quality, use them in the order in which they have been placed in stock.

### [4] Handling of grease

- Grease prevents development of galling and noise at joint.
- Any nipple not listed in Part V Periodical Service being only for the service and adjustment purpose, does not need greasing. If friction develops after long time of use, apply grease.
- Wipe off old grease clean as it is forced out after greasing. In such area where sand or dust is likely to get on to accelerate wear of rotational part, old grease must be wiped off with particular care.

**[5] Handling of filter**

- Filter is an extremely important part of the system as it prevents foreign matter contained in oil, fuel or air circuit from entering essential system to cause trouble. Replace them periodically in accordance with instruction manual. In case of severe working circumstances or depending on type of oil, there are cases where replacement must take place with shorter interval.
- Never re-use any filter (cartridge type) even after cleaning it.
- When you replaced oil filter, check the used filter for deposit of metal powder or the like. If it is, contact your dealer.
- Package of replacement filter should not be opened until immediate before its use.
- Be sure to use genuine filter only.

**[6] Handling of coolant**

- River water contains a lot of calcium and impurity. If you use it, fur deposits in the engine and radiator to cause defective heat exchange and overheat.  
Do not use water which does not fit for drinking.
- When using anti-freeze, observe precautions in the instruction manual.
- Anti-freeze is inflammable. Specially be careful with fire.
- Anti-freeze mixing ratio differs depending on outdoor temperature.  
Regarding the mixing ratio, see "MAINTENANCE, 8.11 Service in every 1000 hours, [2] Flushing inside of cooling system".
- If the engine overheats, wait until it cools down and add coolant.
- Insufficient coolant causes overheat and corrosion due to mixing of air.

**[7] Handling electrical components and parts**

- When it gets wet or its cover is broken, electrical component or parts is very dangerous because, due to resultant power leakage, the machine may go out of order or malfunction.
- Inspection and service includes the check of belt for proper tension or damage, and that of electrolyte level.
- Do not remove or disassemble any electric component mounted to the machine.
- Do not install any electric component other than those provided as optional.
- Do not allow any electric component to get wet when washing the machine, or in the rain.
- For working on the beach, intensify the service on electrical components to avoid corrosion.

**[8] Handling of hydraulic system**

- Hydraulic system is heated during or immediately after work. During work, high pressure is applied to it as well. For inspection and service on hydraulic system, use care such as follows:
- Select level ground and let the machine assume Travel Position so that pressure is not applied to cylinder circuit.
- Be sure to shutdown the engine.
- Immediately after operation, temperature and pressure of hydraulic oil and lubrication oil are high. Wait for the oil temperature to drop before starting your service work. Even if temperature has dropped, be careful as there are cases where internal pressure remains. When loosening plug, screw or hose joint, avoid positioning yourself directly in front, and remove them by loosening slowly and gradually while letting the internal pressure to escape.
- For inspection and service of hydraulic system, be sure to bleed hydraulic oil tank and eliminate internal pressure.
- Inspection and service includes hydraulic oil level check, filter replacement and hydraulic oil replacement.
- When you remove high pressure hose or hydraulic piping, check O-ring for any scar or damage and replace as necessary.
- When you have replaced or cleaned the hydraulic oil filter element and strainer, or repaired or replaced the hydraulic equipment, or removed hydraulic piping, it is necessary to bleed the circuit internals.

### **3. Legally Required Inspection**

#### **3.1 Safety regulation on crane**

Check you local authority for the legal requirement. Generally however, following procedure is required for the purpose of such inspection:

1. Check safety systems for proper function.
2. Check hanging devices such as hook block for any abnormality.
3. Check winch wire rope end and wire clip for any damage.
4. f any defect is found on wire rope, replace it promptly.
5. Check hydraulic hose for leakage or surface damage due to friction. If any damage is found on surface, replace the hose.
6. Check structural part of boom for any crack or deformation.
7. Check for loosened or missing mounting bolts and joints.
8. Check boom extension, hoist and swing motions for proper actuation and stopping.

With inspection performed, if any deficiency should be found, contact your dealer.

## 4. Consumable Parts

Consumable parts including filter element and wire rope should be replaced at the time of periodical service or before their wearing limit. Use this machine economically by replacing consumable parts punctually. Use only genuine parts for replacement purpose. For ordering, refer to part numbers listed in parts catalog.

### List of consumable parts

Item	Hours for replacement
Hydraulic oil return filter	Every 500 hours
Cylinder packing	★ Every 3 years
Boom sliding plate	Every 3 years
Winch wire rope	★ Every 3 years
Boom extending wire rope	★ Every 3 years
Boom retracting wire rope	★ Every 3 years

- ★ Hours for replacement with ★ mark includes idle hours of machine.
- ★ For replacement of parts, contact your dealer.

## 5. Lubrication Oil and Grease

### 5.1 Applicable lubricants by ambient temperature

In accordance with ambient temperature, use lubricant in the following manner:

Lubricating place	Type of oil	Use by temperature (°C)									Specified capacity (ℓ)	Volume to replace (ℓ)
		-30	-20	-10	0	10	20	30	40	50		
Engine oil pan	Engine oil										Hi: 2.3 Lo: 1.0	Hi: 2.3 Lo: 1.0
		SAE30WCD										
		SAE10WCD										
		SAE10W-30CD										
		SAE15W-40CD										
Hydraulic oil tank	Wear resistant Hydraulic oil										20	20
		ISO VG22										
		ISO VG32										
		ISO VG46										
Swing machinery case	Gear oil										0.6	0.6
Winch reduction gear case		ISO VG320								0.5	0.5	
Travel motor reduction gear case											0.33	0.33
Fuel tank	Diesel fuel										12	—
		ASTM D975 No.2										
		ASTM D975 No.1										
Cooling system	Water	Add antifreeze								2.1	2.1	

- “Specified oil capacity” means total capacity including the oil which fills piping for various systems, while “Volume to replace” represents volume of oil required for replacement at the time of inspection and service.
- For starting up engine at ambient temperature below 0°C, even if it is known that temperature during day rises to about 10°C, still be sure to use SAE10W-CD, SAE10W-30CD, SAE15W-40CD.
- For the wear resistant hydraulic oil for hydraulic systems (ISO VG46, VG32 and VG22), use the oil we recommend. When shipped out of our factory Super Highland 32 is in use.

When ambient temperature drops below -10°C, adjust concentration in accordance with 8.4 Irregular Service, Cleaning the cooling system internals.

ASTM: American Society of Testing and Material

SAE: Society of Automotive Engineers



## 6. Standard Tools and Standard Tightening Torque

### 6.1 Inquiry on standard tools

No.	Tool	Remarks
1	Wrench	Applicable width across flats (S1-S2): 10 – 12mm
2		
3	Handle for box wrench	

If any of above tools should fail, order the replacement with your dealer.  
If you need any tool for your inspection and service work, contact your dealer.

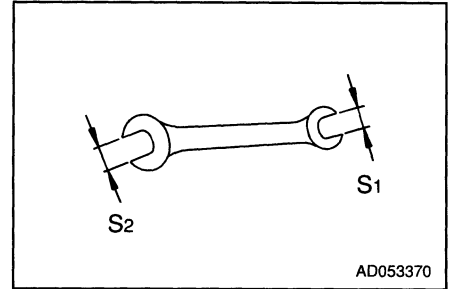

### 6.2 List of standard tightening torque

Tighten metric threaded bolts and nuts with torque shown below, unless specifically indicated. Determine appropriate tightening torque according to width across flats (b) of bolts and nuts.

#### [1] Bolt marked [8.8] (strength classification) at its head

Nominal a (mm)	Width across flats b (mm)	Tightening torque {N·m (kgf·m)}	
		Target value	Allowance
6	10	7.8 (0.80)	6.8 – 9.0 (0.70 – 0.92)
8	13	19.0 (1.95)	16.5 – 21.9 (1.70 – 2.24)
10	17	37.5 (3.85)	32.6 – 43.1 (3.35 – 4.43)
12	19	65.5 (6.70)	57.0 – 75.3 (5.85 – 7.70)
14	22	104 (10.6)	90.4 – 120 (9.2 – 12.2)
16	24	163 (16.6)	142 – 187 (14.4 – 19.1)
18	27	224 (22.8)	195 – 258 (19.8 – 26.2)
20	30	318 (32.4)	277 – 366 (28.2 – 37.3)
22	32	432 (44.0)	376 – 497 (38.3 – 50.6)
24	36	549 (56.0)	477 – 631 (48.7 – 64.4)
27	41	804 (81.9)	699 – 925 (71.2 – 94.2)
30	46	1,090 (111)	948 – 1,250 (96.5 – 128)
33	50	1,485 (151)	1,290 – 1,710 (131 – 174)
36	55	1,910 (194)	1,660 – 2,200 (167 – 223)

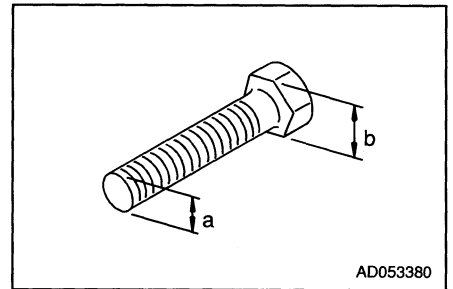

**[2] Bolt marked [10.9] (strength classification) on its head:**

Nominal a (mm)	Width across flats b (mm)	Tightening torque {N·m (kgf·m)}	
		Target value	Allowance
6	10	11.0 (1.1)	9.4 – 12.7 (0.93 – 1.26)
8	13	27.0 (2.7)	23.0 – 31.1 (2.3 – 3.10)
10	17	53.0 (5.4)	45.0 – 61.0 (4.6 – 6.21)
12	19	93.0 (9.5)	79.0 – 107 (8.10 – 10.9)
14	22	148 (15.1)	126 – 170 (12.8 – 17.4)
16	24	231 (23.5)	196 – 266 (20.0 – 27.0)
18	27	317 (32.3)	269 – 365 (27.5 – 37.1)
20	30	450 (45.9)	383 – 518 (39.0 – 52.8)
22	32	612 (62.4)	520 – 704 (53.0 – 71.8)
24	36	778 (79.3)	661 – 895 (67.4 – 91.2)
27	41	1,130 (116)	961 – 1,300 (98.6 – 133)
30	46	1,540 (158)	1,310 – 1,770 (134 – 182)
33	50	2,100 (214)	1,790 – 2,410 (182 – 246)
36	55	2,700 (275)	2,300 – 3,100 (234 – 316)

**[3] Bolt marked [12.9] (strength classification) on its head:**

Nominal a (mm)	Width across flats b (mm)	Tightening torque {N·m (kgf·m)}	
		Target value	Allowance
6	10	13.0 (1.30)	11.1 – 15.0 (1.11 – 1.50)
8	13	31.5 (3.20)	26.8 – 36.2 (2.72 – 3.70)
10	17	62.5 (6.40)	53.1 – 71.9 (5.44 – 7.35)
12	19	109 (11.1)	92.7 – 125 (9.44 – 12.8)
14	22	174 (17.7)	148 – 200 (15.0 – 20.4)
16	24	271 (27.7)	230 – 312 (23.5 – 31.9)
18	27	373 (38.1)	317 – 429 (32.4 – 43.8)
20	30	529 (54.0)	450 – 608 (45.9 – 62.1)
22	32	720 (73.4)	612 – 828 (62.4 – 84.4)
24	36	915 (93.3)	778 – 1,050 (79.3 – 107)
27	41	1,340 (136)	1,140 – 1,540 (116 – 156)
30	46	1,820 (185)	1,550 – 2,090 (157 – 213)
33	50	2,470 (252)	2,100 – 2,840 (214 – 290)
36	55	3,180 (324)	2,700 – 3,660 (275 – 373)

**[4] Other bolts**

Nominal a (mm)	Width across flats b (mm)	Tightening torque {N·m (kgf·m)}	
		Target value	Allowance
6	10	3.0 (0.30)	2.6 – 3.5 (0.26 – 0.35)
8	13	7.5 (0.75)	6.5 – 8.6 (0.65 – 0.85)
10	17	14.5 (1.45)	12.6 – 16.7 (1.25 – 1.65)
12	19	25.0 (2.55)	21.7 – 28.8 (2.20 – 2.95)
14	22	40.0 (4.10)	34.8 – 46.0 (3.55 – 4.70)
16	24	62.5 (6.40)	54.3 – 71.9 (5.55 – 7.35)
18	27	86.0 (8.75)	74.8 – 98.9 (7.60 – 10.0)
20	30	122 (12.4)	106 – 140 (10.8 – 14.3)
22	32	166 (16.9)	144 – 191 (14.7 – 19.4)
24	36	211 (21.5)	183 – 243 (18.7 – 24.7)
27	41	309 (31.4)	269 – 355 (27.3 – 36.1)
30	46	419 (42.6)	364 – 482 (37.0 – 49.0)
33	50	570 (58.0)	495 – 656 (50.4 – 66.7)
36	55	732 (74.5)	636 – 842 (64.8 – 85.7)

## 7. Maintenance Schedule Chart

Maintenance item	Page
<b>8.1 Initial 10 hours service (Only after the first 10 hours.)</b>	4 - 14
[1] Grease all parts of machine	4 - 42
<b>8.2 Initial 50 hours service (Only after the first 50 hours.)</b>	4 - 14
[1] Change oil in hydraulic tank	4 - 57
[2] Replace hydraulic oil return filter	4 - 51
<b>8.3 Initial 250 hours service (Only after the first 250 hours.)</b>	4 - 14
[1] Change engine oil and replace filter cartridge	4 - 48
[2] Replace fuel filter	4 - 50
[3] Check and adjust engine valve clearance	4 - 63
[4] Change oil in swing machinery case	4 - 59
[5] Change oil in winch reduction gear case	4 - 60
[6] Change oil in travel motor reduction gear case	4 - 62
<b>8.4 When required</b>	4 - 15
[1] Replace rubber crawler	4 - 15
[2] Replace winch wire rope	4 - 17
<b>8.5 Checks before starting</b>	4 - 21
[1] Check coolant level, and add water	4 - 21
[2] Check radiator fin, and clean it	4 - 22
[3] Check engine oil level in engine, and add oil	4 - 23
[4] Check fuel level in fuel tank, and add fuel	4 - 24
[5] Check water separator, and clean it	4 - 25
[6] Check fuel filter	4 - 26
[7] Check oil level in hydraulic tank, and add oil	4 - 27
[8] Check oil level in swing machinery case, and add oil.	4 - 28
[9] Check and adjust rubber crawler tension	4 - 29
[10] Check damage and wear for rubber crawler	4 - 32
[11] Check electrolyte level	4 - 33
[12] Check over-hoist alarm system	4 - 34
[13] Check horn	4 - 34
[14] Check working light	4 - 35
[15] Check electric wiring	4 - 35
[16] Check crack, deformation or damage of boom and frame	4 - 35
[17] Check deformation, damage or wear of wire rope	4 - 35
[18] Check and adjust boom telescope wire rope	4 - 36
[19] Check winch and boom movement	4 - 39
<b>8.6 Every 30 hours service</b>	4 - 40
[1] Check air cleaner, and clean it	4 - 40

Maintenance item	Page
<b>8.7 Every 50 hours service</b>	4 – 42
[1] Grease all parts of machine	4 – 42
[2] Drain water, sediment from fuel tank	4 – 44
<b>8.8 Every 100 hours service</b>	4 – 45
[1] Check oil level in winch reduction gear case, and add oil	4 – 45
<b>8.9 Every 250 hours service</b>	4 – 46
[1] Check and adjust alternator belt tension	4 – 46
[2] Check oil level in travel motor reduction gear case, and add oil	4 – 47
<b>8.10 Every 500 hours service</b>	4 – 48
[1] Change engine oil and replace filter cartridge	4 – 48
[2] Replace fuel filter	4 – 50
[3] Replace hydraulic oil return filter and suction filter	4 – 51
<b>8.11 Every 1000 hours service</b>	4 – 53
[1] Replace air cleaner	4 – 53
[2] Clean inside cooling system	4 – 54
[3] Change oil in hydraulic tank	4 – 57
[4] Change oil in swing machinery case	4 – 59
[5] Change oil in winch reduction gear case	4 – 60
[6] Change oil in travel motor reduction gear case	4 – 62
<b>8.12 Every 2000 hours service</b>	4 – 63
[1] Check and adjust engine valve clearance	4 – 63
[2] Check alternator and starter	4 – 63

## **8. Service Procedure**

### **8.1 Initial 10 hours service**

Carry out the following maintenance after the initial 10 hours breaking-in operation for new machine.

#### **[1] Grease all parts of machine**

For details of the method of maintenance, see "MAINTENANCE, 8.7 every 50 hours service".

### **8.2 Initial 50 hours service**

Carry out the following maintenance after the initial 50 hours breaking-in operation for new machine.

#### **[1] Change oil in hydraulic tank**

For details of the method of maintenance, see "MAINTENANCE, 8.11 every 1000 hours service".

#### **[2] Replace hydraulic oil return filter**

For details of the method of maintenance, see "MAINTENANCE, 8.10 every 500 hours service".

### **8.3 Initial 250 hours service**

Carry out the following maintenance after the initial 250 hours breaking-in operation for new machine.

#### **[1] Change engine oil and replace filter cartridge**

For details of the method of maintenance, see "MAINTENANCE, 8.11 every 1000 hours service".

#### **[2] Replace fuel filter**

For details of the method of maintenance, see "MAINTENANCE, 8.10 every 500 hours service".

#### **[3] Check and adjust engine valve clearance**

For details of the method of maintenance, see "MAINTENANCE, 8.12 every 2000 hours service".

#### **[4] Change oil in swing machinery case**

For details of the method of maintenance, see "MAINTENANCE, 8.11 every 1000 hours service".

#### **[5] Change oil in winch reduction gear case**

For details of the method of maintenance, see "MAINTENANCE, 8.11 every 1000 hours service".

#### **[6] Change oil in travel motor reduction gear case**

For details of the method of maintenance, see "MAINTENANCE, 8.11 every 1000 hours service".

### 8.4 When required

#### [1] Replace rubber crawler

#### **⚠ WARNING**

- Grease is packed inside the rubber crawler tension adjust system, and such grease is at high pressure due to tension of the crawler. By making adjustment without observing following instruction, grease valve may spring out, to cause serious accident.
- Tension adjustment grease valve should not turned out by more than one turn. It may cause grease valve to spring out.
- To make tension adjustment, do not position yourself in front of the grease valve to avoid possible risk.
- Before disengaging rubber crawler, make sure that internal grease has been completely removed, then rotate the sprocket.

#### [Removal rubber crawler]

- ★ Have a piece of steel pipe ready.
1. Set up outrigger and lift the undercarriage by about 80mm.
    - ★ For the outrigger setting up method, see “OPERATION, 2.12 Setting up the outrigger”.
  2. With 2 mounting bolts ② removed, remove the inspection cover ①.
  3. Loosen the grease valve ③ gradually to let grease come out.
  4. The grease valve ③ should never be turned out by any more than one turn at the maximum.
  5. Insert the steel pipe between idler and rubber crawler as shown in sketch and rotate the sprocket in the direction of reverse travel.
  6. When the rubber crawler is lifted with the steel pipe, slide it laterally to remove.

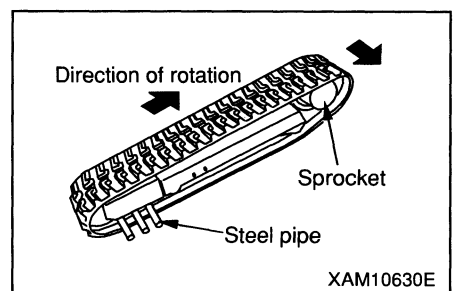
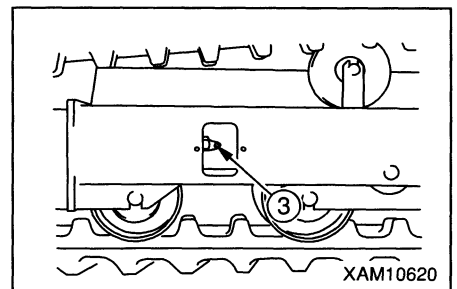
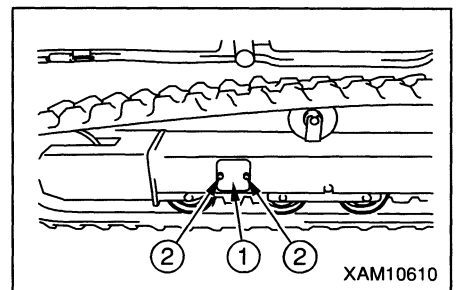

**[Installation rubber crawler]**

- ★ Have a grease gun ready.
- ★ Have a piece of steel pipe ready.

1. Set up outrigger and lift the undercarriage off the ground by about 80mm.
  - ★ For the outrigger setting up method, see “OPERATION, 2.12 Setting up the outrigger”.

2. Mesh the rubber crawler with sprocket and have it engaged with idler.
3. With the sprocket rotating in the rear traveling direction, thrust in the rubber crawler and stop the rotation of sprocket.

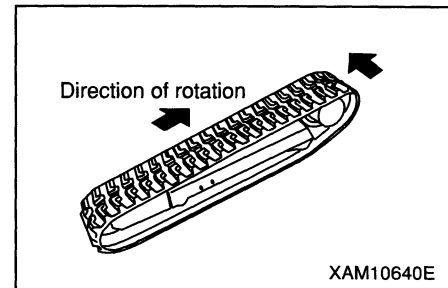

4. After inserting the steel pipe, rotate the sprocket again and engage the rubber crawler with the idler securely.

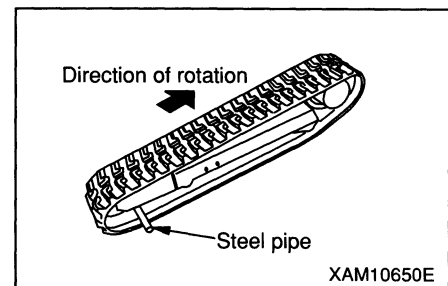

5. Stop the rotation and make sure that the rubber crawler is engaged with sprocket and idler securely.

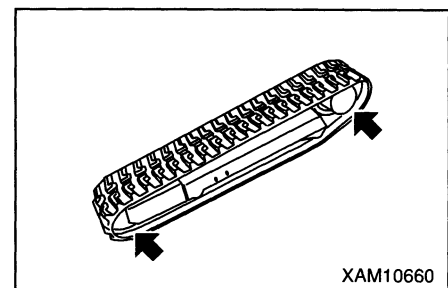

6. Adjust the rubber crawler tension..
  - ★ See [3] Check and adjust the rubber crawler tension.
7. Make sure that engagement of rubber crawler with sprocket and idler and track tension are satisfactory.
8. Stow away outrigger and lower the machine to ground.
  - ★ For the outrigger stowing method, see “OPERATION, 2.23 Stowing the outrigger”.



**[2] Replace winch wire rope**** WARNING**

For replacing the wire rope, be sure to wear heavy working gloves.

**CAUTION**

- Diameter of wire rope should be measured at its portion that goes over sheave repeatedly and mean value of measurements taken from 3 directions should be adopted.
- Even if it has not been in use, any wire rope that has become aged should not be used.

**[Standard for wire rope replacement]**

Be sure to observe the ISO4309:1990(E) and the regulations in the area where operations are conducted when replacing wire rope.

**[Removal wire rope]**

Remove wire rope in the following procedure:

1. Place the machine on level, hard ground.
2. Push the boom telescoping lever forward to Extend position and extend the boom slightly.
3. Push the winch lever forward to Down position to ground the hook block.
4. After removing wedge socket mounting bolt ②, remove the wedge socket ③.
5. Remove wire clip ④.

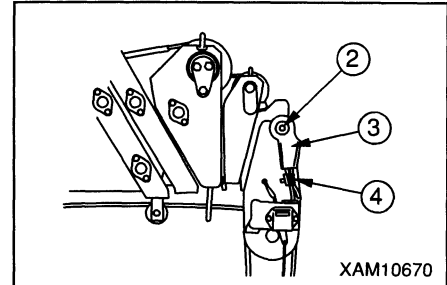

6. Remove wire rope ⑤ from wedge socket ③ in the following procedure:
  - (1) Have a piece of round bar ⑥ having diameter of 4 – 6mm ready and apply it to rope wedge ⑦.
  - (2) Lightly tap round bar ⑥ with hammer in the direction of arrow ① to remove the rope wedge ⑦.

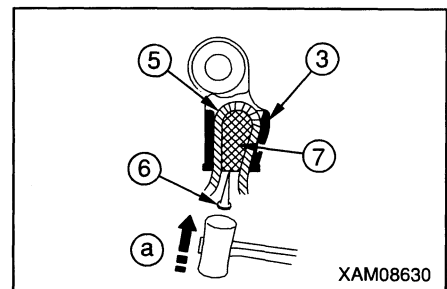

7. Push the winch lever forward to Down position and take off the wire rope ⑤ from winch drum.

8. When you have taken off the wire rope, remove the end of wire rope ⑤ which has been attached to winch drum ⑧, in the following procedure:

- (1) Have a piece of round bar ⑥ with diameter of 4 – 6mm ready and apply it to rope wedge ⑨.
- (2) Lightly tap round bar ⑥ with hammer in the direction of arrow ② to remove the rope wedge ⑨.

9. Take off the remaining wire rope ⑤ completely.

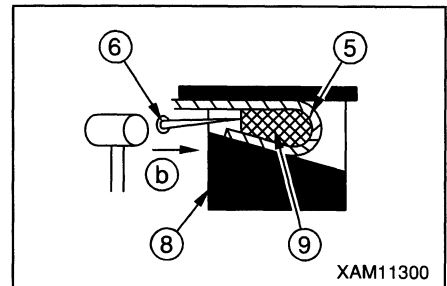

That completes the removal of wire rope.

[Installation wire rope]

**! WARNING**

Rope wedge for attaching the wire rope should be installed correctly and firmly. Otherwise, there is a risk of wire rope coming off during crane work, resulting in serious accident.

**CAUTION**

- When taking up wire rope, use care to prevent it from being taken up disorderly on the drum.
- Immediately after installing new wire rope, lift a load (300 – 500kg) with boom extended and hoisted to maximum and repeat hoisting and lowering of hook block a few times for breaking-in the rope.
- Wire rope has been wound in coil. When taking it up, use care not to cause kinks. When taking the rope off the drum, be sure to have the rope itself rotate while unwinding.

Install wire rope in the following procedure:

1. Holding the wire rope by its end, thread the wire rope ⑤ through the weight of over-hoisting, load sheave ① at boom top end, wire guard ② at No.3 boom, guide sheave ③ at No.1 boom and idler sheave ④ at No.1 boom.
2. Thread the wire rope ⑤ through rope installation hole of winch drum ⑧ and attach it to the winch drum in the following procedure:
  - (1) Thread the wire rope ⑤, as it is slackened, through the winch drum ⑧.
  - (2) Place the rope wedge ⑨ in position ②, engage the wire rope ⑤ to the wedge ⑨ and pull it hard in the direction of arrow. To prevent the end of wire rope ⑤ from protruding at the narrow side of the hole of winch drum ⑧, adjust the length of wire rope.
3. Pull back the winch lever slowly to Up position and take up the wire rope ⑤ onto the winch drum ⑧.

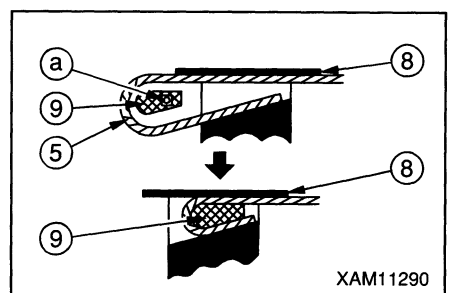
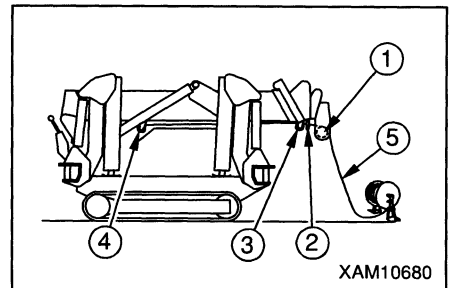

4. In accordance with the number of part-reeving (4, in this case), thread the wire rope through the boom end load sheave, hook block sheave, boom end wire guide, and weight for over-hoisting as shown to the right.

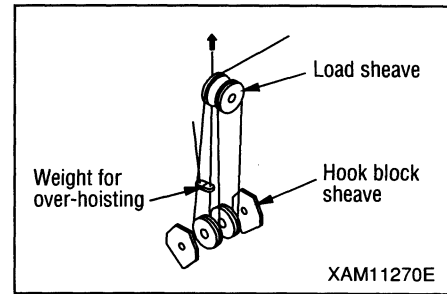

5. As shown to the right, thread the wire rope ⑤ through the fixed sheaves ⑩ and ⑪ at the end of boom No. 5.

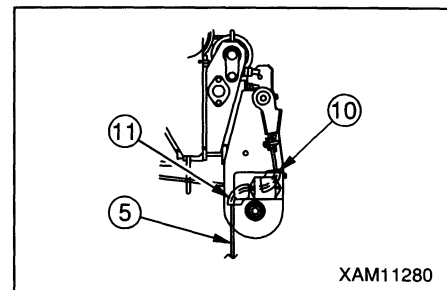

6. In the following procedure, attach the end of wire rope ⑤ to the wire socket ③.

- (1) Thread the wire rope ⑤ to wedge socket ③ as shown in the drawing.
- (2) Place rope edge ⑦ into position ② before pulling wire rope ⑤ hard in the direction of arrow.

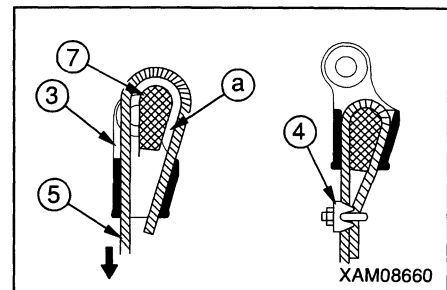

7. Install wire clip ④ to the wire rope ⑤.

8. Install wedge socket ③ to boom and tighten.

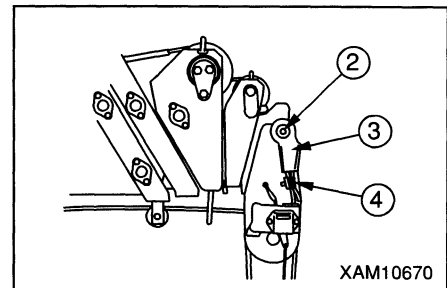

9. Pull back the boom hoisting lever to Hoist position or push down the boom extension lever toward you to Extend position to lift the hook block.

**NOTES**

Do not operate the winch until the hook block is lifted.

10. Place the boom in full extension and full hoisting, push the winch lever forward to Lower position so that a few windings of wire rope ⑤ remain on the winch drum ⑧.

11. With tension being applied to wire rope ⑤, pull back the winch lever to Up position to take up the wire rope ⑤ on the winch drum ⑧.

### 8.5 Checks before starting

Perform steps in this section before the first start of engine of the day.

#### [1] Check coolant level, and add water

#### **⚠ WARNING**

- **When checking coolant level and adding water, radiator cap must be always on. Be sure to perform checking at reservoir tank.**  
**High temperature coolant may gush out, causing you to get a burn.**
- **Cooling water should not be supplied from the upper part of the radiator. However if there is no other choice but to do it, check if the engine and surrounding parts are cool enough before doing it.**

1. Park the machine on level land.
2. Check the coolant level of reservoir tank ① is at midpoint between LOW and FULL through the inspection window A at the front right side of machinery cover.
3. When it is below LOW, add city water following the procedures below.
  - (1) Referring to “OPERATION, 1.5 Machinery cover”, remove the machinery cover.
  - (2) Remove the cap of reservoir tank ① and add water up to the FULL level through the water filler.
  - (3) After the replenishment of coolant, securely mount the cap ② of reservoir tank ①.
  - (4) Referring to “OPERATION, 1.5 Machinery cover”, mount the machinery cover.
4. When the reservoir tank is empty, take the following procedures.
  - (1) Referring to “OPERATION, 1.5 Machinery cover”, remove the machinery cover.
  - (2) Remove the radiator cap ③ and check the radiator for coolant level.
  - (3) When it is too low, check the radiator, radiator hose, and each part of engine for water leakage.
  - (4) Add water through the water filler of radiator and securely tighten the radiator cap ③.
  - (5) Remove the cap ② of reservoir tank ① and add water up to the FULL level through the water filler.
  - (6) After the replenishment of coolant, securely mount the cap ② of reservoir tank ①.
  - (7) Referring to “OPERATION, 1.5 Machinery cover”, mount the machinery cover.

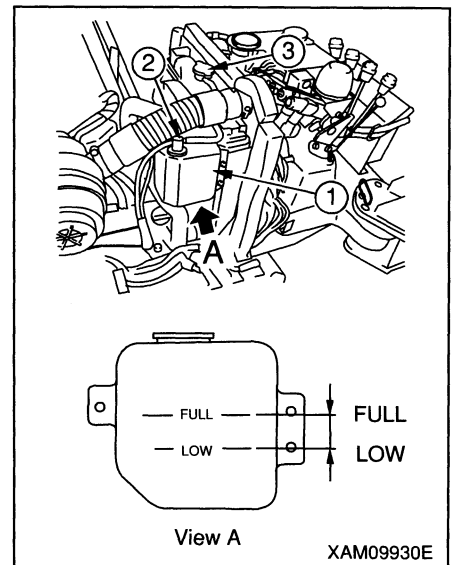
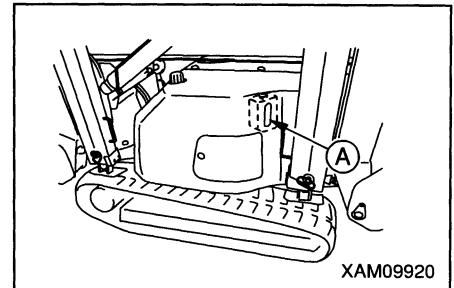

## [2] Check radiator fin, and clean it

**! WARNING**

Use of compressed air causes trash and dusts to scatter, putting you in hazardous situation. To protect you from such situation, be sure to wear safety glasses and protection mask.

**CAUTION**

- When using compressed air, reduce its pressure down to 0.20 to 0.29MPa (2 to 3kg/cm<sup>2</sup>), and blow it at a certain distance away from the fin to prevent it from being damaged.  
Damage on the fin may cause water leakage and overheat.
- In a dusty place, inspect the fin everyday and clean it, if necessary.

1. Remove the machinery cover. See “OPERATION, 1.5 Machinery cover”.
2. Blow compressed air (0.20 to 0.29MPa [2 to 3kg/cm<sup>2</sup>]) to the oil cooler ② and radiator ① to remove mud and trash which are clogging the fin.
3. Install the machinery cover. See “OPERATION, 1.5 Machinery cover”.

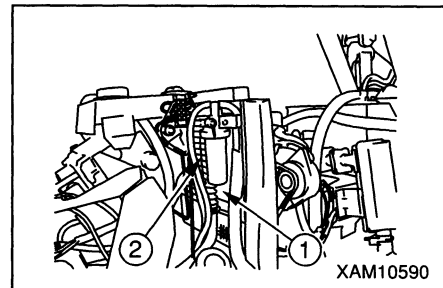

[3] Check oil level in engine, and add oil

**CAUTION**

After oil level check and replenishment, install oil level gauge properly to prevent the gauge from falling off during operation, which may cause scalding due to shooting hot oil.

**CAUTION**

- As for the oil to be used, see Part IV Inspection and Service, 5.1 Application of lubricant in accordance with ambient temperature. Use of oil which is not recommended, may shorten the service life of your engine. Be sure to replenish with recommended oil.
- Level of engine oil should be maintained properly. Excessive feed of oil may lead to its increased consumption or its pre-matured deterioration as its temperature is prone to rise. Insufficient oil on the other hand may cause seizure in engine.

1. Park the machine on level ground.
2. Open the inspection cover ① on the side surface of right machinery cover.  
To unlock the inspection cover ①, insert the key ② into the key hole and counterclockwise turn it, and then pull the cover toward you.
3. Pull out oil level gauge ③ and wipe off any oil with waste cloth.
4. Insert the gauge into filler port and pull out it again.
5. Oil level is proper if it is between the markings H and L on the gauge rod ④.
6. If oil does not reach the “L” mark, remove filler port cap ⑤ and replenish with oil through filler port.

**NOTES**

Oil should be replenished to midway between the markings H and L on level gauge rod ④.

7. After replenishment, re-install gauge rod ④ and filler port cap ⑤ securely.
8. Close the inspection cover ① and clockwise turn the key ②. Pull the inspection cover ① lightly to check that it is locked, and pull out the key ②.

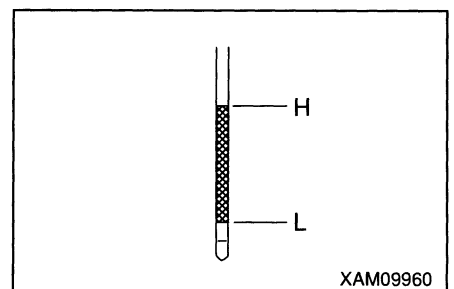
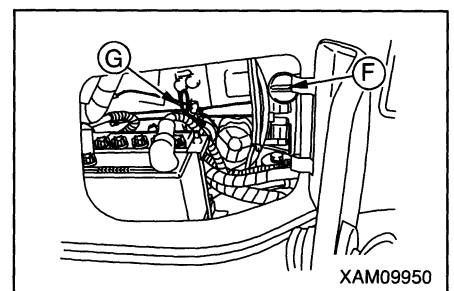
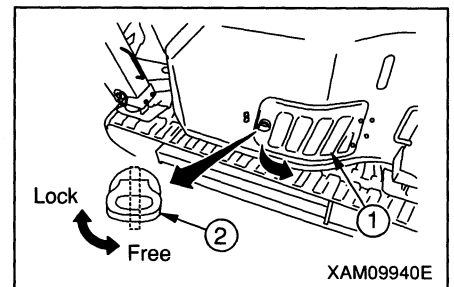

## [4] Check fuel level in fuel tank, and add fuel

**⚠ DANGER**

- As for the fuel to be used, see “MAINTENANCE, 5.1 Application of lubricant in accordance with ambient temperature.
- Be careful about fire including that of lit cigarette.
- For replenishment of fuel, be sure to shutdown the engine. Feeding fuel with engine running, may cause inflammation due to spilled fuel on heated muffler.
- Excessive feed of fuel is dangerous as it may cause spilling. Stay on the slightly lower side of specified maximum level. Any spilled fuel should be wiped off thoroughly.
- After replenishment, close the tank cap securely.

1. Turn the engine key to ON position and check the fuel gauge on monitor panel to see that the tank is full (Close to  $\text{F}$  mark).
2. If insufficient, take the cap  $\text{F}$  off the tank top and replenish with fuel through filler port while watching the fuel gauge.
3. After replenishment, turn the tank cap  $\text{F}$  to close it securely.

**NOTES**

After a day's work, be sure to fill the tank with fuel.

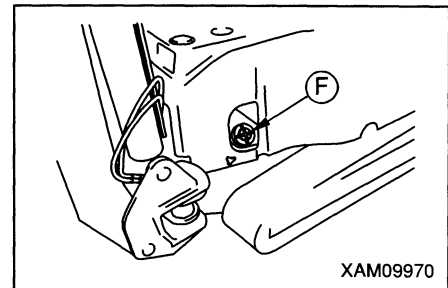
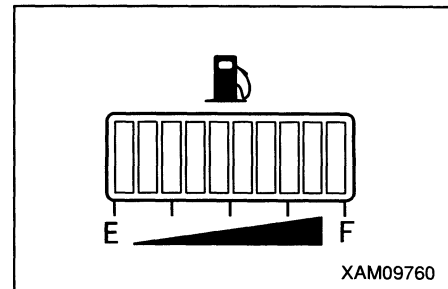



**[5] Check water separator, and clean it**

**! WARNING**

- **Water separator pot contains fuel (light oil). When you clean it, be careful about fire including cigarette.**
- **If fuel is spilled when you remove the water separator part, be sure to wipe it off.**

**CAUTION**

- **Water or trash which remains in the water separator may constitute a cause for engine trouble. Check the pot internals and remove them as necessary.**
- **When water remains in the water separator pot, a lot of mixed water in fuel tank is suspected. Referring to “MAINTENANCE, 8.7 Service in every 50 hours”, remove mixed water and trash from the fuel tank.**

1. Remove the machinery cover. See “OPERATION, 1.5 Machinery cover”.

2. Check inside of the ① water separator pot in the front side of the radiator to confirm that there is no dust accumulation, and that the ② red float keeps in touch with the bottom.  
If the ② red float is above the bottom, water is present.

3. If there is any water or trash remaining inside the water separator pot ①, clean its internals in the following manner:

- (1) Turn fuel lever ③ to horizontal position (Close) to stop flow of fuel.
- (2) Loosen retainer ring ④ by rotating it counterclockwise and remove water separator pot ①.
- (3) Pull out the element ⑤ from the pot ①.
- (4) Cleanse the water separator pot ① with light oil, before blowing its internals with compressed air (0.20 – 0.29Mpa or 2 – 3kgf/cm<sup>2</sup>) to remove surface dust.
- (5) Insert the element ⑤ to the pot ①.
- (6) Mount back the pot ① and tighten the retainer ring ④ by clockwise turning it.
- (7) Turn the fuel lever ③ to vertical position (Open)

4. Install the machinery cover. See “OPERATION, 1.5 Machinery cover”.

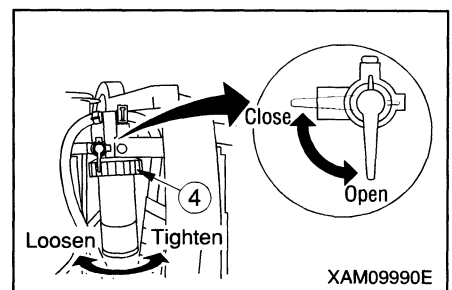
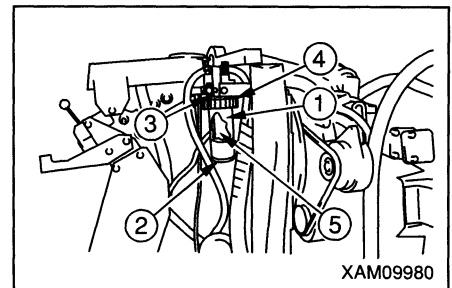

## [6] Check fuel filter

**! WARNING**

- Fuel filter contains fuel ( diesel fuel ). When replace it, be careful about fire including lit cigarette.
- If fuel is spilled, be sure to wipe it off.

**CAUTION**

Water or trash remaining in the fuel filter constitutes a cause for engine trouble. Check the fuel filter internals and remove them.

1. Remove the machinery cover. See "OPERATION, 1.5 Machinery cover".
2. Check the fuel filter to make sure trash does not remain in the filter case.
3. If trash remains within the fuel filter, replace the fuel filter in the following manner.
  - (1) Remove the fuel filter ② from the holder ①.
  - (2) Loosen the clamps ⑤ of fuel hoses ③ and ④ connecting to the fuel filter ②, and disconnect the fuel hoses ③ and ④.
  - (3) Connect the fuel hoses ③ and ④ to new fuel filter ② to assuredly prevent them from falling with the clamps ⑤.
  - (4) Insert the fuel filter ② into the holder ① to assuredly secure it.

**NOTES**

After inserting the fuel filter into the holder, lightly shake the fuel filter to check that it is firmly secured.

- (5) After replacing the fuel filter, bleed the fuel system.

4. Install the machinery cover. See "OPERATION, 1.5 Machinery cover".

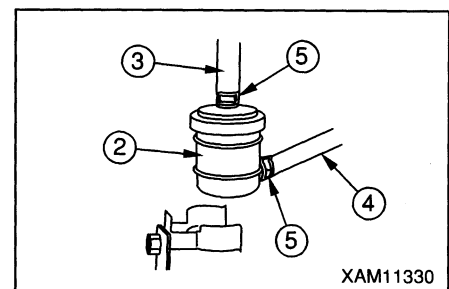
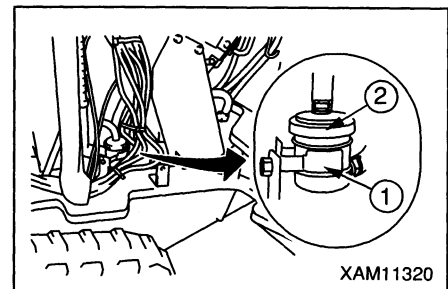

[7] Check oil level in hydraulic tank, and add oil

**! WARNING**

- When you remove hydraulic tank filler port cap, oil may gush out.  
Loosen mounting bolts of cap, slightly raise it to relieve internal pressure, remove mounting bolts, and remove cap.
- After replenishment of oil, securely tighten mounting bolts of filler port cap.  
Otherwise, mounting bolts may be loosened during operation, causing cap to fall and hot oil to gush out to produce burn.

**CAUTION**

- For the type of oil to use, see “MAINTENANCE, 5.1 Use of oil according to ambient temperature”.
- Before checking the oil level, let the machine assume travel position. Checking the oil level with the machine remaining in working position tends to cause over-filling, because oil in each cylinder may not have returned to the tank.
- Do not feed oil to exceed the level point on the gauge (red dot). Excessive filling may cause oil to gush out through air breather while traveling or during crane work.

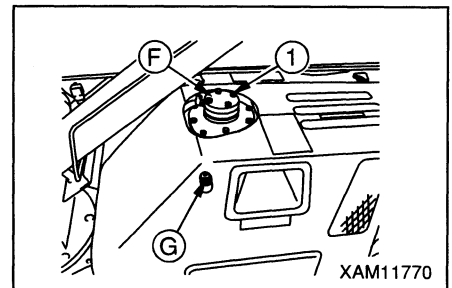

1. Check the oil level gauge (G) of the inspection hole on the left side of machinery cover to see that oil is up to the level point (red dot).
2. If oil is insufficient, remove the four mounting bolts (1) on the top surface of hydraulic tank to remove the cap of filler port (F).
3. Replenish with hydraulic oil through filler port (F) while watching the level point (red dot).
4. After the replenishment of oil, place back the cap of filler port (F) and securely tighten the four mounting bolts (1).

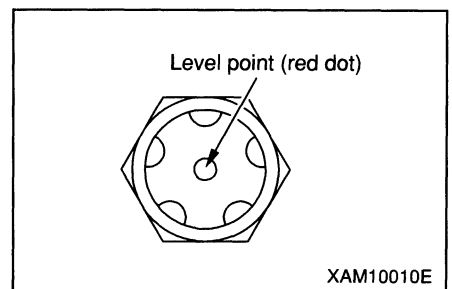

[8] Check oil level in swing machinery case, and add oil.

### **! WARNING**

After replenishment of oil, securely tighten filler port plug. Otherwise, filler port plug may fall during operation, causing hot oil to gush out to produce burn.

### **CAUTION**

- For the oil to be used, see “MAINTENANCE, 5.1 Application of lubricant in accordance with ambient temperature”.
- After the check and replenishment of oil, take measures against oil leakage by winding seal tape around threaded portion of level check plug and filler port plug, before tightening them securely.

1. Park the machine on the level ground.
2. Remove the machinery cover. See “OPERATION, 1.5 Machinery cover”.
3. Remove the filler port plug (F) from the swing reducer case, put your finger into the plug hole to check if oil fills the case up to the plug hole level.
4. If insufficient, feed gear oil through the plug hole of filler port plug (F).

### **NOTES**

Feed gear oil almost up to the filler port plug hole level.

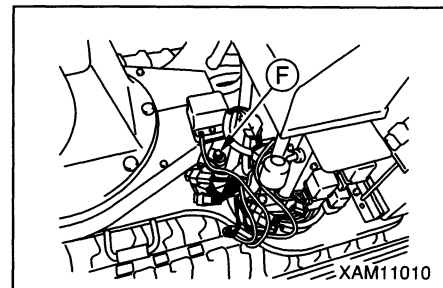

5. After the inspection and replenishment of oil, securely tighten the filler port plug (F).
6. Install the machinery cover. See “OPERATION, 1.5 Machinery cover”.

[9] Check and adjust rubber crawler tension

**CAUTION**

- For performing rubber crawler check and adjustment, set up outrigger and lift the machine so that its crawler are about 80mm off the ground.
- Tension of rubber crawler is normal, if the clearance between bottom of track roller and shoulder of crawler is 5 to 10mm at midway.
- In case crawler is loose even after packing the grease, it will be necessary to replace the rubber crawler or the seal of tension adjust cylinder. For the judgment of whether to replace, repair or continue to use the existing crawler, contact your dealer.

Because the progress of rubber crawler wear will vary depending on working conditions or ground, always watch the wear and tension. Particularly in case new machine or new crawler has been installed, after adjusting the tension to specified value, keeping to travel for 5 to 30 hours will cause initial slack to develop. Until such initial slackening period elapses, tension adjustment has to be carried out diligently. It helps avoid rubber crawler coming off due to lack of tension.

[Checking the tension]

1. Set up outrigger and lift the track by about 80mm off the ground.
  - ★ For outrigger setting up procedure, see “OPERATION, 2.12 Setting up the outrigger”, for detail.
2. Move the machine so that joint (M mark) of rubber crawler comes over the center between the shafts.
3. Measure the clearance between bottom of the track roller in the middle and shoulder of the rubber crawler.

**NOTES**

If the clearance is 5 to 10mm, the tension falls within the standard.

4. If the tension is out of such standard, make adjustment in accordance with Tension Adjustment in the next page.

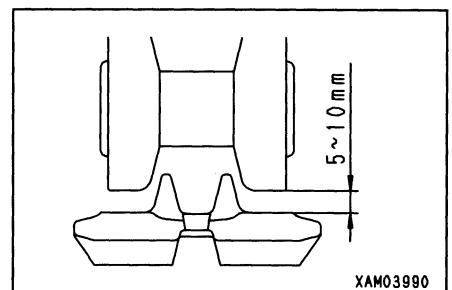
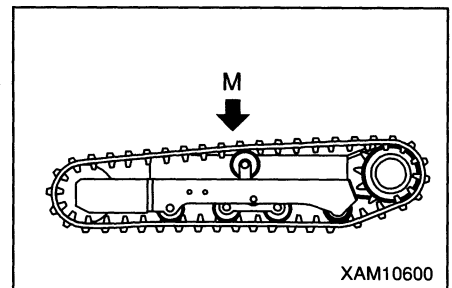

**[Tension Adjustment]**

If, as the result of rubber track tension check, the tension is weaker than standard, make adjustment in the following procedure:

Working with the track slackened (bend of rubber track being 15mm or greater), will cause the track to go off the rollers or pre-matured wear of core metal to develop.

- In case tension is weak (to increase tension)
  - ★ Have a grease gun (pump) ready.
  - 1. With 2 mounting bolts ② removed, take off the inspection cover ①.
  - 2. Pack the grease through grease valve ③ by means of grease gun.
  - 3. To confirm that the tension is proper, proceed with following:
    - (1) With the outrigger stowed away, ground the machine.
      - ★ For the outrigger stowing method, see “OPERATION, 2.23 Stowing the outrigger”.
    - (2) Let the machine travel back and forth.
    - (3) Set up the outrigger and lift the machine again by about 80mm off the ground.
      - ★ For the outrigger setting up method, see “OPERATION, 2.12 Setting up the outrigger”.
  - 4. Again, conduct the rubber track tension check. If it is not proper yet, repeat the procedure again.
  - 5. Using the 2 mounting bolts ②, reinstall the inspection cover ①.
  - 6. Stow away the outrigger and lower the machine to ground.
    - ★ For the outrigger stowing method, see “OPERATION, 2.23 Stowing the outrigger”.

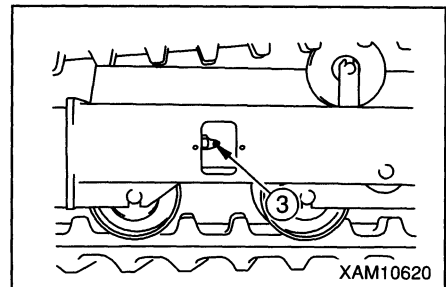
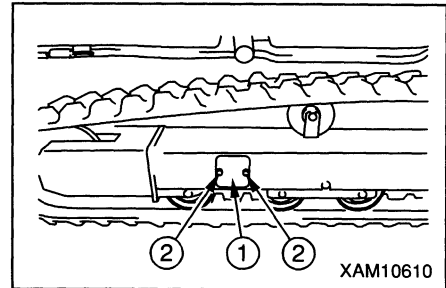

- In case the tension is strong (to reduce tension)

**⚠ WARNING**

**Grease is packed inside the rubber crawler tension adjust system, and the grease is at high pressure due to tension of the track. By making adjustment without observing following instruction, grease valve may spring out, to cause serious accident.**

- **Tension adjustment grease valve should not turned out by more than one turn. It may cause grease valve to spring out.**
- **To make tension adjustment, do not position yourself in front of the grease valve to avoid possible risk.**

1. With 2 mounting bolts ② removed, remove the inspection cover ①.
2. Loosen grease valve ③ bit by bit to let the grease come out.
3. Use care not to loosen the grease valve ③ by more than one turn.
4. If the grease does not come out smoothly, take following measures:
  - (1) Stow away the outrigger and lower the machine to ground.
    - ★ For the outrigger stowing method, see “OPERATION, 2.23 Stowing the outrigger”.
  - (2) Move the machine back and force.
  - (3) Set up outrigger and lift the undercarriage off the ground by about 80mm.
    - ★ For the outrigger setting up method, see “OPERATION, 2.12 Setting up the outrigger”.
5. Turn-in the grease valve ③.
6. Conduct the rubber crawler tension check. If the tension is still improper, repeat the adjustment again.
7. Using the 2 mounting bolts ②, reinstall the inspection cover ①.
8. Stow away the outrigger and lower the machine to ground.
  - ★ For the outrigger stowing method, see “OPERATION, 2.23 Stowing the outrigger”.

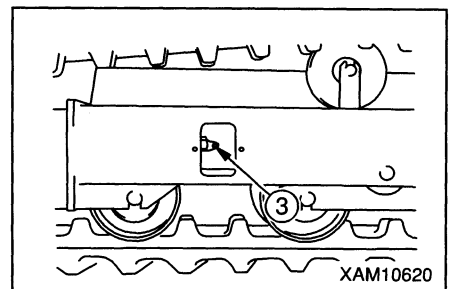
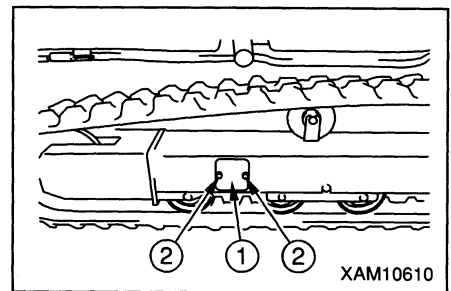

[10] Check damage and wear for rubber crawler

**CAUTION**

For making judgment whether to replace, repair or continue to use the existing rubber crawler, contact your dealer.

Your track needs to be repaired or replaced when it falls in the following condition. Contact you dealer for action.

[Lug height]

- When the lug height “a” is reduced by wear, traction force drops. If the lug height “a” is reduced to less than 5mm, replace it with new track.
- With lug having worn, if steel cord inside the rubber track is exposed over two or more links, the track should be replaced.

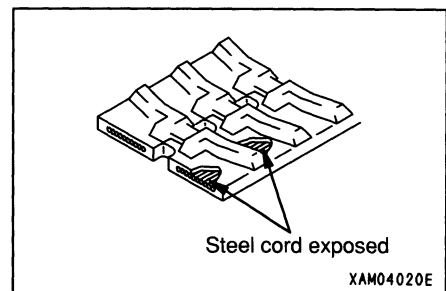
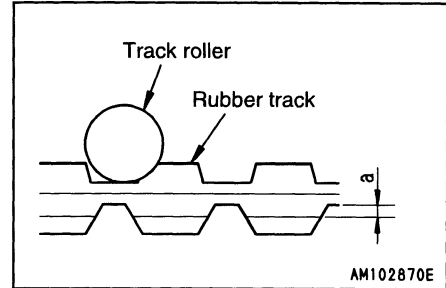

[Breakage of steel cord]

- Any rubber track with more than one half of its steel cord layer on one side is broken, should be replaced with new one.

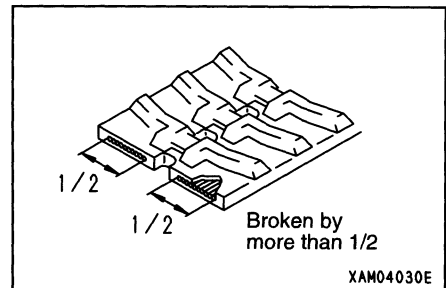

[Dropping out of core metal]

- Any rubber track with its core metal having dropped out at one or more locations should be replaced with new one.

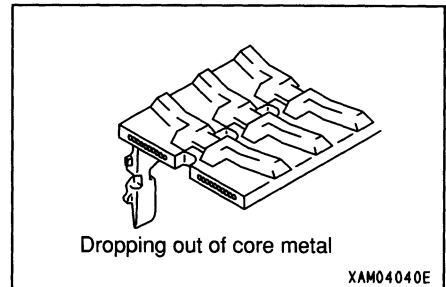

[Crack]

- Any crack which develops between rubber track lugs should be repaired when it has grown to about 30mm in length. However, even if the crack appears to be small and short, in case it exposes internal steel cord, it should be repaired immediately.

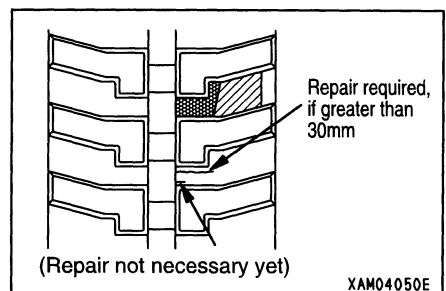



[11] Check electrolyte level

**! WARNING**

- Battery generates inflammable gas which may explode. Do not allow any fire to approach.
- Electrolyte is dangerous. Do not allow it to get in your eyes or on skin. If it has got on, wash it off with plenty of water and see doctor for treatment.
- Do not replenish with electrolyte in excess of its maximum level line indicated. It may cause fire when it leaks.

**CAUTION**

- Keep the top surface of battery clean by wiping with wet cloth.
- When required to replenish with distilled water, in order to avoid freezing, do it before starting your work the following morning.

1. Park the machine on the level ground.
2. Remove the machinery cover. See "OPERATION, 1.5 Machinery cover".
3. Check the electrolyte level by looking through the side of battery case.

**NOTES**

Clean the battery case if it has been smeared.

4. Check that the electrolyte is up to the maximum level line ①.
5. If not, remove all the battery caps ③ (x6) and replenish up to the maximum level ①.

**NOTES**

If electrolyte is spilled, refill with dilute sulfuric acid.

6. Check breather hole of battery cap ③, clean any clogged cap before tightening securely.
7. Install the machinery cover. See "OPERATION, 1.5 Machinery cover".

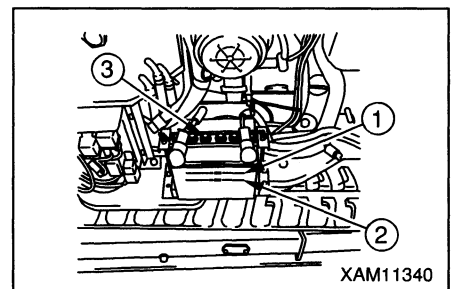

**[12] Check over-hoist alarm system**

1. Insert key to starter switch and turn it to ON position to conduct following check:

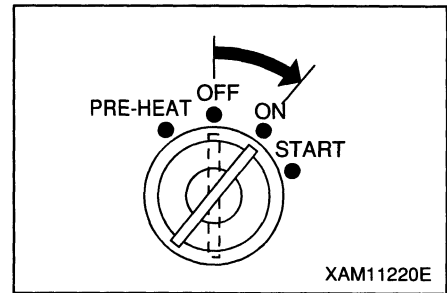

2. Place the switch ② of over-hoist alarm system at ON position to check if the alarm buzzer ① sounds.

If not, the failure of alarm buzzer of over-hoist alarm system is suspected.

Contact your dealer to receive service.

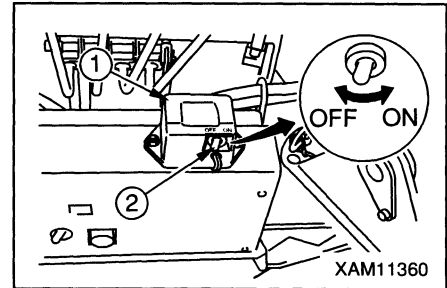

3. Press down the lever ④ of over-hoist alarm system ③ to check that the alarm buzzer stops.

If not, the failure of over-hoist alarm system is suspected.

Contact your dealer to receive service.

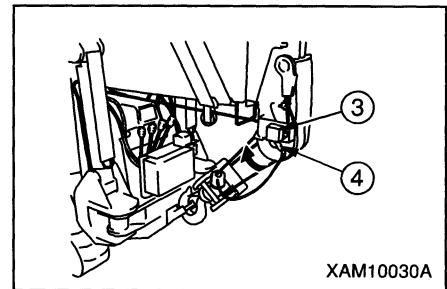

**[13] Check horn**

1. Insert key to starter switch and turn it to ON position to conduct following check:

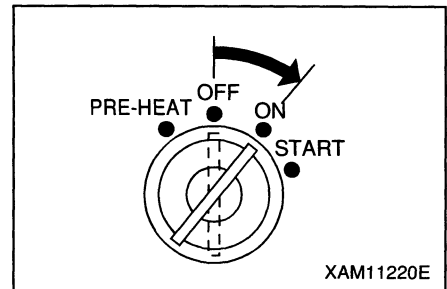

2. Press the horn switch and make sure that horn sounds. If not, trouble in the horn or a wiring failure is conceivable. Contact your dealer for repair.

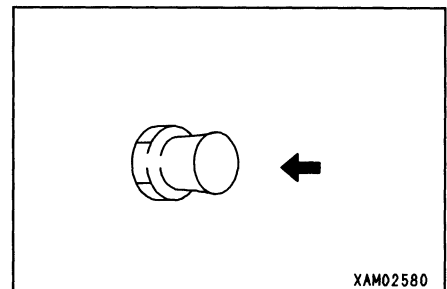

**[14] Check working light**

1. Insert key to starter switch and turn it to ON position to conduct following check:

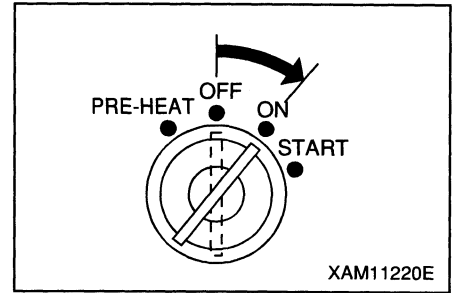

2. Pull the working light switch to see if the working light at top of the left and right No.1 boom goes on. If it does not, blown bulb or wiring failure is conceivable. Contact your dealer for repair.

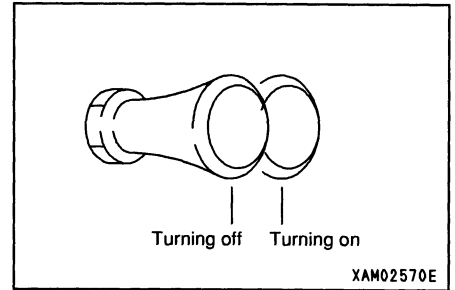

**[15] Check electric wiring**

**⚠ WARNING**

- If fuse blows frequently or there is a trace of electric wiring having short circuited, be sure to check for the cause and correct.
- Accumulation of inflammable stuff such as dead leaves, dead twig or dry grass can be a cause for fire. Be sure to remove them.
- Keep the top surface of battery clean and check breather hole in the battery cap. If it is clogged with dirt, wash it with water to eliminate clogging.

Remove the fuse holder at the travel controller to check if the tube fuse is damaged or blown.

Check the electric wiring for trace of disconnection or shortcircuit. Check the terminals for looseness and if any, tighten them. Particularly, check the wiring of battery, starter, and alternator carefully.

In addition, check if combustible materials are deposited around the battery and if any, be sure to remove them.

If the fuse is blown or a trace of disconnection or shortcircuit of electric wiring is found, contact your dealer to receive service.

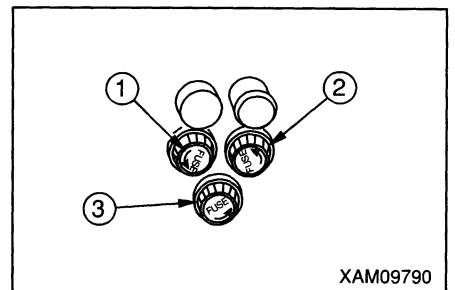

**[16] Check crack, deformation or damage of boom and frame**

Check the boom and frame for crack, deformation or any other damage, and correct them if anything abnormal is found.

**[17] Check deformation, damage or wear of wire rope**

Check the rope end fixing, rope take up condition and contact between the ropes. For the check and inspection of wire rope while winch and boom telescoping, See "OPERATION, 4. Handling of wire rope" for detail.

## [18] Check and adjust boom telescope wire rope

**⚠ CAUTION**

For performing the check and adjustment of wire rope, be sure to wear heavy working gloves.

## [Check wire rope]

Adjustment is required in case the wire rope for pulling out boom falls on such condition as shown below:

1. Position the boom horizontally and while retracting the boom, check to see that the boom pull-out wire rope is slacked at its midway. If it is slacked down, see Wire Rope Adjustment and make the adjustment.

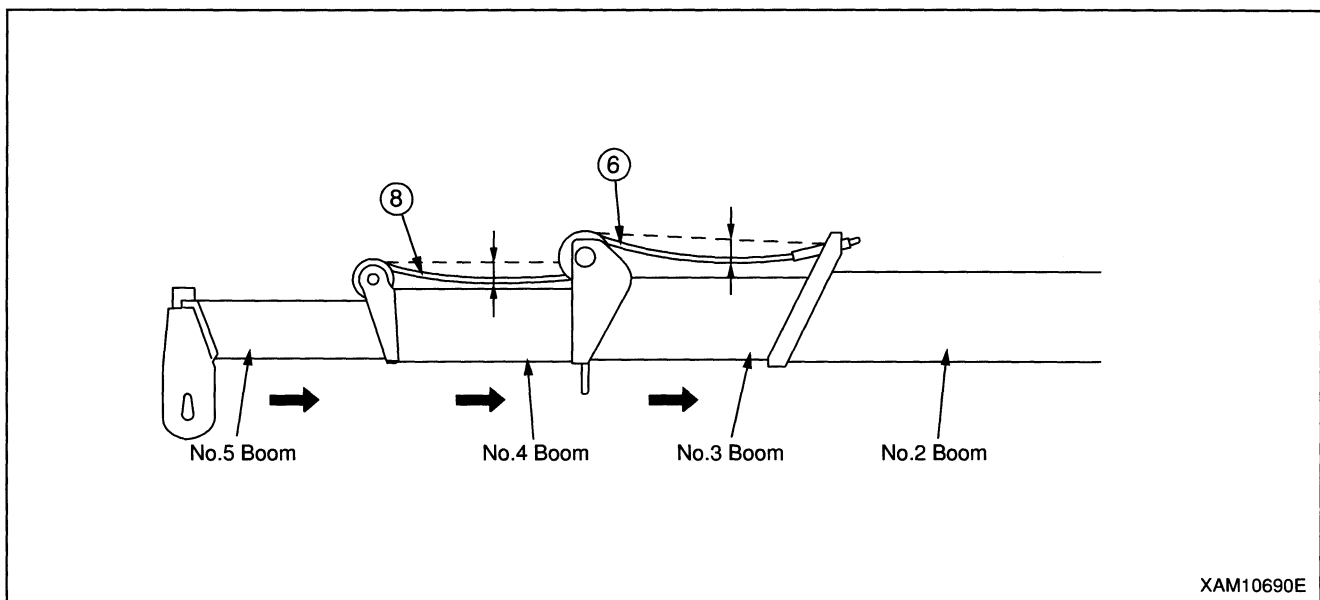

2. With the boom positioned horizontally and all the booms retracted, check to see if a clearance of 6mm or greater remains between the booms No.3 and No.4 (clearance (a)) and between No.4 and No.5 (clearance (b)). (See drawing to the right)  
If the clearance of 5mm or greater remains, make the adjustment in reference to "Adjust wire rope".

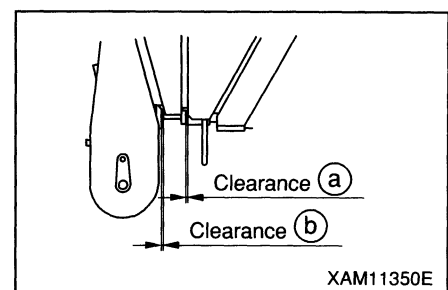

[Adjust wire rope]

**! WARNING**

**When making adjustment of each wire rope, be careful not to give any excessive tension.**

Four boom pull-out and pull-in wire ropes are in use. There is a sequence such as follows for making adjustment of these wire ropes, which should always be observed:

1. With the boom totally retracted and positioned horizontally, extend boom which makes simultaneous telescoping movement by approx. 2m.

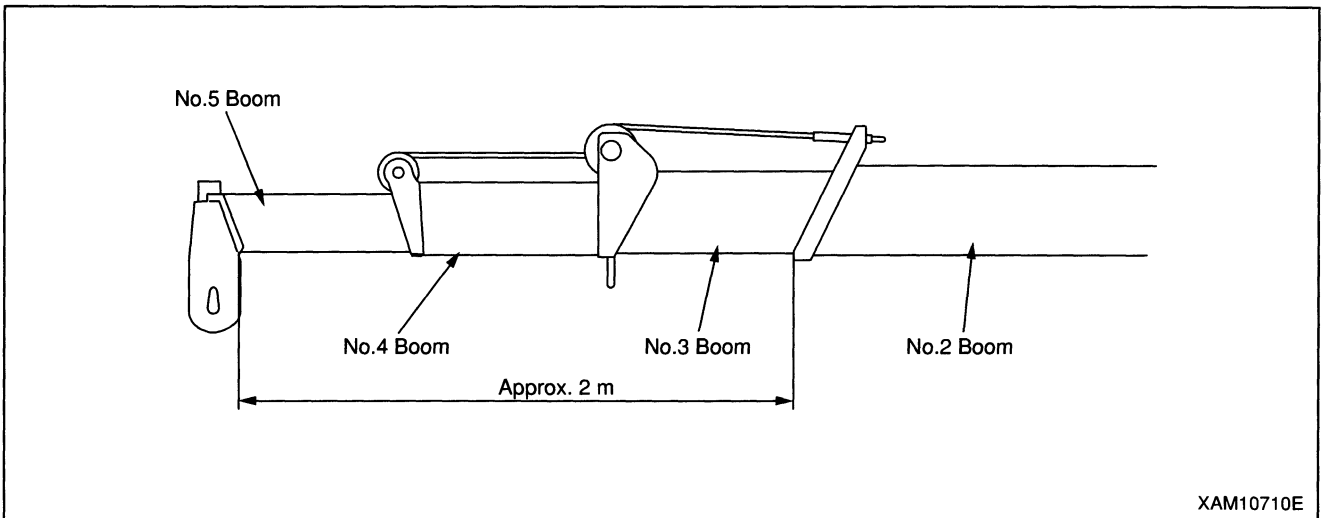

2. Retract boom slowly to stowed position. In this position, measure the clearance (a) and (b), and make following judgment:
  - If the clearance (a) is 5mm or greater, adjust the No.4 boom pull-in wire rope (5).
  - If the clearance (a) is zero, make the adjustment in accordance with “Adjust No.4 boom pull-out wire rope (6)” in step 4 below:

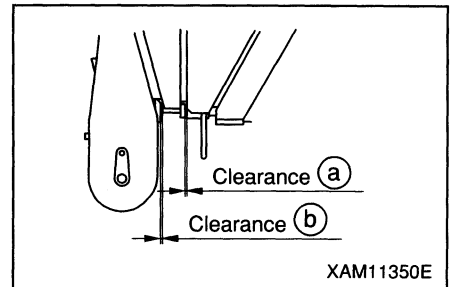

3. Adjust No.4 boom pull-in wire rope (5)
  - (1) Loosen the lock nut (9), then tighten the right and left side adjustment nut (10) evenly in the direction of tightening the No.4 boom pull-in wire rope (5) until the clearance (a) becomes zero.
  - (2) After completion of steps 1 and 2, and as the result of measurement thereof, if the clearance (a) of 5mm or greater remains, repeat the adjustment procedure.

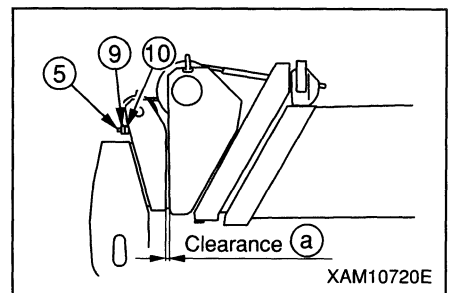

## 4. Adjust No.4 boom pull-out wire rope ⑥

- (1) Loosen the lock nut ⑪, then tighten the right and left side adjustment nut ⑫ evenly in the direction wherein the No.4 boom pull-out wire rope ⑥ is tightened, to the point immediately before the No.4 boom starts to be extended.
- (2) Retighten both right and left adjustment nuts ⑩ for the No.4 boom pull-in wire rope ⑤ further by one more turn.

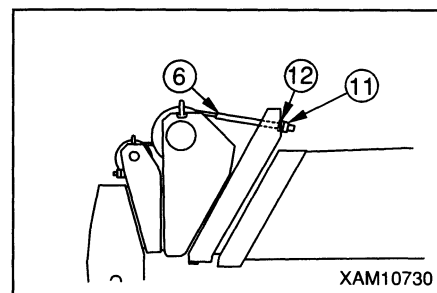

- (3) Lock the adjustment nuts ⑩, ⑫ for No.4 boom pull-in and pull-out wire ropes ⑤, ⑥ with respective lock nuts ⑨, ⑪.
- (4) After completion of steps 1 and 2, and as the result of measurement thereof, if the clearance ⑬ of 5mm or greater remains, make the adjustment in accordance with the step 5 "Adjust No.5 boom pull-in wire rope ⑦". if the clearance ⑬ is zero, make the adjustment in accordance with the step 6 "Adjust No.5 boom pull-out wire rope ⑧".

## 5. Adjust No.5 boom pull-in wire rope ⑦

- (1) Loosen the lock nut ⑬, then tighten the right and left side adjustment nut ⑭ evenly in the direction of tightening the No.4 boom pull-in wire rope ⑦ until the clearance ⑬ becomes zero.
- (2) After completion of steps 1 and 2, and as the result of measurement thereof, if the clearance ⑬ of 5mm or greater remains, repeat the adjustment procedure.

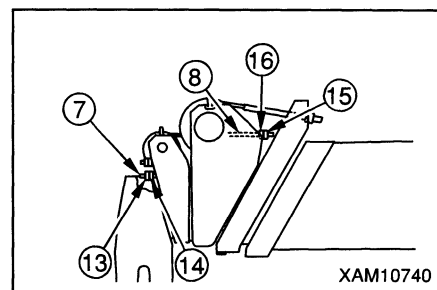

## 6. Adjust No.5 boom pull-out wire rope ⑧

- (1) Loosen the lock nut ⑮, then tighten the right and left side adjustment nut ⑯ evenly in the direction wherein the No.5 boom pull-out wire rope ⑧ is tightened, to the point immediately before the No.5 boom starts to be extended.
- (2) Retighten both right and left adjustment nuts ⑭ for the No.5 boom pull-in wire rope ⑦ further by one more turn.
- (3) Lock the adjustment nuts ⑭, ⑯ for No.5 boom pull-in and pull-out wire ropes ⑦, ⑧ with respective lock nuts ⑬, ⑮.

**[19] Inspection of operation of winch and boom****⚠ WARNING**

**For checking operation of winch and boom, be sure to see “OPERATION, 2.2 Starting the engine” and “OPERATION, 2.3 Operation and checks after the engine starts”.**

1. Check if each of lifting, lowering, boom hoisting, telescopic, and swing operations is correctly performed in accordance with operation of the control lever.
2. During the step 1 above, check if no abnormal sound is heard from any part of crane such as the boom and hydraulic motor.
3. Operate the crane under no load and check the bolts and nuts of each part for falling and looseness.
4. Check if the hook is deformed, abnormal sound is heard from the bearing, and the latch ① of wire rope is correctly functioning.

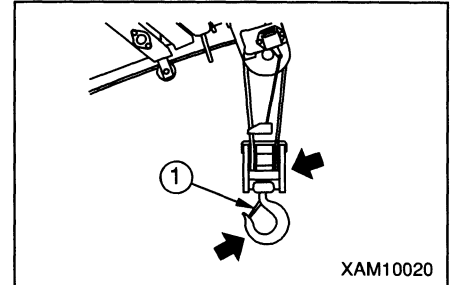

## 8.6 Every 30 hours service

### [1] Check air cleaner, and clean it

#### **! WARNING**

- Do not clean or replace air cleaner while engine is running. It may cause trouble in engine.
- When you use compressed air for cleaning the element, wear goggles because dust flies all over which may enter and damage your eyes.

#### **CAUTION**

- Air cleaner should be cleaned with the interval of 20 to 30 hours as a guide. If the machine was used in dusty area, clean the air cleaner after such work or at the next pre-work inspection.
- For cleaning air cleaner, do not tap it or hit it against something.
- Do not use such element as its pleat, gasket or seal is damaged.
- Replace the element with a new part if it has been cleaned five times, or if it has been used for one year.
- Use genuine element only.

1. Remove machinery cover. See "OPERATION, 1.5 Machinery cover" for detail.

2. Remove 2 clamps ①, then remove dust pan ②.

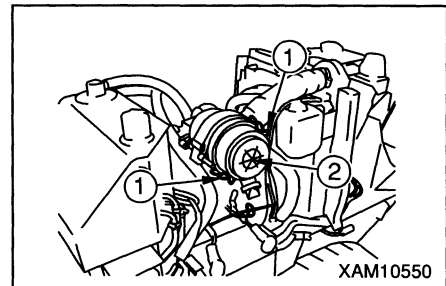

3. Pull out element ③.

4. Cover the duct hole at the back of air cleaner body ④ with clean cloth or tape to prevent dust from entering.

5. Clean the air cleaner body ④ internals.

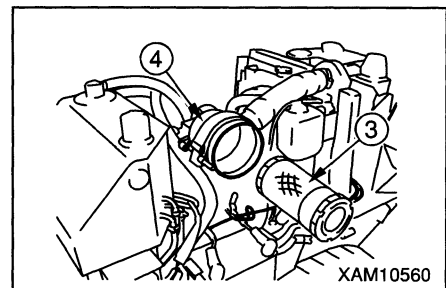

6. Blow dry compressed air (0.69MPa: 7kgf/cm<sup>2</sup> or lower) along pleats from inside of the element. Then blow along pleats from outside, before blowing from inside again.

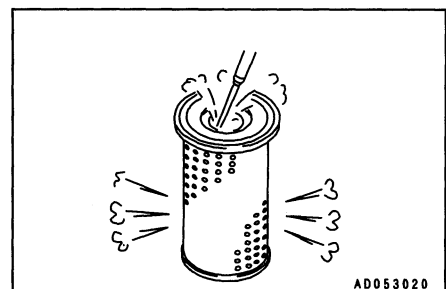



7. After cleaning, use an electric bulb to check the inside of element and replace the element if small holes or thin area is found.

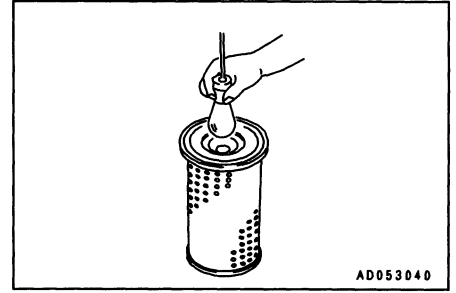

8. Remove cloth or tape cover placed on the air connector side at the back of air cleaner body ④.
9. Set the cleaned element ③ in the air cleaner body ④.
10. Set dust pan ② in the body with the TOP mark on the bottom surface facing up, then secure with 2 clamps.
11. Install machinery cover. See "OPERATION, 1.5 Machinery cover" for detail.

## 8.7 Every 50 hours service

### [1] Grease all parts of machine

#### CAUTION

- Type of grease will vary depending on the location to use. Use of improper grease can even shorten the useful life of the machine.
- During the first 100 hours when the initial break-in takes place, carry out greasing service in every 10 hours.

★ Use suitable type of grease for particular location in accordance with the chart below:

No.	Location of greasing		Type of grease
1	Greasing of boom mounting pin	1 location	Lithium grease
2	Greasing of derrick cylinder bottom end mounting pin	1 location	
3	Greasing of derrick cylinder rod end mounting pin	1 location	
4	Greasing of outrigger rotary shaft	4 locations	
5	Greasing of outrigger cylinder bottom end mounting pin	4 locations	
6	Greasing of outrigger cylinder rod end mounting pin	4 locations	
7	Greasing of swing gear	2 locations	
8	Greasing of boom slide plate	8 locations	Molybdenum grease
9	Grease coating of boom surface at each side and bottom	Each boom	
10	Grease coating of boom extending wire rope	4 ropes	Rope oil
11	Grease coating of winching wire rope	1 rope	

1. Using a grease gun, pack the grease through grease fitting as shown with arrow. (See next page.)
2. After greasing, any old grease which has been pushed out should be wiped off clean.
3. For greasing each outrigger cylinder, set up the outriggers.
4. For greasing the derrick cylinder mounting pin and slide plate on top of boom, pull back the boom hoist lever to Hoist position and hoist the boom slightly.
5. For greasing each side and bottom of boom and wire rope, push the boom telescoping lever forward to extend the boom.
6. For prevention of wear and corrosion of wire rope, coat the rope with red rope grease. When coating, remove any smear from rope surface and use brush for coating application.

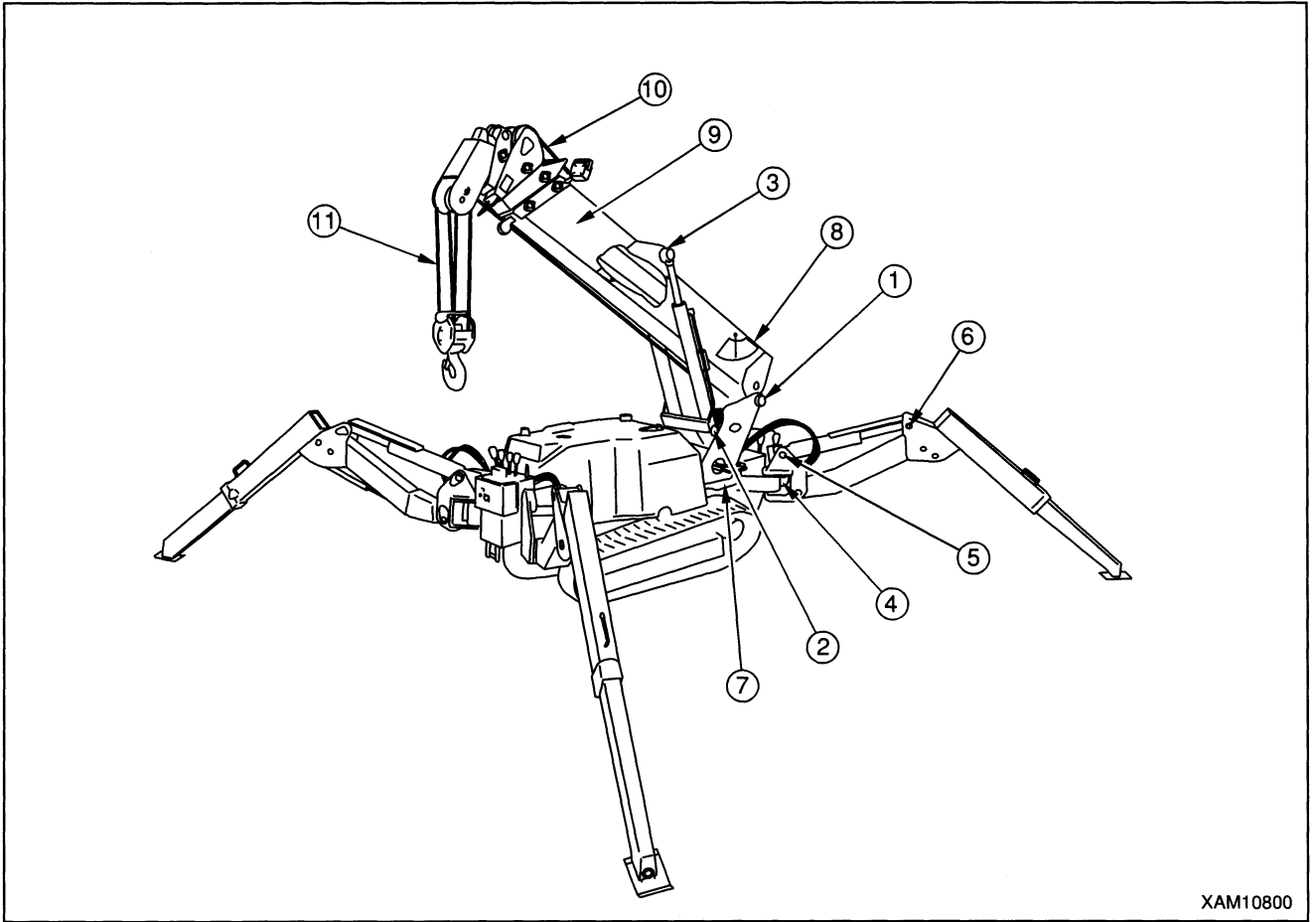

XAM10800

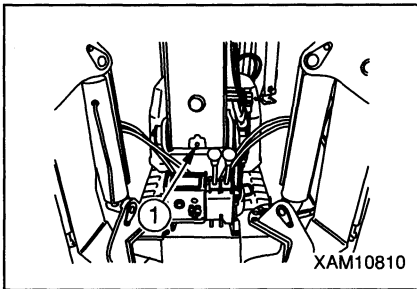

XAM10810

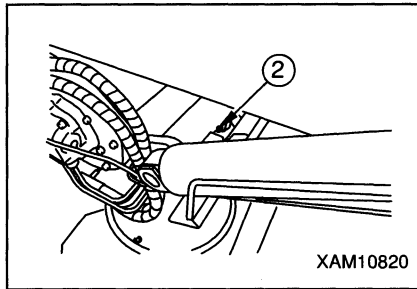

XAM10820

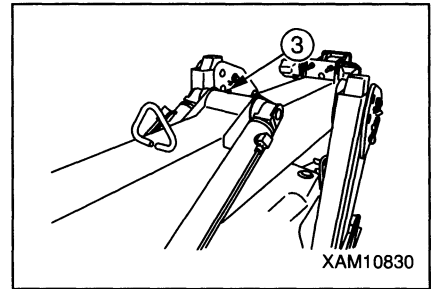

XAM10830

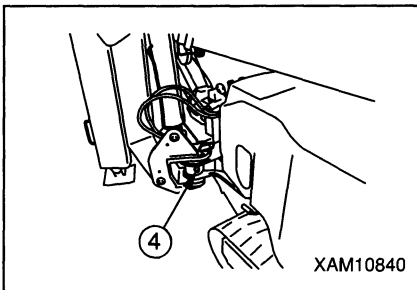

XAM10840

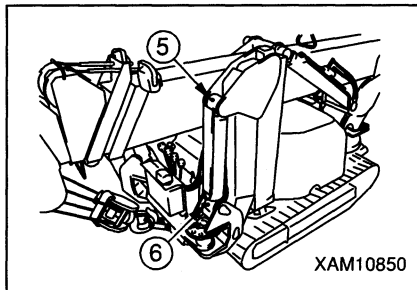

XAM10850

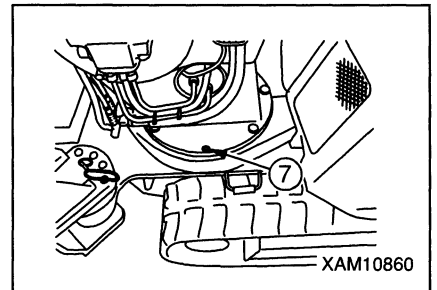

XAM10860

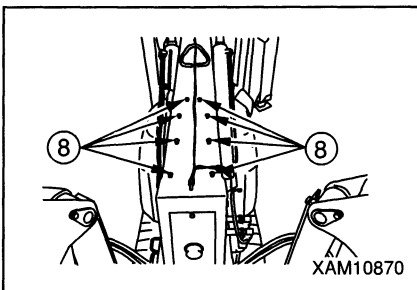

XAM10870

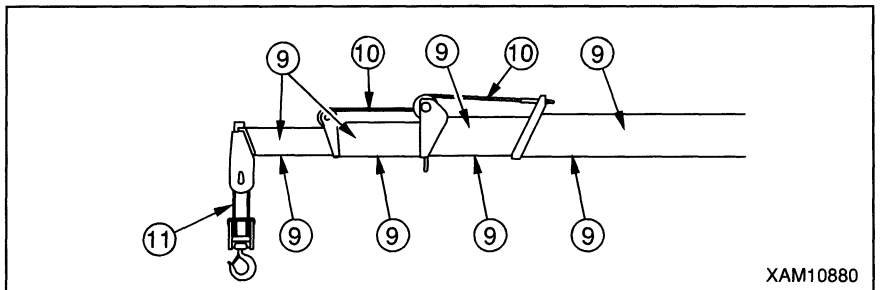

XAM10880

## [2] Drain water, sediment from fuel tank

**! WARNING**

- Be careful about fire including cigarette
- Always stop the engine when you drain fuel. Otherwise, spilled fuel may catch fire.
- After draining fuel, securely tighten drain plug of fuel tank.
- Drain plug of fuel tank is mounted directly below the machine.

To drain fuel, use outriggers to raise the machine to the maximum level and get in under the machine. If the machine is unstable and shakes, place supports (stands) under the front and rear sides of the machine to make it stable.

★ Container for receiving the drain fuel: Have a container with 1 ℓ or greater capacity ready.

1. Park the machine on level ground.
2. Set up outrigger and lift the machine to the maximum.
  - ★ For the outrigger setting up procedure, see “OPERATION, 2.12 Outrigger setting up operation”.
3. Place the container to receive the drain directly underneath the drain plug (P) of the fuel tank.
4. Turn the drain plug (P) slowly to avoid splashing fuel on yourself, and drain fuel.

**NOTES**

If fuel is not drained or difficult to be drained, remove the fuel tank cap.

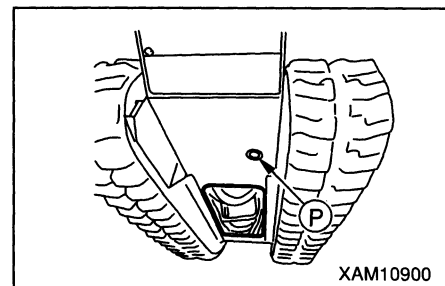

5. After drained fuel, tighten the drain plug (P) secure.
6. Stow away the outrigger and lower the machine to ground.
  - ★ For the outrigger stowing procedure, see “OPERATION, 2.23 Outrigger stowing operation”.

### 8.8 Every 100 hours service

Carry out the 30 and 50 hours services simultaneously.

#### [1] Check oil level in winch reduction gear case, and add oil

#### **⚠ WARNING**

- Oil is extremely hot immediately after operation of engine.  
Wait until oil cools down without removing inspection port plug immediately after operation.
- For inspection and replenishment of oil, be sure to stop engine.

#### **CAUTION**

- For turning the winch, release housing of hook.
- After the inspection and replenishment of oil, prevent leakage from the threaded part of oil inspection plug with sealed tape and securely tighten it.

★ Plug removal Allen key: 5mm

1. Park the machine on level land.
2. Turn the rotary of outrigger No. 4 outward so that the inspection part of winch reducer on the post side surface is visible.
3. Slowly turn the winch and stop it at a position where the oil inspection plug ⑥ is visible through the inspection hole ① on the post side surface.
4. Loosen the oil inspection plug ⑥ by turning it with the Allen key ③ to check if gear oil oozes out.
5. If not, remove the oil inspection plug ⑥ by slowly turning it and add gear oil with the oil pump ④ or the like.
6. After the replenishment of oil, securely tighten the oil inspection plug ⑥.

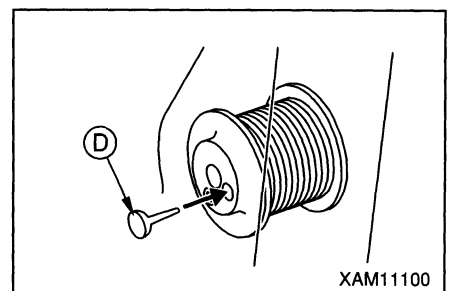
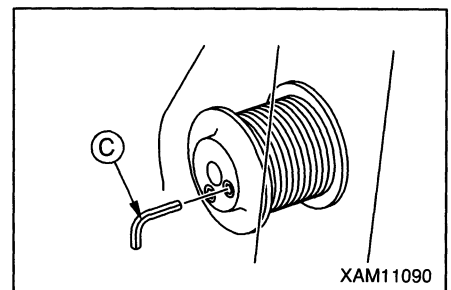
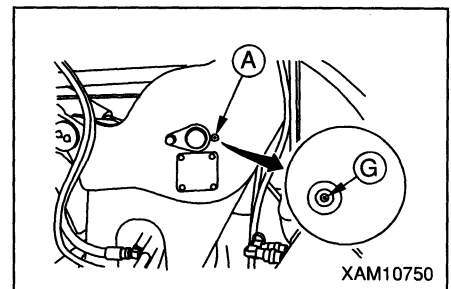

## 8.9 Every 250 hours service

★ Carry out the 30, 50 and 100 hours services simultaneously.

### [1] Check and adjust alternator belt tension

#### [Checking tension]

1. Remove machinery cover. See "OPERATION, 1.5 Machinery cover" for detail.
2. Amount of slack (A) is normal if it is 8 – 10mm with the belt depressed at its midway with finger (about 58.8N {6kgf}).

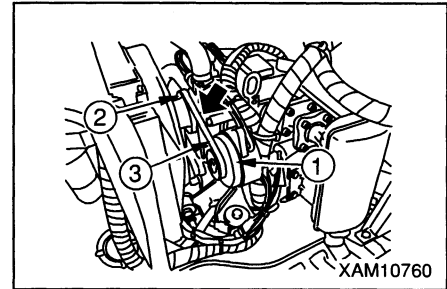

#### [Adjusting tension]

★ Have a wooden bar ready.

1. Place the bar between alternator (1) and cylinder block.
2. Loosen bottom bolt (4) and adjust bolt (5).
3. Pull back the bar and slide the alternator (1) so that the amount of slack (A) of the belt (3) is about 8 – 10mm.
4. Tighten the bottom bolt (4) first, and adjust bolt (5) and lock the alternator (1).
5. Check pulley, V groove and belt for damage and wear. In particular, make sure that the belt is not in contact with the bottom of V groove.
6. If the belt has elongated to the extent that the adjusting allowance is lost or it has scar or crack in it, replace with new one.
7. When the belt is replaced, make adjustment again after one hour of operation.
8. Install machinery cover. See "OPERATION, 1.5 Machinery cover" for detail.

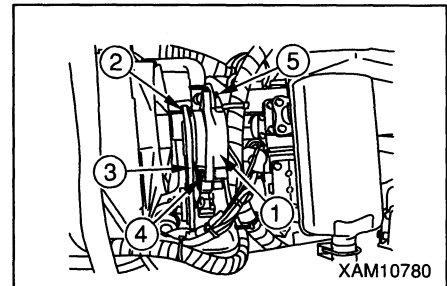
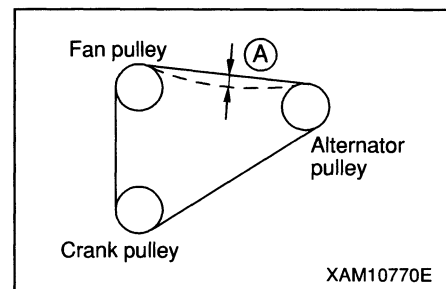

[2] Check oil level in travel motor reduction gear case, and add oil

**CAUTION**

- For the type of lubricant to use, see “MAINTENANCE, 5.1 Use of lubricant according to ambient temperature”.
- After the oil level check and replenishment, apply seal tape or the like to thread portion of oil level check plug for prevention of leakage before tightening it securely.

1. Drive the machine back and forth so that the drain plug (P) for travel motor reduction gear case comes directly at the bottom.
2. Remove the oil level check plug (G) of travel motor reduction gear case to see that oil comes out of the plug hole.
3. If insufficient, feed gear oil through the plug hole for the oil level check plug (G).

**NOTES**

Feed oil until it flows out of the plug hole.

4. After replenishment, tighten the oil level check plug (G) securely.

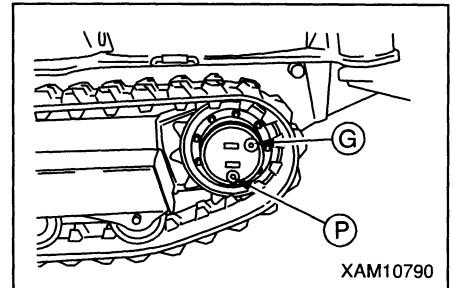

## 8.10 Every 500 hours service

★ Carry out the 30, 50, 100 and 250 hours services simultaneously.

### [1] Change engine oil and replace filter cartridge

#### **⚠ WARNING**



- Drain plug of engine oil pan is mounted to cover under control lever. When draining engine oil, use outriggers to raise the machine approximately 80mm. Be sure to place square timbers between right and left crawlers and ground for safety.
- After checking or replenishing the oil, tighten oil level gauge securely. It can come off during operation, causing hot oil to gush and you to incur scalding.
- Immediately after engine has been in operation, its various part remains hot. Do not proceed with oil replacement immediately but wait for the engine to cool to the extent that you can touch it with your hand.

#### **CAUTION**

- Make sure that old packing is not stuck to filter base. If it is, it can be a cause for oil leakage.
- For the type of oil to use, see “MAINTENANCE, 5.1 Use of lubricant according to ambient temperature”. Using any oil of not recommended type can shorten the useful life of your engine. Be sure to replenish with specified type of oil.
- Maintain the engine oil level properly.
- If the engine gets cold, oil cannot be drained completely. Wait until the engine cools down to the extent touchable and drain the oil.

★ Have a container to receive drained oil ready: 3 ℓ or greater capacity

★ Volume of oil actually to be replaced at oil pan: 2.3 ℓ

1. Park the machine on level ground.
2. Set up outrigger and lift the machine to the maximum.
  - ★ For the outrigger setting up procedure, see “OPERATION, 2.12 Outrigger setting up operation”.
3. Place a container to receive oil directly underneath the drain plug  of the oil pan.
4. Turn the drain plug  slowly to avoid spashing oil, before removing it for draining the oil.
5. Check the drained oil and if it has contained great deal of metal particle or foreign matter, contact your dealer.
6. Reinstall the drain plug .

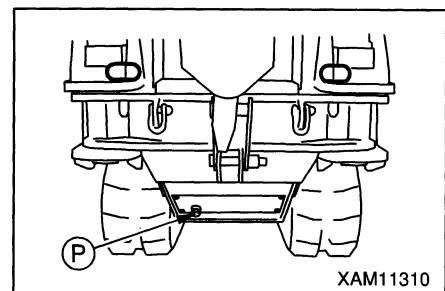



7. Stow away the outrigger and lower the machine to ground.
  - ★ For the outrigger stowing procedure, see “OPERATION, 2.23 Outrigger stowing operation”.
8. Remove machinery cover. See “OPERATION, 1.5 Machinery cover” for detail.
9. By means of filter wrench, turn filter cartridge ① counterclockwise to remove it.

**NOTES**

Wait for about 10 minutes to do so because, plenty of oil will come out if it is done immediately after stopping the engine.

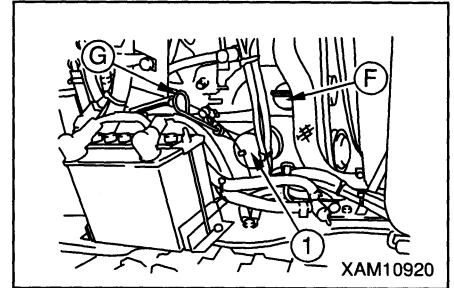

10. Clean the filter base and reinstall new filter cartridge ③ after coating its packing and thread portion with clean engine oil (or lightly with grease).

**NOTES**

When reinstalling the filter cartridge, tighten it one-half to three-quarters of a turn after the packing surface touches the sealing surface of filter base. Be sure to do it manually.

11. After replacing the filter cartridge, feed engine oil through filler port ⑥ to the specified level.
12. Pull out oil level gauge ⑦ and wipe off oil with waste cloth.
13. Insert the oil level gauge ⑦ and pull it out again.
14. Make sure that the level is between the markings (H and L) on the oil level gauge ⑦.

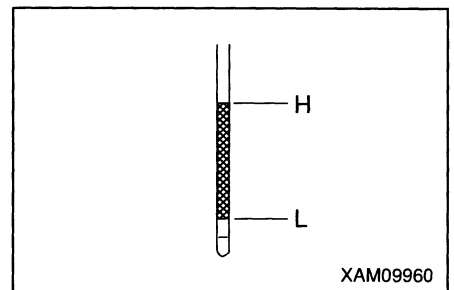

15. After changing with oil, tighten the oil level gauge ⑦ and filler port ⑥ securely.
16. Run the engine at idling speed for a while and stop engine.
17. Check that oil level is between the H and L marks on the oil level gauge ⑦.
18. Install machinery cover. See “OPERATION, 1.5 Machinery cover” for detail.

## [2] Replace fuel filter

**! WARNING**

- When replacing the fuel filter, be careful about fire and including cigarette.
- Immediately after engine has been in operation, do not proceed with fuel filter replacement because each part of engine remains hot. Wait until it cools down.
- Fuel hose must be disconnected during fuel filter replacement work. Have container to receive fuel at hand in advance to prevent fuel in fuel hose from scattering in work area.

★ Container for receiving the drain fuel: Have a container with 1 ℓ or greater capacity ready.

1. Remove machinery cover. See "OPERATION, 1.5 Machinery cover" for detail.
2. Remove fuel filter ② from holder ①.
3. Loosen clamps ⑤ at fuel hoses ③ and ④ of connected to fuel filter, then disconnect fuel hoses ③ and ④.
4. Connect fuel hoses ③ and ④ to the new fuel filter ②, then tighten clamps ⑤ secure.
5. Insert new fuel filter ② to the holder ① and it hold secure.

**NOTES**

After inserting the fuel filter into the holder, lightly shake the fuel filter to check it is firmly secured.

6. After replacing fuel filter, carry out air bleeding of fuel system.
7. Install machinery cover. See "OPERATION, 1.5 Machinery cover" for detail.

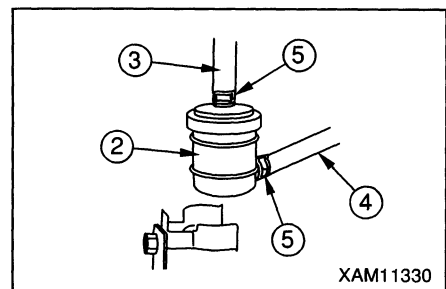
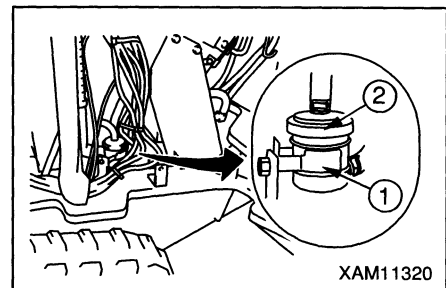

[3] Replace hydraulic oil return filter and suction filter

**! WARNING**

- Each component is extremely hot immediately after operation of engine. Do not exchange oil immediately after stopping engine. Wait until oil cools down.
- When you remove hydraulic tank cap, oil may gush out. Loosen mounting bolts of tank cap, slightly raise it to relieve internal pressure, remove mounting bolts, and remove tank cap.
- After replenishment of oil, securely tighten mounting bolts of tank cap. Otherwise, mounting bolts may be loosened during operation, causing tank cap to fall and hot oil to gush out to produce burn.

**CAUTION**

- Regarding oil for use, see “MAINTENANCE, 5.1 Use of lubricant according to ambient temperature”.
- When inspecting oil level, be sure to place the machine in Travel position. Checking oil level with the machine in Work position causes you to feed oil excessively since oil in each cylinder has not returned to the tank.
- Do not feed oil above the level point (red point) of level gauge. Feeding excessive oil may cause oil to gush out from the air breather (filler port) during travel or crane work.

★ Drained oil container: Have a minimum 30 ℓ container at hand.

★ Amount of hydraulic oil for replacement: 20 ℓ liter

1. Park the machine on level land
2. Put the machine in Travel position.
  - ★ Regarding the Travel position, see “OPERATION, 2.5 Travel position”.
3. Referring to “OPERATION, 1.5 Machinery cover”, remove the machinery cover.
4. Remove the four mounting bolts ① on the top surface of hydraulic tank and remove the filler port cap ⑥.
5. Remove the eight bolts ⑤ and detach the flange ② and suction filter ③ from the top surface of hydraulic tank.
6. Mount a new suction filter ③.
7. Apply liquid packing to the rubber plate ④, mount the flange ②, and securely tighten the eight bolts ⑤.

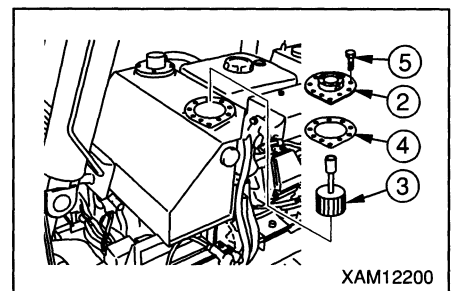
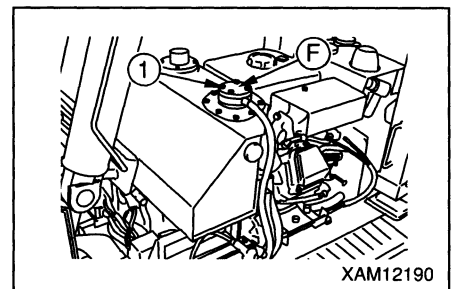

8. Remove the four bolts (8) and detach the hydraulic oil return filter (6).
9. Apply liquid packing to the rubber plate (7), mount a new hydraulic oil return filter (6), and securely tighten the four bolts (8).
10. While observing the oil gauge level (C), feed hydraulic oil up to the level point (red point) through the filler port (F).
11. After the replenishment of oil, set the cap of filler port (F), and securely tighten the four mounting bolts (1).
12. After the replacement of the hydraulic oil return filter and suction filter, bleed the hydraulic circuit following the procedures below.
  - (1) Wait the piping and hydraulic system equipment are filled with oil and start the engine.  
Continue to run the engine at low idling for 10 minutes.
  - (2) With the engine rpm keeping low, slightly operate each crane control lever to operate each cylinder and winch motor slowly.  
Do not operate the boom hoisting cylinder and telescopic boom cylinder to the stroke end, but stop them at a position approximately 100mm before the stroke end.  
Repeat this four to five times.
  - (3) Extend the outriggers and make the outrigger cylinders telescope in the condition that the machine does not float.  
When making the outrigger cylinder telescope, do not operate it to the stroke end, but stop it at a position approximately 100mm before the stroke end. Repeat this four to five times.

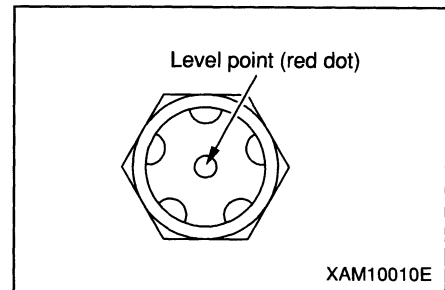
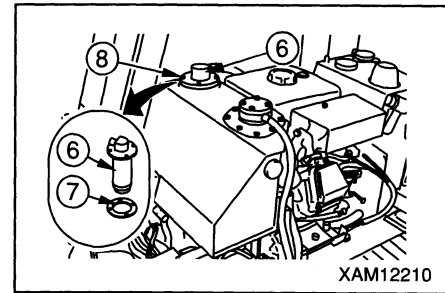

**8.11 Every 1000 hours service**

★ Carry out the 30, 50, 100, 250 and 500 hours services simultaneously.

**[1] Replace air cleaner**

**⚠ WARNING**

**Do not clean or replace air cleaner while engine is running. It may cause trouble in engine.**

**CAUTION**

- Do not use such element as its pleat, gasket or seal is damaged.
- Replace the element with a new part if it has been cleaned five times, or if it has been used for one year.
- Use genuine element only.

1. Remove machinery cover. See “OPERATION, 1.5 Machinery cover” for detail.

2. Remove 2 clamps ①, then remove dust pan ②.

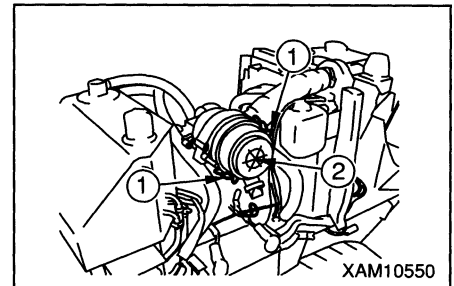

3. Pull out element ③.

4. Cover the duct hole at the back of air cleaner body ④ with clean cloth or tape to prevent dust from entering.

5. Clean the air cleaner body ④ internals.

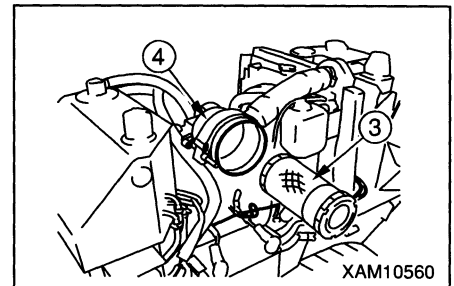

6. Remove cloth or tape cover placed on the air connector side at the back of air cleaner body ④.

7. Set a new element ③ in the air cleaner body ④.

8. Set dust pan ② in the body with the TOP mark on the bottom surface facing up, then secure with 2 clamps.

9. Install machinery cover. See “OPERATION, 1.5 Machinery cover” for detail.

[2] Clean inside cooling system

**! WARNING**

- Right after engine has been in operation, coolant is hot and draining it may cause scalding. Wait until the engine cools down.
- While coolant is hot, do not remove the cap. It may cause hot water to gush. With the temperature having dropped, if you are to remove the cap, rotate it slowly to let the pressure escape.
- Do not stand in front of or behind the machine when starting engine for flushing inside of cooling system. It is dangerous since the machine may suddenly start to move.
- Anti-freeze is inflammable. Do not hold flame near it.  
Do not smoke when handling anti-freeze.

**CAUTION**

- Use tap water for cooling water. If there is no choice but to use river water, well water or simple waterworks water, contact us or our sales service dealer.
- Use of the antifreeze densitometer is recommended for the antifreeze ratio control.

Perform coolant system cleaning and coolant replacement in accordance with the chart below:

Type of anti-freeze	Cooling system cleaning and coolant replacement
Anti-corrosion, all season type	Every other year (in fall) or every 4000 hours, whichever falls first
All season type	Every year (in fall) or 2000 hours, whichever comes first.
One winter season type	Biannually (spring and fall). Anti-freeze to be added in fall only.
Where anti-freeze is not used	Biannually or every 1000 hours, whichever comes first

Park the machine on level land for the cleaning and replacement. Mixing ratio depends on local temperature but in order to secure anti-corrosion effect, 30% by volume is the minimum. To determine the ratio of mixing anti-freeze in water, find out the lowest local temperature experienced in the past and use the Chart of Water and Anti-freeze Mixing Ratio shown below. In practice, set the temperature for about 10°C below the minimum temperature experienced.

Chart of Water and Anti-freeze Mixing Ratio

Minimum (°C)	Above -15	-20	-24	-29
Mixing quantity ( ℓ )				
Quantity of anti-freeze	0.6	0.7	0.8	0.9
Quantity of water	1.5	1.4	1.3	1.2

- Have a minimum 3 ℓ container to receive anti-freeze-mixed water at hand.
  - Have a filling hose at hand.
1. Referring to “OPERATION, 1.5 Machinery cover”, remove the machinery cover.
  2. Slowly turn the radiator cap ③ until it touches the stopper to relieve the internal pressure of radiator.
  3. After it is relieved, turn the radiator cap ③ further while pressing it until it touches the stopper, and remove it.
  4. Place the container to receive coolant (anti-freeze-mixed water) under the drain valve ④ below the radiator.
  5. Open the drain valve ④ to drain coolant. After completing the drainage, close the drain valve ④.
  6. Feed city water through the radiator water filler up to almost the water filler cap.
  7. Open the drain valve ④, run the engine at low idling, and flush it for 10 minutes with running water.

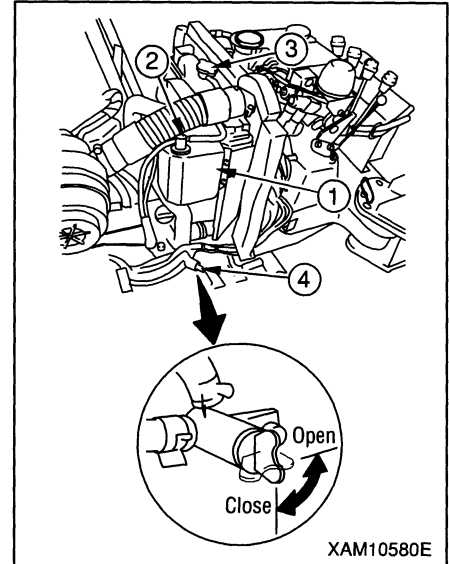

**CAUTION**

- During flushing with running water, adjust the amount of water to feed and the amount of water to drain so that the radiator is always filled with water.
- During flushing with running water, keep watch on the water filling hose so as not to being detached from the water filler port of radiator.

8. After flushing with running water, stop the engine to stop feeding water, and drain city water as it is. After draining the water, close the drain valve ④.
9. Flush it with cleanser.

**NOTES**

Regarding flushing with cleanser, follow the instructions given on the cleanser container.

10. After flushing with cleanser, open the drain valve ④ to drain the cleanser. After draining it, close the drain valve ④.

11. Feed city water through the water filler port of radiator up to near the water filler port cap.
12. Open the drain valve ④, run the engine at low idling, and flush it with running water until clean water comes out.

**CAUTION**

- During flushing with running water, adjust the amount of water to feed and the amount of water to drain so that the radiator is always filled with water.
- During flushing with running water, keep watch on the water filling hose so as not to be detached from the water filler port of radiator.

13. When clean water comes out, stop the engine, stop feeding water, and drain it. After draining it, close the drain valve ④.
14. Feed anti-freeze-mixed city water through the water filler port of radiator up to the water filler port cap.

**NOTES**

Regarding the anti-freeze and city water mixing ratio, refer to above-mentioned Chart of Water and Anti-freeze Mixing Ratio.

15. Run the engine for five minutes at low idling with the radiator cap ③ off, and run the engine further for five minutes at high idling to bleed the cooling system.
16. Stop the engine and wait approximately three minutes. Feed city water through the water filler port of radiator up to near the water filler port cap. Close the radiator cap ③.
17. Remove the reservoir tank ①, drain coolant in the tank, and flush its inside.
18. Reinstall the reservoir tank ①, feed city water up to the FULL level through the water filler port, and mount the cap ② firmly.
19. Referring to "OPERATION, 1.5 Machinery cover", mount the machinery cover.

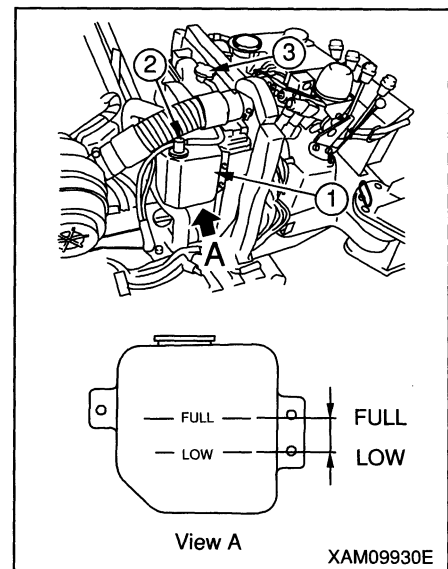



[3] Change oil in hydraulic tank

**⚠ WARNING**

- Replace the element with a new part if it has been cleaned five times, or if it has been used for one year.
- Removing the hydraulic oil filler may cause oil to gush out. The filler should be removed after turning it out slowly to have the internal pressure escape.
- After replenishing with oil, tighten the filler securely. The filler may fall off during operation, causing you to incur scalding due to hot oil that gushes out.

**CAUTION**

- For the type of oil to use, see “MAINTENANCE, 5.1 Use of lubricant according to ambient temperature.
- Before checking the oil level, have the machine assume travel position. Checking the level with the machine in working position may cause you to judge the level to be low and feed oil excessively.
- After replacing hydraulic oil, do not start the engine until the piping and hydraulic system equipment are filled with oil.
- After replacing oil, do not start engine until oil reaches all over the piping and hydraulic system equipment.

- ★ Have a container to receive drained oil ready: 40 ℓ or greater capacity
- ★ Amount of hydraulic oil tank for replacement: 20 ℓ

1. Park the machine on level ground.
2. Have the machine assume Travel Position
  - ★ See “OPERATION, 2.5 Travel Position of the Machine” for detail.
3. Remove machinery cover. See “OPERATION, 1.5 Machinery cover” for detail.
4. Remove 4 mounting bolts ① and remove filler port ② at the hydraulic tank top.
5. Place the container directly under the drain cap ③ to receive drained oil.
6. Turn the drain cap ③ slowly to avoid splashing oil, before removing it for draining the oil.
7. Check the drained oil and if it has contained a great deal of metal particle or foreign matter, contact your dealer.
8. Install the drain cap ③.

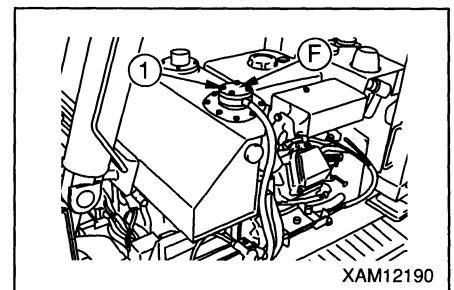

XAM12190

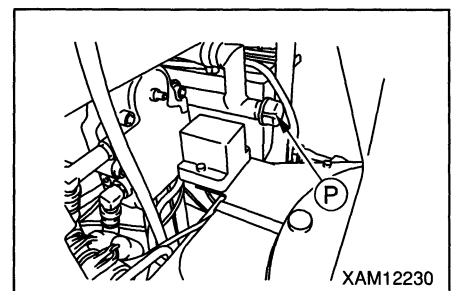

XAM12230

9. Remove filler port ⑥ at the hydraulic tank top, then fill hydraulic oil through filler port while watching the oil level gauge.
10. After changing oil, set the filler port ⑥ and tighten 4 mounting bolts ① secure.
11. After changing oil, bleed air in accordance with the following sequence:
  - (1) Wait until piping and hydraulic equipment have filled with oil before starting the engine. After engine has been started, continue to idle it for 10 minutes.
  - (2) While leaving the engine to run at low speed, operate each crane control lever for small range to have each cylinder and winch motor actuate slowly. Do not let boom hoisting as well as boom telescope cylinders actuate to stroke end, but let it stop at about 100mm before the stroke end. Repeat this procedure 4 or 5 times.
  - (3) Extend outriggers and actuate outrigger cylinders to such extent that the machine is not lifted. For telescoping the outrigger cylinders, too, do not have them actuated to their stroke ends but let them stop at about 100mm before the end. Repeat this action 4 or 5 times.

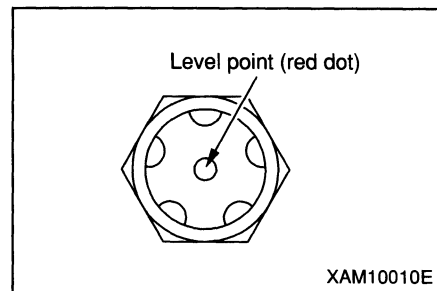

**[4] Change oil in swing machinery case**

**! WARNING**

**Drain plug of the swing machinery case is located at directly bottom of the machine. For draining the oil, set up the outrigger and lift the machine to the maximum so you can enter underneath.**

**CAUTION**

- For the oil to use, see “MAINTENANCE, 5.1 Use of lubricant according to ambient temperature”.
- When changing the oil, apply seal tape or the like to thread portion of drain plug and filler port plug for prevention of leakage before tightening them securely.

- ★ Container for receiving the drain oil: Have a container with 1 ℓ or greater capacity ready.
- ★ Actual amount of swing machinery case changing oil: 0.6 ℓ

1. Park the machine on level ground.
2. Set up outrigger and lift the machine to the maximum.
  - ★ For the outrigger setting up procedure, see “OPERATION, 2.12 Outrigger setting up operation”.
3. Place the container to receive the drain directly underneath the drain plug ① of the swing machinery case.
4. Turn the drain plug ① slowly to avoid splashing the oil and drain the oil.
5. Check the drained oil to see if it contains plenty of metal particle or other foreign matter. If yes, contact your dealer.
6. Install the drain plug ①.
7. Stow away the outrigger and lower the machine to ground.
  - ★ For the outrigger stowing procedure, see “OPERATION, 2.23 Outrigger stowing operation”.
8. Remove machinery cover. See “OPERATION, 1.5 Machinery cover” for detail.
9. After removing the filler plug ② of the swing machinery case, feed gear oil through the plug hole.
  - ★ Fill it up to the plug hole opening.
10. After changing oil, tighten the filler plug ② securely.
11. Install machinery cover. See “OPERATION, 1.5 Machinery cover” for detail.

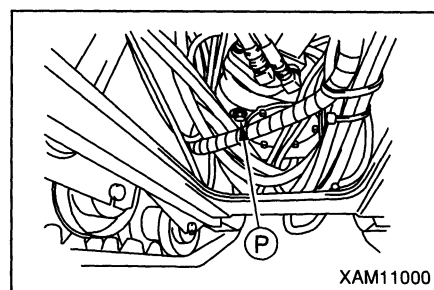

XAM11000

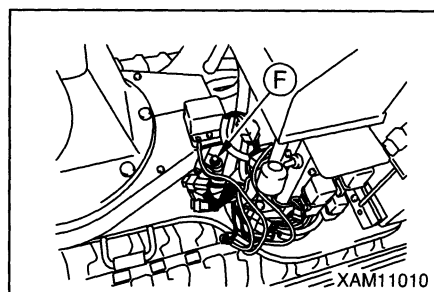

XAM11010

## [5] Change oil in winch reduction gear case

**! WARNING**

Immediately after the engine has been in operation, various parts of engine remains hot. Do not proceed with oil replacement immediately but wait until the oil cools down completely.

**CAUTION**

- For the oil to use, see Part IV Inspection and Service 5.1 Use of lubricant according to ambient temperature.
- When changing oil, apply seal tape or the like to thread portion of oil level check plug and filler plug for prevention of later leakage, and tighten them securely.

- ★ Container for receiving drained oil: Have a container with capacity of 1 ℓ or greater ready.
- ★ Amount of winch reduction gear case oil for changing: 0.5 ℓ

1. Park the machine on level ground.
2. Turn the rotary of outrigger No. 4 outward so that the inspection part of winch reducer case on the post side surface is visible.
3. Remove the four mounting bolts ② to remove the inspection cover ①.
4. Slowly turn the winch to a position where both the oil inspection plug ③ and drain plug ④ are visible.
  - (1) Stop the winch at a position where the oil inspection plug ③ is visible through the inspection hole ⑤.
  - (2) Stop the winch at a position where the drain plug ④ of reducer case is visible at the upper part of the inspection hole ⑥.
4. With the Allen key ⑦, turn the drain plug ④ to remove it.
5. Mount the elbow ⑧ for draining oil to the screw hole of drain plug ④.
6. Place the container ⑨ to receive drained oil just below the elbow ⑧.

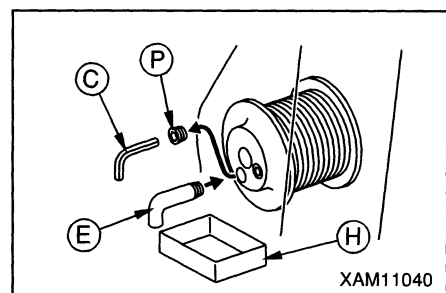
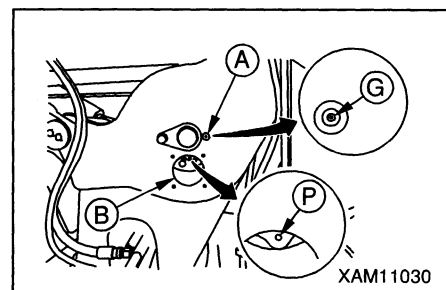
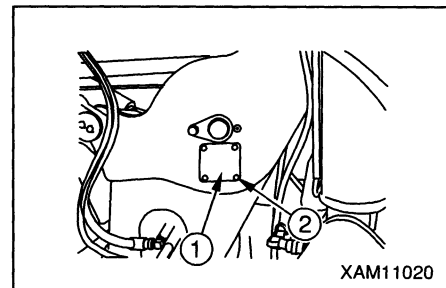

7. With the Allen key ③, turn the oil inspection plug ④ to remove it. The gear oil in the reducer case is drained.
8. After it is completely drained, detach the elbow ⑤, reinstall the drain plug ⑥, and securely tighten it.
9. Reinstall the inspection cover ① and tighten the four mounting bolts ②.
10. Feed gear oil through the hole of oil inspection plug ④ with the oil pump ⑦.

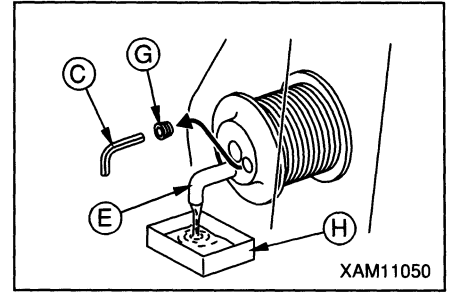

**NOTES**

Feed gear oil until it flows out from the hole of oil inspection plug.

11. After the replenishment of oil, securely tighten the oil inspection plug ④.

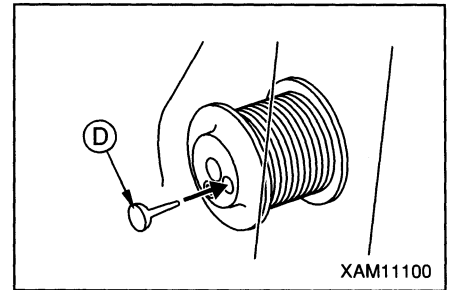

**NOTES**

After the replacement of oil, do not hoist a load for about five minutes, but perform a proper break-in of winch

## [6] Change oil in travel motor reduction gear case

**CAUTION**

- For the oil to use, see “MAINTENANCE, 5.1 Use of lubricant according to ambient temperature”.
- When changing the oil, apply seal tape or the like to thread portion of drain plug and filler port plug for prevention of leakage before tightening them securely.

- ★ Container for receiving the drain oil: Have a container with 1 ℓ or greater capacity ready.
- ★ Amount of travel motor reduction gear case oil for changing: 0.33 ℓ

1. Park the machine on level ground.
2. Drive the machine back and forth so that the travel reducer case drain plug (P) comes directly to the bottom.
3. Place a container directly under the drain plug (P) (lower) to receive the drained oil.
4. Turn the oil check plug (G) and drain plug (P) slowly to avoid splashing oil and drain the oil.
5. Check the drained oil to see if it contains metal particle or other foreign matter. If yes, contact your dealer.
6. Reinstall the drain plug (P).
7. Feed gear oil through the hole for oil level check plug (G).

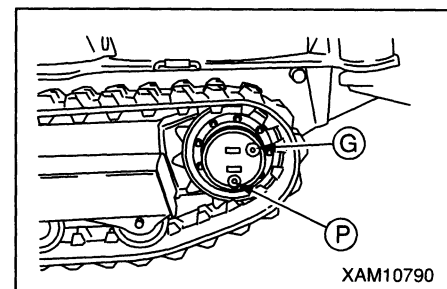
**NOTES**

Feed oil until oil flows out of level check hole.

8. After replenishment, tighten the oil level check plug (G) securely.

## 8.12 Every 2000 hours service

- Carry out the 30, 50, 100, 250, 500 and 1000 hours services simultaneously.

### [1] Check and adjust engine valve clearance

For checking and adjusting of valve clearance, special tools are required. Contact your dealer.

### [2] Check alternator and starter

**CAUTION**

**If you start the engine frequently, receive service in every 1000 hours.**

Since brushes may be worn out and grease on bearings may run out, contact your dealer to receive service.

# MEMO



# SPECIFICATIONS

1. Main data and specifications ..... 5- 2

## 1. Main data and specifications

## 1.1 Specifications chart

System and Item		MC-285C
Weight and dimension	Machine weight	1720 kg
	Overall length × width × height	2715mm × 750mm × 1440mm
	Distance between center of idler and sprocket	1178mm
	Distance between center of crawlers (Track gauge)	550mm
	Width of crawler	200mm
	Min. ground clearance	133mm
Performance	Crane capacity	2.82t × 1.4m
	Max. working radius	8.205m
	Max. lifting height above ground	8.7m
Winch system	Type	Hydraulic motor driven within brake, deferential planetary gear type, with counter balance valve (within drum type)
	Hook hoist speed	8m/min (3-layer, 4-part reeving)
	Hoist wire rope	6 × Fi(29) IWRC %, $\phi$ 7m × 46m
Telescoping system	Type	Sequential hydraulic cylinders × 2 + Wire rope telescoping system × 2
	Type of boom	Fully automatic 5-stage boom with pentagonal section (3 to 5 stage: simultaneous telescoping)
	Boom length	2.535m × 4.075m × 5.575m × 7.075m × 8.575m
	Boom telescoping stroke/time	6.04m / 22 sec
Boom hoist system	Type	Hydraulic double acting cylinder, direct acting type × 2
	Hoist angle/time	0 to 80° / 14sec
Swing system	Type	Swing bearing support, hydraulic motor drive, worm and spur gears, worm self-lock
	Swing angle/time	360° / 57 sec
Outrigger system	Type	1st stage with flexible stay damper, 2nd stage manual pullout, hydraulic cylinder direct acting type
	Max. extended width	(Lateral) 4580mm × (Front) 4530mm × (Rear) 3810mm
Travel system	Type	Hydraulic motor driven, Step-less speed changer
	Travel speed	0 to 2.2km/h
	Grade ability	20°
	Ground pressure	43.2MPa {0.44kg/cm <sup>2</sup> }
Hydraulic system	Hydraulic pump	Variable piston pump (6cc/rev × 2)
	Rated pressure	20.6MPa {210kg/cm <sup>2</sup> }
	Hydraulic tank capacity	20 little
Engine	Model	Yanmar 2TNE68-MB
	Type	Vertical, 4-cycle, water cooled diesel engine
	Displacement	0.523 little {523cc}
	Rated output	6.57kW / 2600min <sup>-1</sup> {9PS/2600rpm}
	Fuel tank capacity	12 little / diesel fuel
Battery	Type	30A19L
Safety system		Over-hoisting alarm system, load indicator, hydraulic safety valve, load meter, Hydraulic automatic lock system, lifting rope stopper lever, level instrument, machine inclination alarm system

**1.2 Dimension drawing**

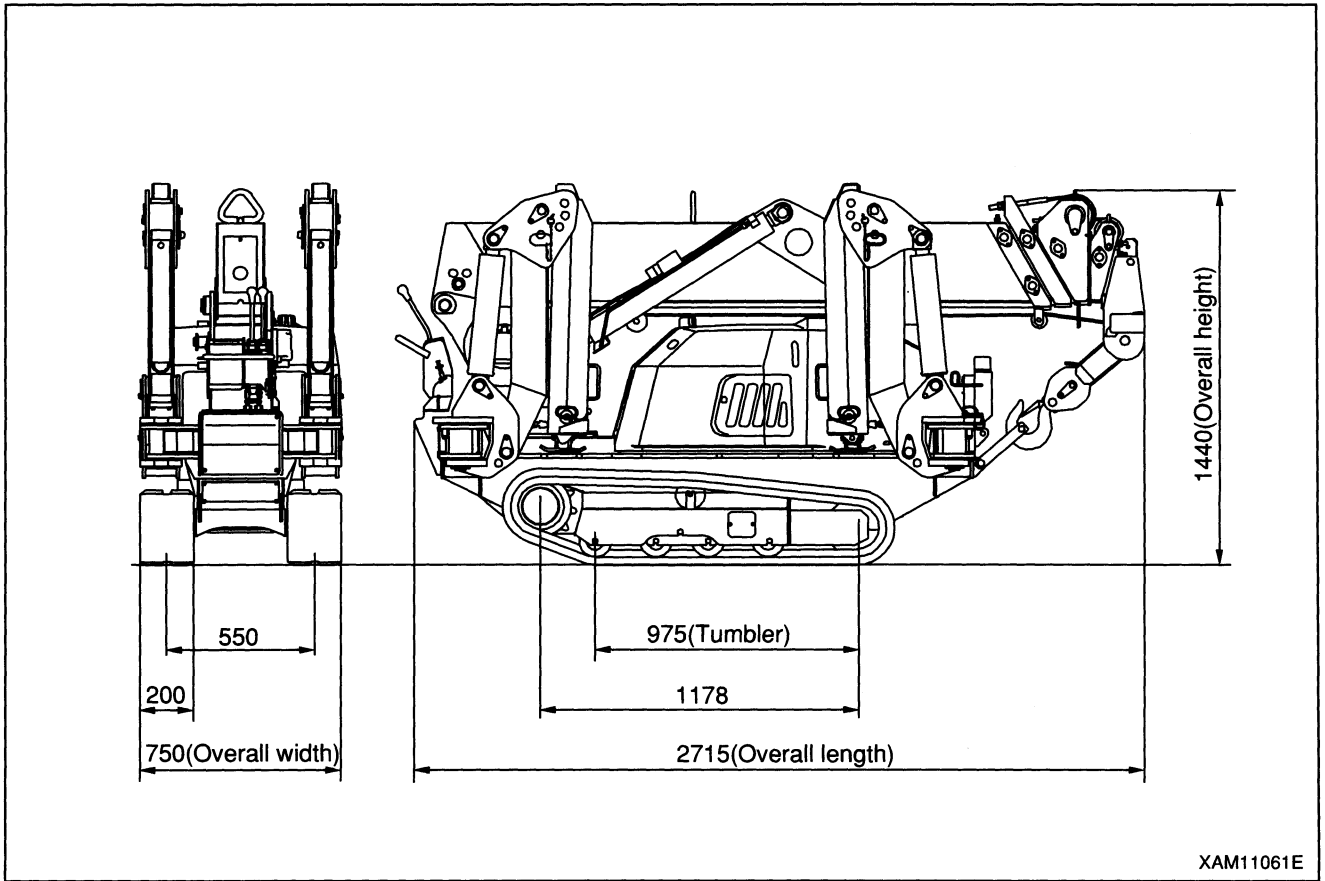

★ The above drawing shows the machine with its travel lever stand in Hauling position

1.3 Rated total road table

MC-285C Rated Total Load Table							
Rated Total Load with Outrigger Extended to Maximum							
2.535m/4.075m boom		5.575m boom		7.075m boom		8.575m boom	
Working radius (m)	Rated Total Load (t)	Working radius (m)	Rated Total Load (t)	Working radius (m)	Rated Total Load (t)	Working radius (m)	Rated Total Load (t)
1.4 below	2.82	3.0 below	1.22	3.6 below	0.82	4.0 below	0.55
1.5	2.52	3.5	0.97	4.0	0.74	4.5	0.4
2.0	1.92	4.0	0.78	4.5	0.58	5.0	0.34
2.5	1.57	4.5	0.63	5.0	0.48	5.5	0.3
3.0	1.22	5.0	0.53	5.5	0.43	6.0	0.27
3.5	0.97	5.205	0.53	6.0	0.38	6.5	0.23
3.705	0.92			6.5	0.35	7.0	0.2
				6.705	0.33	7.5	0.18
						8.0	0.15
						8.205	0.15
Rated Total Load of Outrigger Extended to other than Maximum							
2.535m/4.075m boom		5.575m boom		7.075m boom		8.575m boom	
Working radius (m)	Rated Total Load (t)	Working radius (m)	Rated Total Load (t)	Working radius (m)	Rated Total Load (t)	Working radius (m)	Rated Total Load (t)
1.5 below	1.72	3.0 below	0.51	3.6 below	0.4	4.0 below	0.33
2.0	1.07	3.5	0.41	4.0	0.33	4.5	0.28
2.5	0.63	4.0	0.33	4.5	0.28	5.0	0.23
3.0	0.52	4.5	0.28	5.0	0.23	5.5	0.18
3.5	0.43	5.0	0.23	5.5	0.18	6.0	0.16
3.705	0.35	5.205	0.2	6.0	0.16	6.5	0.15
				6.5	0.15	7.0	0.1
				6.705	0.14	7.5	0.08
						8.0	0.07
						8.205	0.06

XAM11070E

1.4 Working radius – lifting height chart

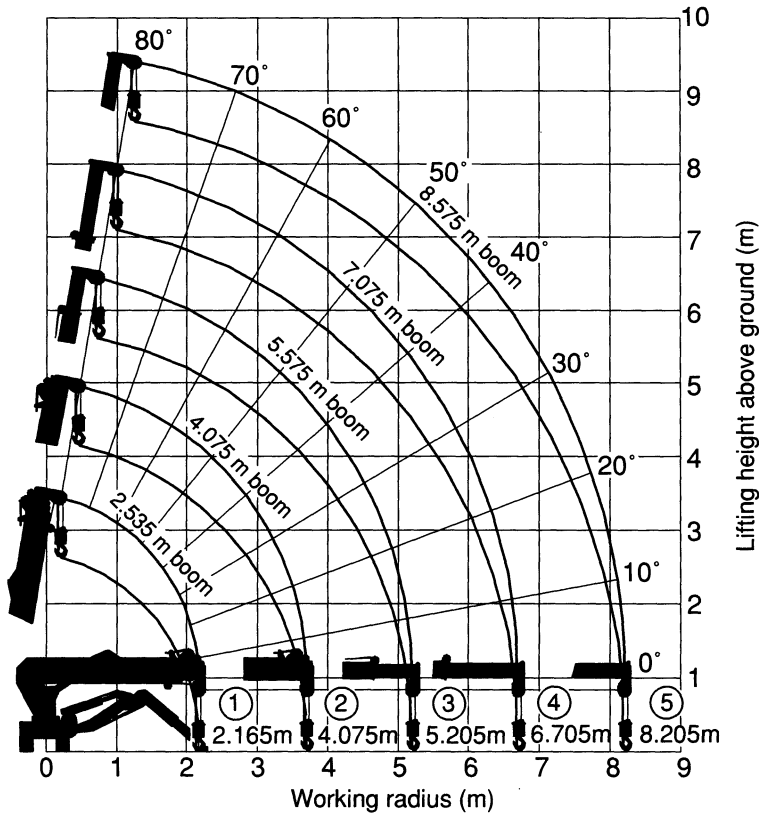

XAM09460E

**MAEDA MINI-CRAWLER CRANE MC-285C OPERATION MANUAL**

---

Document No.353ME-OM0511-02

Issued by : Maeda Seisakusho Co., Ltd.

1095 Shinonoi Onbegawa , Nagano City , Nagano , 388-8522 Japan

---

All rights reserved.







**M A E D A**